

## Design Example Report

<b>Title</b>	<i>45 W USB PD Power Supply Using InnoSwitch™-3 CP INN3268C and Cypress CYPD 2134 USB-PD controller</i>
<b>Specification</b>	85 VAC – 265 VAC Input; 5 V, 3 A; 9 V, 3 A; 15 V, 3 A Outputs
<b>Application</b>	USB-PD Charger
<b>Author</b>	Applications Engineering Department
<b>Document Number</b>	DER-536
<b>Date</b>	September 9, 2017
<b>Revision</b>	1.0

### Summary and Features

- InnoSwitch3-CP is the industry's first AC/DC IC with isolated, safety rated integrated feedback
- All the benefits of secondary-side control with the simplicity of primary-side regulation
  - Insensitive to transformer variation
- Built in synchronous rectification for high efficiency
- Meets DOE6 and CoC V5 2016 with at least 1.4% margin
- <30 mW no-load input power across line
- Load regulation  $\leq 2.5\%$
- Integrated thermal protection: passes thermals under ambient conditions of 45 °C
- Primary sensed overvoltage protection
- Design thickness  $\leq 10$  mm without the enclosure
- Planar transformer construction

### PATENT INFORMATION

The products and applications illustrated herein (including transformer construction and circuits external to the products) may be covered by one or more U.S. and foreign patents, or potentially by pending U.S. and foreign patent applications assigned to Power Integrations. A complete list of Power Integrations' patents may be found at [www.powerint.com](http://www.powerint.com). Power Integrations grants its customers a license under certain patent rights as set forth at < <https://www.power.com/company/intellectual-property-licensing/> >.

## Table of Contents

1	Introduction .....	4
2	Power Supply Specification .....	5
3	Schematic .....	6
4	Circuit Description .....	7
4.1	Input EMI Filtering.....	7
4.2	InnoSwitch IC Primary .....	7
4.3	InnoSwitch IC Secondary .....	7
4.4	USB Type-C and PD Interface .....	9
5	PCB Layout.....	10
6	Bill of Materials .....	12
7	Design Spreadsheet .....	14
8	Drawings.....	18
8.1	Enclosure.....	18
8.2	Heat Spreader Aluminum .....	22
8.3	Heat Spreader Tape Stencil .....	23
8.4	Heat Spreader Bending Tool.....	24
9	Magnetics Specification.....	25
9.1	Transformer .....	25
9.1.1	Electrical Diagram .....	25
9.1.2	Transformer Cross Sectional Stack-Up View.....	25
9.1.3	Modified Core Details .....	26
9.1.4	Transformer Parameters.....	27
9.1.6	Transformer Stack-Up .....	28
9.1.7	Planar PCB Layout.....	29
9.2	Common Mode Choke.....	31
9.2.1	34 mH Common Mode Choke.....	31
9.2.2	600 $\mu$ H Common Mode Choke.....	33
10	Power Supply Assembly Instructions.....	35
10.1	Input Filter.....	35
10.1.1	Schematic .....	35
10.1.2	Material List.....	35
10.1.3	Construction .....	36
10.2	Planar Transformer.....	40
10.2.1	Material List.....	40
10.2.2	Construction .....	41
10.3	Heat Spreader .....	48
10.3.1	Material List.....	48
10.3.2	Construction .....	48
10.4	Heat Spreader Tape.....	55
10.4.1	Material List.....	55
10.4.2	Construction .....	55
11	Performance Data.....	60



11.1	Efficiency .....	60
11.1.1	Test Set-up.....	60
11.1.2	Test Data .....	60
11.2	No-Load Input Power with Type-C Cable Disconnected .....	69
11.2.1	Test Set-up.....	69
11.2.2	Test Data .....	69
11.3	Load Regulation .....	70
11.3.1	Test Set-up.....	70
11.3.2	Test Data .....	71
11.4	Thermal Performance.....	83
11.4.1	Test Set-up.....	83
11.4.2	Test Data .....	84
11.5	Output Ripple Measurements.....	88
11.5.1	Test Set-up.....	88
11.5.2	Test Data .....	89
12	Waveforms.....	92
12.1	Switching Waveforms.....	92
12.1.1	Primary Drain and Current .....	92
12.1.2	Steady-State Secondary Drain Voltage .....	96
12.1.3	Transient Secondary Drain Voltage .....	99
12.1.4	Load Transient Response .....	101
12.1.5	CVCC Profile .....	105
13	Conducted EMI .....	108
13.1	Test Set-up .....	108
13.2	Test Data.....	108
13.2.1	Line = 115 VAC.....	108
13.2.2	Line = 230 VAC.....	111
14	Surge Testing .....	114
14.1	Test Set-up .....	114
14.2	Test Data.....	114
14.2.1	Combination Wave Differential Surge Test.....	114
15	Revision History .....	115

**Important Note:**

Although this board is designed to satisfy safety isolation requirements, the engineering prototype has not been agency approved. Therefore, all testing should be performed using an isolation transformer to provide the AC input to the prototype board.



## 1 Introduction

This document is an engineering report describing a 15 V / 3 A, 9 V / 3 A and 5 V / 3 A output USB Type-C and USB PD charger using the InnoSwitch3-CP INN3268C and Cypress CYPD2134 Type-C USB PD controller. This design shows the high power density and efficiency that is possible due to the high level of integration of the InnoSwitch3-CP controller providing exceptional performance.

This document contains the power supply specification, schematic, bill of materials, transformer documentation, printed circuit layout, safety and performance data

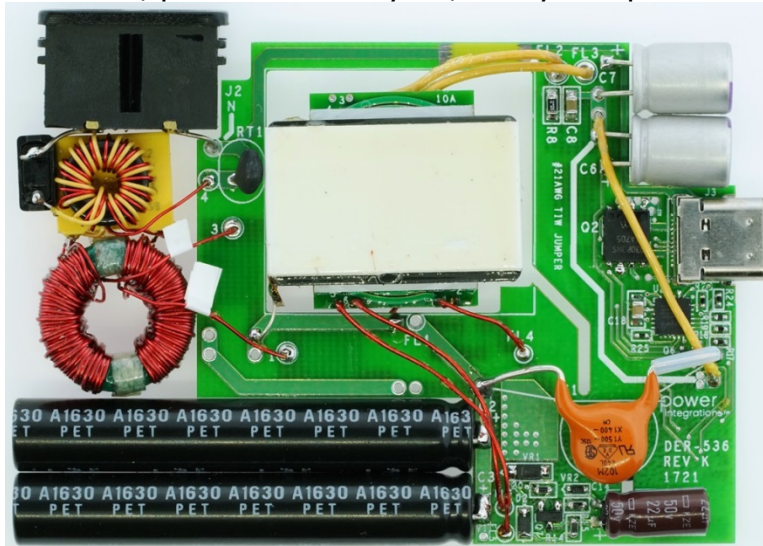


Figure 1 – Populated Circuit Board Photograph, Top.

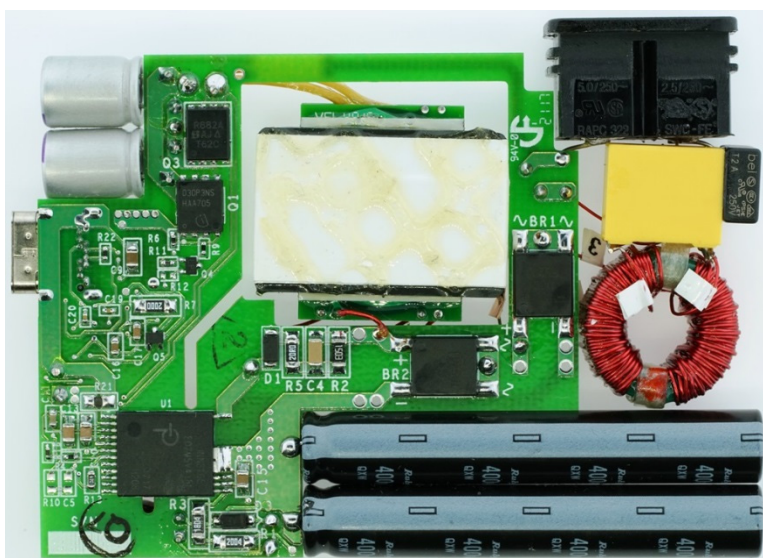


Figure 2 – Populated Circuit Board Photograph, Bottom.



## 2 Power Supply Specification

The table below represents the minimum acceptable performance of the design. Actual performance is listed in the results section.

Description	Symbol	Min	Typ	Max	Units	Comment
<b>Input</b>						
Voltage	$V_{IN}$	85		265	VAC	2 Wire – no P.E.
Frequency	$f_{LINE}$	47	50/60	63	Hz	
No-load Input Power (230 VAC)				27.5	mW	Measured at 230 VAC with the Type-C Cable Disconnected.
<b>5 V Output</b>						
Output Voltage	$V_{OUT1}$		5		V	±5%
Output Ripple Voltage	$V_{RIPPLE1}$			150	mV	At End of Cable. Cable Needs a Resistance of 100 mΩ. 20 MHz Bandwidth.
Output Current	$I_{OUT1}$		3.0	3.5	A	
Efficiency (DoE Average)	$\eta$	88.6%				
Efficiency (CoC Average)	$\eta$	88.0%				Average /10% Efficiency Measured at the Type-C Receptacle on the Board for 115 / 230 VAC.
Efficiency (CoC 10% Load)	$\eta$	84.5%				
<b>9 V Output</b>						
Output Voltage	$V_{OUT2}$		9		V	±5%
Output Ripple Voltage	$V_{RIPPLE2}$			200	mV	At End of Cable. Cable Needs a Resistance of 100 mΩ. 20 MHz Bandwidth.
Output Current	$I_{OUT2}$		3	3.5	A	
Efficiency (DoE Average)		89.4%				
Efficiency (CoC Average)		89.7%				Average /10% Efficiency Measured at the Type-C Receptacle on the Board for 115 / 230 VAC.
Efficiency (CoC 10% Load)	$\eta$	85.3%				
<b>15 V Output</b>						
Output Voltage	$V_{OUT3}$		15		V	±5%
Output Ripple Voltage	$V_{RIPPLE3}$			300	mV	At End of Cable. Cable Needs a Resistance of 100 mΩ. 20 MHz Bandwidth.
Output Current	$I_{OUT3}$		3	3.5	A	
Efficiency (DoE Average)		89.7%				
Efficiency (CoC Average)		90.5%				Average /10% Efficiency Measured at the Type-C Receptacle on the Board for 115 / 230 VAC.
Efficiency (CoC 10% Load)	$\eta$	85.7%				
Continuous Output Power	$P_{OUT}$			45	W	
Conducted EMI						Meets CISPR22B / EN55022B
Safety						
Ambient Temperature	$T_{AMB}$	0		45	°C	Free Convection, Sea Level.

**Note:** To use this design for a charger/adaptor, circuit board would need to be modified depending on shape and form factor of the housing. ESD and Line surge performance should be evaluated and layout adjusted to meet the target specification.

### 3 Schematic

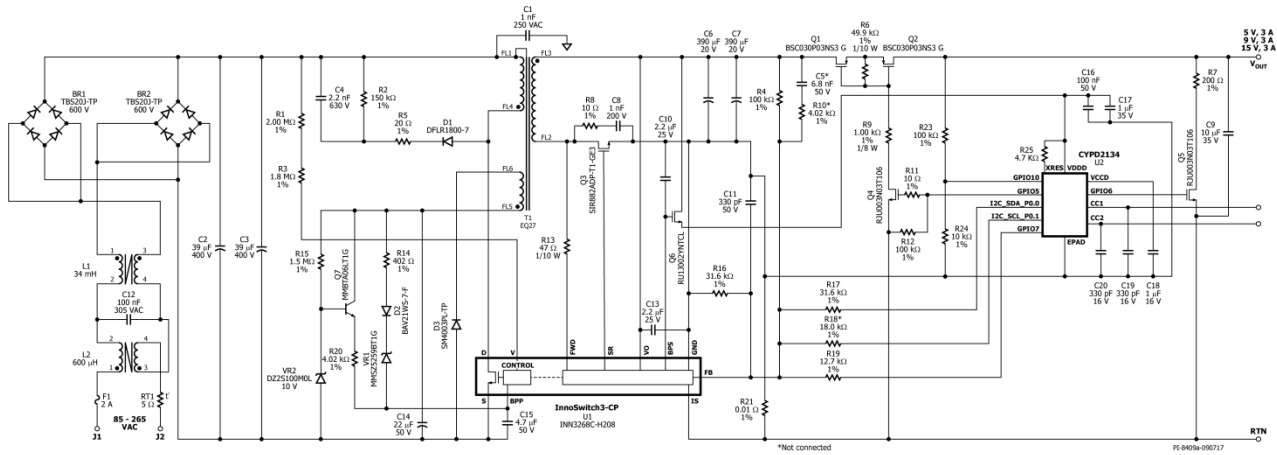


Figure 3 – Schematic.

Note: Do not populate C5, R10, R18.



## 4 Circuit Description

### 4.1 Input EMI Filtering

Common mode choke L1 and L2 provides attenuation for EMI. Bridge rectifier BR1 and BR2 rectify the AC line voltage and provides a full wave rectified DC. Thermistor RT1 limits the inrush current when the power supply is connected to the input AC supply. Fuse F1 isolates the circuit and provides protection from component failure.

### 4.2 InnoSwitch IC Primary

One end of the transformer primary is connected to the rectified DC bus; the other is connected to the drain terminal of the MOSFET inside the InnoSwitch3-CP IC (U1).

A low cost RCD clamp formed by diode D1, resistors R2 and R5 and capacitor C4 limits the peak drain voltage of U1 at the instant of turn off of the MOSFET inside U1. The clamp helps to dissipate the energy stored in the leakage reactance of transformer T1.

The IC is self-starting, using an internal high-voltage current source to charge the BPP pin capacitor (C15) when AC is first applied. During normal operation the primary side block is powered from an auxiliary winding on the transformer T1. Output of the auxiliary (or bias) winding is rectified using diode D3 and filtered using capacitor C14. Resistor R15 and R20 along with Q7 and VR2 form a linear regulator circuit to limit the current being supplied to the BPP pin of the InnoSwitch3-CP IC (U1) irrespective of the output voltage. The Zener VR1 along with resistor R14 and diode D2 provides latching OVP for output overvoltage condition.

In a flyback converter, output of the auxiliary winding tracks the output voltage of the converter. In case of over voltage at output of the converter, the auxiliary winding voltage increases and causes breakdown of VR1 which then causes a current to flow into the BPP pin of InnoSwitch3-CP IC U1. If the current flowing into the BPP pin increases above the  $I_{SD}$  threshold, the InnoSwitch-CP controller will latch off and prevent any further increase in output voltage.

### 4.3 InnoSwitch IC Secondary

The secondary-side of the InnoSwitch3-CP IC provides output voltage, output current sensing and drive to a MOSFET providing synchronous rectification. The secondary of the transformer is rectified by MOSFET Q3 and filtered by capacitors C6 and C7. High frequency ringing during switching transients that would otherwise create radiated EMI is reduced via a RC snubber, R8 and C8.

The gate of Q3 is turned on by secondary-side controller inside IC U1, based on the winding voltage sensed via resistor R13 and fed into the FWD pin of the IC.

In continuous conduction mode of operation, the MOSFET is turned off just prior to the secondary-side commanding a new switching cycle from the primary. In discontinuous or continuous mode of operation, the power MOSFET is turned off when the voltage drop across the MOSFET falls below a threshold. Secondary-side control of the primary side power MOSFET avoids any possibility of cross conduction of the two MOSFETs and provides extremely reliable synchronous rectification.

The secondary-side of the IC is self-powered from either the secondary winding forward voltage or the output voltage. Capacitor C10, connected to the BPS pin of InnoSwitch-CP IC U1 provides decoupling for the internal circuitry.

During CC operation, when the output voltage falls, the device will power itself from the secondary winding directly. During the on-time of the primary side power MOSFET, the forward voltage that appears across the secondary winding is used to charge the decoupling capacitor C10 via resistor R13 and an internal regulator. This allows output current regulation to be maintained down to  $\sim 3.4$  V. Below this level the unit enters auto-restart until the output load is reduced.

Output current is sensed by monitoring the voltage drop across resistor R21 between the IS and GND pins with a threshold of approximately 35 mV to reduce losses. Once the internal current sense threshold is exceeded the device adjusts the number of switch pulses to maintain a fixed output current.

Below the CC threshold, the device operates in constant voltage mode. Output voltage is regulated so as to achieve a voltage of 1.265 V on the FB pin. Capacitor C11 provides noise filtering of the signal at the FB pin.

#### ***4.4 USB Type-C and PD Interface***

In this design, Cypress CYPD2134 (U2) is the USB Type-C and PD controller. Output of the InnoSwitch3-CP based flyback power converter stage powers the Cypress device through its VCC pin.

Resistors R23 and R24 of the PD controller stage senses the output of flyback power stage secondary-side to provide voltage feedback to the PD controller. Output voltage is changed to 15 V, 9 V or 5 V when sink requests for the same. To change the output to 15 V, pin-1 of IC U2 goes low and adds resistor R19 in parallel to the bottom resistor of the feedback divider network.

USB PD protocol is communicated over either CC1 or CC2 line depending on the orientation in which Type-C plug is connected.

P-MOSFETS Q1 and Q2 make the USB Type-C receptacle cold socket when no device is attached to the charger as per the USB Type-C specification.

### 5 PCB Layout

PCB copper thickness is 2.0 oz.

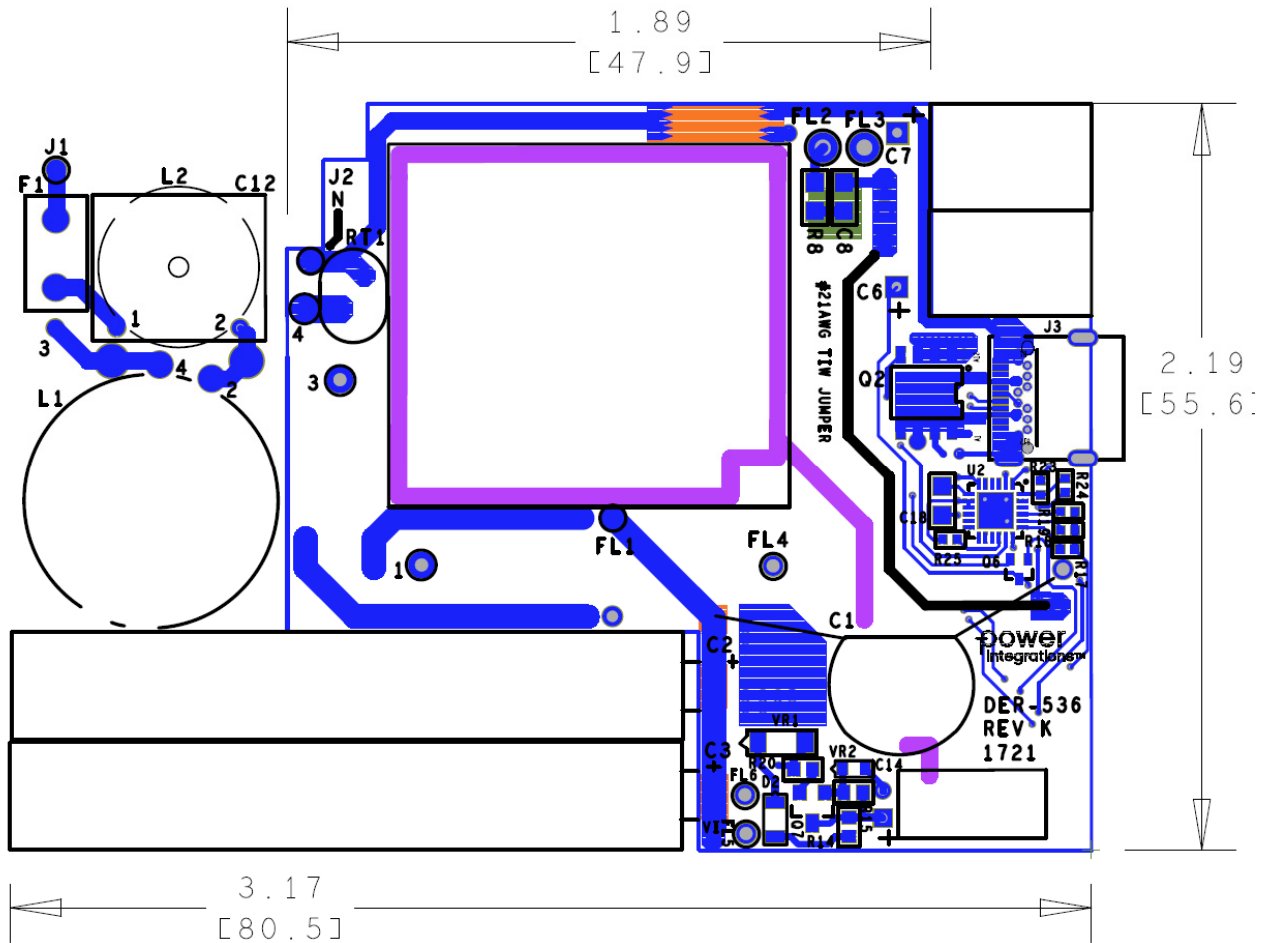


Figure 4 – Printed Circuit Layout, Top.





## 6 Bill of Materials

Item	Qty	Ref Des	Description	Mfg Part Number	Manufacturer
1	2	BR1 BR2	BRIDGE RECT, 2 A 600 V, TBS-1,	TBS20J-TP	Micro Commercial
2	1	C1	1 nF, Ceramic, Y1	440LD10-R	Vishay
3	2	C2 C3	39 $\mu$ F, 400 V, 20%,Electrolytic, (8 x 50),Radial, Can, 2000 Hrs @ 105°C,	400QXW39MEFR8X50	Rubycon
4	1	C4	2.2 nF, 630 V, Ceramic, X7R, 1206	C3216X7R2J222K	TDK
5	1	C5	6.8 nF 50 V, Ceramic, X7R, 0603	CC0603KRX7R9BB682	Yageo
6	2	C6 C7	390 $\mu$ F, 20 V, Polymer, Gen. Purpose, (8 x 12)	20SEPF390M	Panasonic
7	1	C8	1 nF, 200 V, Ceramic, X7R, 0805	08052C102KAT2A	AVX
8	1	C9	10 $\mu$ F, 35 V, Ceramic, X5R, 0805	C2012X5R1V106K085AC	TDK
9	2	C10 C13	2.2 $\mu$ F, 25 V, Ceramic, X7R, 0805	C2012X7R1E225M	TDK
10	1	C11	330 pF 50 V, Ceramic, X7R, 0603	CC0603KRX7R9BB331	Yageo
11	1	C12	100 nF, 305 VAC, Polypropylene Film, X2	MK61104-P24M	Sichuan Zhongxing
12	1	C14	22 $\mu$ F, 50 V, Electrolytic, Very Low ESR, 340 m $\Omega$ , (5 x 11)	EKZE500ELL220ME11D	Nippon Chemi-Con
13	1	C15	4.7 $\mu$ F, 50 V, Ceramic, X5R, 0805	CL21A475KBQNNNE	Samsung
14	1	C16	100 nF 50 V, Ceramic, X7R, 0603	C1608X7R1H104K	TDK
15	1	C17	1 $\mu$ F 35 V, Ceramic, X7R, 0603	C1608X7R1V105M	TDK
16	1	C18	CAP, CER, 1 $\mu$ F, 16 V, X7R, 0805	GRM21BR71C105KA01K	Murata
17	2	C19 C20	330 pF 16 V, Ceramic, X7R, 0402	C0402C331K4RACTU	Kemet
18	1	D1	800 V, 1 A, Rectifier, POWERDI123	DFLR1800-7	Diodes, Inc.
19	1	D2	250 V, 0.2 A, Fast Switching, 50 ns, SOD-323	BAV21WS-7-F	Diodes, Inc.
20	1	D3	200V, 1 A, Standard Recovery, SOD-123FL	SM4003PL-TP	Micro Commercial
21	1	F1	2 A, 250 V, Slow, Long Time Lag, RST	RST 2	Belfuse
22	4	FL1 FL4 FL5 FL6	Flying Lead , Hole size 30mils	N/A	N/A
23	2	FL2 FL3	Flying Lead, Hole size 50mils	N/A	N/A
24	2	J1 J2	PCB Terminal Hole, 30 AWG	N/A	N/A
25	1	J3	USB 3.1 CF STD CL1. 75- H3.45 mm type 1.20 mm	A32-0XS1-X12	ShenZhen Ai Lian Electronics
26	1	L1	34 mH, Toroidal Common Mode Choke, custom	32-00345-00	Power Integrations
27	1	L2	600 $\mu$ H, Toroidal Common Mode Choke, custom, DER-536, wound on 32-00275-00 core	32-00347-00	Power Integrations
28	2	Q1 Q2	30 V, 100 A, P-Channel, TSDSON-8	BSC030P03NS3 G	Infineon
29	1	Q3	100 V, 60 A, 8.7 m $\Omega$ , N-Channel, PowerPAK SO-8	SIR882ADP-T1-GE3	Vishay
30	2	Q4 Q5	MOSFET, N-CH, 30 V, 300 mA, SOT-323	RJU003N03T106	Rohm
31	1	Q6	MOSFET, N-CH, 50 V, 0.2 A, UMT3F, SC-85	RU1J002YNTCL	Rohm
32	1	Q7	NPN, Small Signal BJT, 80 V, 0.5 A, SOT-23	MMBTA06LT1G	On Semi
33	1	R1	RES, 2.00 M $\Omega$ , 1%, 1/4 W, Thick Film, 1206	ERJ-8ENF2004V	Panasonic
34	1	R2	RES, 150 k $\Omega$ , 1%, 1/4 W, Thick Film, 1206	ERJ-8ENF1503V	Panasonic
35	1	R3	RES, 1.80 M $\Omega$ , 1%, 1/4 W, Thick Film, 1206	ERJ-8ENF1804V	Panasonic
36	3	R4 R12 R23	RES, 100.0 k $\Omega$ , 1%, 1/10 W, Thick Film, 0402	ERJ-2RKF1003X	Panasonic
37	1	R5	RES, 20 $\Omega$ , 1%, 1/4 W, Thick Film, 1206	ERJ-8ENF20R0V	Panasonic
38	1	R6	RES, 49.9 k $\Omega$ , 1%, 1/10 W, Thick Film, 0402	ERJ-2RKF4992X	Panasonic
39	1	R7	RES, 200 $\Omega$ , 1%, 1/4 W, Thick Film, 1206	ERJ-8ENF2000V	Panasonic
40	1	R8	RES, 10 $\Omega$ , 1%, 1/8 W, Thick Film, 0805	ERJ-6ENF10R0V	Panasonic
41	1	R9	RES, 1.00 k $\Omega$ , 1%, 1/10 W, Thick Film, 0402	ERJ-2RKF1001X	Panasonic
42	2	R10 R20	RES, 4.02 k $\Omega$ , 1%, 1/16 W, Thick Film, 0603	ERJ-3EKF4021V	Panasonic
43	1	R11	RES, 10 $\Omega$ , 5%, 1/10 W, Thick Film, 0402	ERJ-2GEJ100X	Panasonic
44	1	R13	RES, 47 $\Omega$ , 5%, 1/10 W, Thick Film, 0603	ERJ-3GEYJ470V	Panasonic
45	1	R14	RES, 402 $\Omega$ , 1%, 1/16 W, Thick Film, 0603	ERJ-3EKF4020V	Panasonic
46	1	R15	RES, 1.50 M $\Omega$ , 1%, 1/16 W, Thick Film, 0603	ERJ-3EKF1504V	Panasonic
47	2	R16 R17	RES, 31.6 k $\Omega$ , 1%, 1/10 W, Thick Film, 0402	ERJ-2RKF3162X	Panasonic
48	1	R18	RES, 18.0 k $\Omega$ , 1%, 1/10 W, Thick Film, 0402	ERJ-2RKF1802X	Panasonic



49	1	R19	RES, 12.7 k $\Omega$ , 1%, 1/10 W, Thick Film, 0402	ERJ-2RKF1272X	Panasonic
50	1	R21	RES, 0.01 $\Omega$ , 0.4 W, 1%, 0805	PF0805FRM7W0R01L	Yageo
51	1	R22	RES, 100 $\Omega$ , 5%, 1/10 W, Thick Film, 0402	ERJ-2GEJ101X	Panasonic
52	1	R24	RES, 10.0 k $\Omega$ , 1%, 1/16 W, Thick Film, 0402	RC0402FR-0710KL	Yageo
53	1	R25	RES, 4.7 k $\Omega$ , 5%, 1/10 W, Thick Film, 0402	ERJ-2GEJ472X	Panasonic
54	1	RT1	NTC Thermistor, 5 $\Omega$ , 1 A	MF72-005D5	Cantherm
55	1	T1	Transformer, Planar, 9 pins, Custom, Pri 23T_CT, Sec 3T_CT, Bias 3T_CT	25-01125-00	PI
56	1	U1	InnoSwitch3-CP H208, InSOP24D	INN3268C-H208	Power Integrations
57	1	U2	IC, USB Type-C Port Controller	CYPD2134-24LQXIT	Cypress
58	1	VR1	DIODE ZENER 39 V 500 mW SOD123	MMSZ5259BT1G	ON Semi
59	1	VR2	10 V, 5%, 150 mW, SSMINI-2	DZ2S100MOL	Panasonic



## 7 Design Spreadsheet

ACDC_InnoSwitch3-CP_Flyback_083017; Rev.1.0; Copyright Power Integrations 2017	INPUT	INFO	OUTPUT	UNITS	InnoSwitch3-CP Flyback Design Spreadsheet
<b>APPLICATION VARIABLES</b>					
VAC_MIN			85	V	Minimum AC line voltage
VAC_MAX			265	V	Maximum AC input voltage
VAC_RANGE			UNIVERSAL		AC line voltage range
FLINE			60	Hz	AC line voltage frequency
CAP_INPUT	78.0		78.0	uF	Input capacitance
<b>SETPOINT 1</b>					
VOUT1	15.00		15.00	V	Output voltage 1, should be the highest output voltage required
IOUT1	3.00		3.00	A	Output current 1
POUT1			45.00	W	Output power 1
EFFICIENCY1	0.90		0.90		Converter efficiency for output 1
Z_FACTOR1	0.50		0.50		Z-factor for output 1
<b>SETPOINT 2</b>					
VOUT2	9.00		9.00	V	Output voltage 2
IOUT2	3.00		3.00	A	Output current 2
POUT2			27.00	W	Output power 2
EFFICIENCY2	0.90		0.90		Converter efficiency for output 2
Z_FACTOR2	0.50		0.50		Z-factor for output 2
<b>SETPOINT 3</b>					
VOUT3	5.00		5.00	V	Output voltage 3
IOUT3	3.00		3.00	A	Output current 3
POUT3			15.00	W	Output power 3
EFFICIENCY3	0.89		0.89		Converter efficiency for output 3
Z_FACTOR3	0.50		0.50		Z-factor for output 3
<b>SETPOINT 4</b>					
VOUT4			0.00	V	Output voltage 4
IOUT4			0.00	A	Output current 4
POUT4			0.00	W	Output power 4
EFFICIENCY4			0.00		Converter efficiency for output 4
Z_FACTOR4			0.00		Z-factor for output 4
<b>SETPOINT 5</b>					
VOUT5			0.00	V	Output voltage 5
IOUT5			0.00	A	Output current 5
POUT5			0.00	W	Output power 5
EFFICIENCY5			0.00		Converter efficiency for output 5
Z_FACTOR5			0.00		Z-factor for output 5
<b>SETPOINT 6</b>					
VOUT6			0.00	V	Output voltage 6
IOUT6			0.00	A	Output current 6
POUT6			0.00	W	Output power 6
EFFICIENCY6			0.00		Converter efficiency for output 6
Z_FACTOR6			0.00		Z-factor for output 6
<b>SETPOINT 7</b>					
VOUT7			0.00	V	Output voltage 7
IOUT7			0.00	A	Output current 7
POUT7			0.00	W	Output power 7
EFFICIENCY7			0.00		Converter efficiency for output 7
Z_FACTOR7			0.00		Z-factor for output 7
<b>SETPOINT 8</b>					
VOUT8			0.00	V	Output voltage 8
IOUT8			0.00	A	Output current 8
POUT8			0.00	W	Output power 8
EFFICIENCY8			0.00		Converter efficiency for output 8
Z_FACTOR8			0.00		Z-factor for output 8



SETPOINT 9					
VOUT9			0.00	V	Output voltage 9
IOUT9			0.00	A	Output current 9
POUT9			0.00	W	Output power 9
EFFICIENCY9			0.00		Converter efficiency for output 9
Z_FACTOR9			0.00		Z-factor for output 9
PERCENT_CDC	0%		0%		Percentage (of output voltage) cable drop compensation desired at full load
CDC_SCALING_SETPOINT	3		3		Select the setpoint number for the voltage used for cable drop compensation (typically the 5V output)
PRIMARY CONTROLLER SELECTION					
ENCLOSURE	ADAPTER		ADAPTER		Power supply enclosure
ILIMIT_MODE	INCREASED		INCREASED		Device current limit mode
VBREAKDOWN_MOSFET	650		650	V	Device breakdown voltage
DEVICE_GENERIC	Auto		INN32X8		Device selection
DEVICE_CODE			INN3268C		Device code
PDEVICE_MAX			50	W	Device maximum power capability
RDSON_25DEG			0.99	$\Omega$	Primary MOSFET on-time resistance at 25°C
RDSON_100DEG			1.53	$\Omega$	Primary MOSFET on-time resistance at 100°C
ILIMIT_MIN			1.683	A	Primary MOSFET minimum current limit
ILIMIT_TYP			1.850	A	Primary MOSFET typical current limit
ILIMIT_MAX			2.017	A	Primary MOSFET maximum current limit
VDRAIN_ON_MOSFET			0.90	V	Primary MOSFET on-time voltage drop
VDRAIN_OFF_MOSFET			553.31	V	Peak drain voltage on the primary MOSFET during turn-off
WORST CASE ELECTRICAL PARAMETERS					
FSWITCHING_MAX	75000		75000	Hz	Maximum switching frequency at full load and the valley of the minimum input AC voltage
VOR	110.0		110.0	V	Voltage reflected to the primary winding (corresponding to setpoint 1) when the primary MOSFET turns off
VMIN			81.25	V	Valley of the minimum input AC voltage
KP			0.732		Measure of continuous/discontinuous mode of operation
MODE_OPERATION			CCM		Mode of operation
DUTYCYCLE			0.578		Primary MOSFET duty cycle
TIME_ON			11.35	us	Primary MOSFET on-time
TIME_OFF			5.63	us	Primary MOSFET off-time
LPRIMARY_MIN			510.1	uH	Minimum primary magnetizing inductance
LPRIMARY_TYP			536.9	uH	Typical primary magnetizing inductance
LPRIMARY_TOL			5.0		Primary magnetizing inductance tolerance
LPRIMARY_MAX			563.8	uH	Maximum primary magnetizing inductance
PRIMARY CURRENT					
I AVG_PRIMARY			0.59	A	Primary MOSFET average current
IPEAK_PRIMARY			1.86	A	Primary MOSFET peak current
IPEDESTAL_PRIMARY			0.43	A	Primary MOSFET current pedestal
IRIPPLE_PRIMARY			1.71	A	Primary MOSFET ripple current
IRMS_PRIMARY			0.86	A	Primary MOSFET RMS current
SECONDARY CURRENT					
IPEAK_SECONDARY			13.93	A	Secondary MOSFET peak current
IPEDESTAL_SECONDARY			3.24	A	Secondary MOSFET pedestal current
IRMS_SECONDARY			5.51	A	Secondary MOSFET RMS current
IRIPPLE_CAP_OUT			4.62	A	Output capacitor ripple current
TRANSFORMER CONSTRUCTION PARAMETERS					
CORE SELECTION					
CORE	Custom		Custom		Core selection
CORE NAME	EQ27		EQ27		Core code
AE	108.0		108.0	mm <sup>2</sup>	Core cross sectional area
LE	36.3		36.3	mm	Core magnetic path length

AL	7700		7700	nH	Ungapped core effective inductance per turns squared
VE	3920		3920	mm <sup>3</sup>	Core volume
BOBBIN NAME	Planar		Planar		Bobbin name
AW	52.0		52.0	mm <sup>2</sup>	Bobbin window area
BW	6.4		6.4	mm	Bobbin width
MARGIN			0.0	mm	Bobbin safety margin
<b>PRIMARY WINDING</b>					
NPRIMARY			30		Primary winding number of turns
BPEAK			3592	Gauss	Peak flux density
BMAX			3187	Gauss	Maximum flux density
BAC			1457	Gauss	AC flux density
ALG			597	nH	Typical gapped core effective inductance per turns squared
LG			0.210	mm	Core gap length
LAYERS_PRIMARY			2		Primary winding number of layers
AWG_PRIMARY			27		Primary wire gauge
OD_PRIMARY_INSULATED			0.418	mm	Primary wire insulated outer diameter
OD_PRIMARY_BARE			0.361	mm	Primary wire bare outer diameter
CMA_PRIMARY			234.4	Cmils/A	Primary winding wire CMA
<b>SECONDARY WINDING</b>					
NSECONDARY			4		Secondary winding number of turns
AWG_SECONDARY			19		Secondary wire gauge
OD_SECONDARY_INSULATED			1.217	mm	Secondary wire insulated outer diameter
OD_SECONDARY_BARE			0.912		Secondary wire bare outer diameter
CMA_SECONDARY			233.8	Cmils/A	Secondary winding wire CMA
<b>BIAS WINDING</b>					
NBIAS			10		Bias winding number of turns
<b>PRIMARY COMPONENTS SELECTION</b>					
<b>LINE UNDERVOLTAGE</b>					
BROWN-IN REQUIRED	65.00		65.00	V	Required line brown-in threshold
RLS			3.82	MΩ	Connect two 1.91 MOhm resistors to the V-pin for the required UV/OV threshold
BROWN-IN ACTUAL			65.15	V	Actual brown-in threshold using standard resistors
BROWN-OUT ACTUAL			59.78	V	Actual brown-out threshold using standard resistors
<b>LINE OVERVOLTAGE</b>					
OVERVOLTAGE_LINE			286.78	V	Actual line over-voltage threshold
<b>BIAS WINDING</b>					
VBIAS			12.00	V	Rectified bias voltage
VF_BIAS			0.70	V	Bias winding diode forward drop
VREVERSE_BIASDIODE			136.44	V	Bias diode reverse voltage (not accounting parasitic voltage ring)
CBIAS			22	uF	Bias winding rectification capacitor
CBPP			4.70	uF	BPP pin capacitor
<b>SECONDARY COMPONENTS SELECTION</b>					
<b>RECTIFIER</b>					
VDRAIN_OFF_SRFET			64.77	V	Secondary rectifier reverse voltage (not accounting parasitic voltage ring)
SRFET	Auto		SiR878ADP		Secondary rectifier (Logic MOSFET)
VBREAKDOWN_SRFET			100	V	Secondary rectifier breakdown voltage
RDSON_SRFET			18.0	mΩ	SRFET on time drain resistance at 25degC for VGS=4.4V
<b>FEEDBACK COMPONENTS</b>					
RFB_UPPER			100.00	kΩ	Upper feedback resistor (connected to the output terminal)
RFB_LOWER			34.00	kΩ	Lower feedback resistor required to obtain the output for cable drop compensation
CFB_LOWER			330	pF	Lower feedback resistor decoupling capacitor
<b>VARIABLE OUTPUTS ANALYSIS</b>					



TOLERANCE CORNER					
CORNER_VAC			85	V	Input AC RMS voltage corner to be evaluated
CORNER_ILIMIT	TYP		1.850	A	Current limit corner to be evaluated
CORNER_LPRIMARY	TYP		536.9	uH	Primary inductance corner to be evaluated
SETPOINT SELECTION					
SETPOINT	1		1		Select the setpoint which needs to be evaluated
FSWITCHING			60660.1	Hz	Maximum switching frequency at full load and the valley of the minimum input AC voltage
VOR			110.0	V	Voltage reflected to the primary winding when the primary MOSFET turns off
VMIN			81.25	V	Valley of the minimum input AC voltage
KP			0.821		Measure of continuous/discontinuous mode of operation
MODE_OPERATION			CCM		Mode of operation
DUTYCYCLE			0.578		Primary MOSFET duty cycle
TIME_ON			9.53	us	Primary controller's maximum on-time
TIME_OFF			6.96	us	Primary controller's minimum off-time
PRIMARY CURRENT					
I <sub>AVG_PRIMARY</sub>			0.59	A	Primary MOSFET average current
I <sub>PEAK_PRIMARY</sub>			1.74	A	Primary MOSFET peak current
I <sub>PEDESTAL_PRIMARY</sub>			0.31	A	Primary MOSFET current pedestal
I <sub>RIPPLE_PRIMARY</sub>			1.43	A	Primary MOSFET ripple current
I <sub>RMS_PRIMARY</sub>			0.84	A	Primary MOSFET RMS current
SECONDARY CURRENT					
I <sub>PEAK_SECONDARY</sub>			13.02	A	Secondary MOSFET peak current
I <sub>PEDESTAL_SECONDARY</sub>			2.33	A	Secondary MOSFET pedestal current
I <sub>RMS_SECONDARY</sub>			5.37	A	Secondary MOSFET RMS current
I <sub>RIPPLE_CAP_OUT</sub>			4.46	A	Output capacitor ripple current

## 8 Drawings

### 8.1 Enclosure

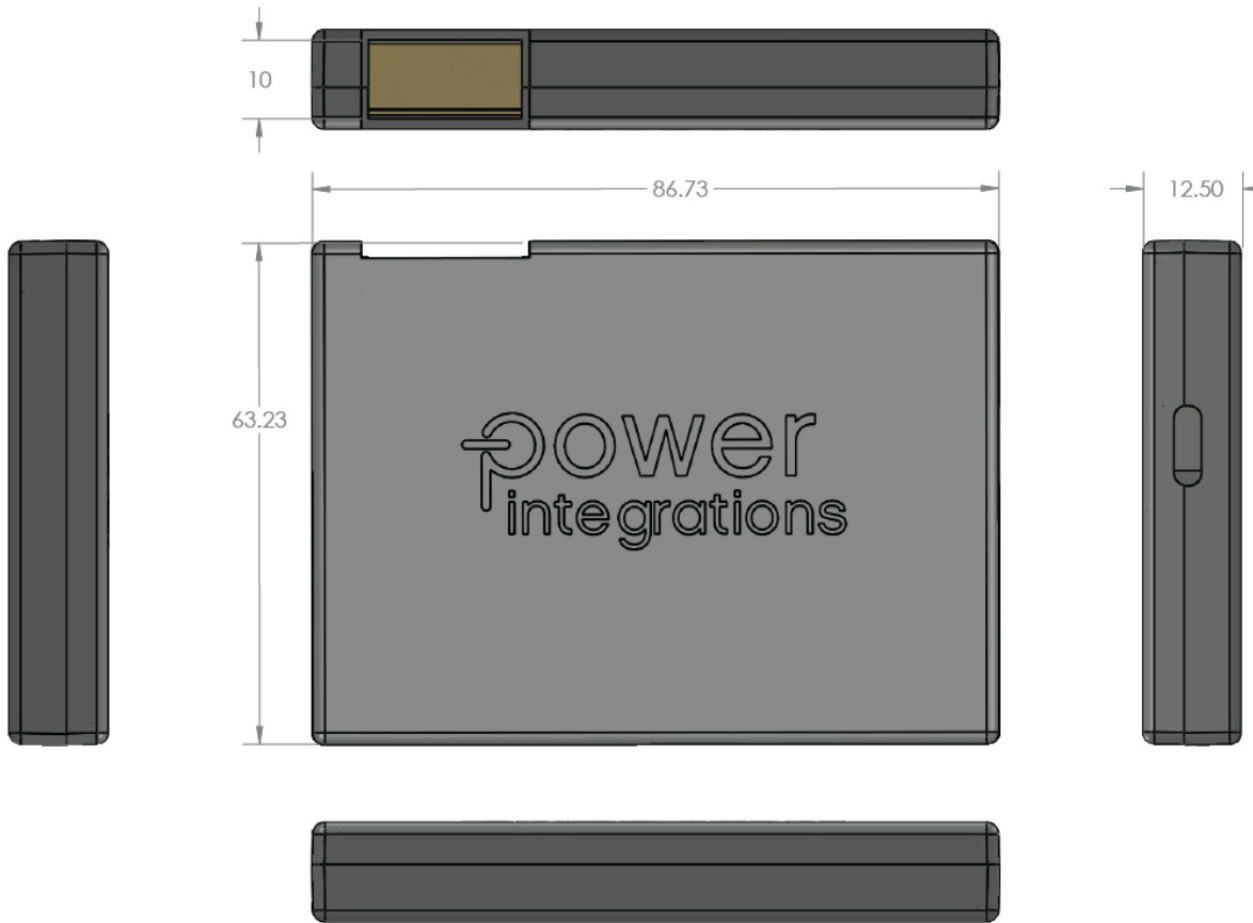


Figure 6 – Power Supply Enclosure Outer Dimensions.



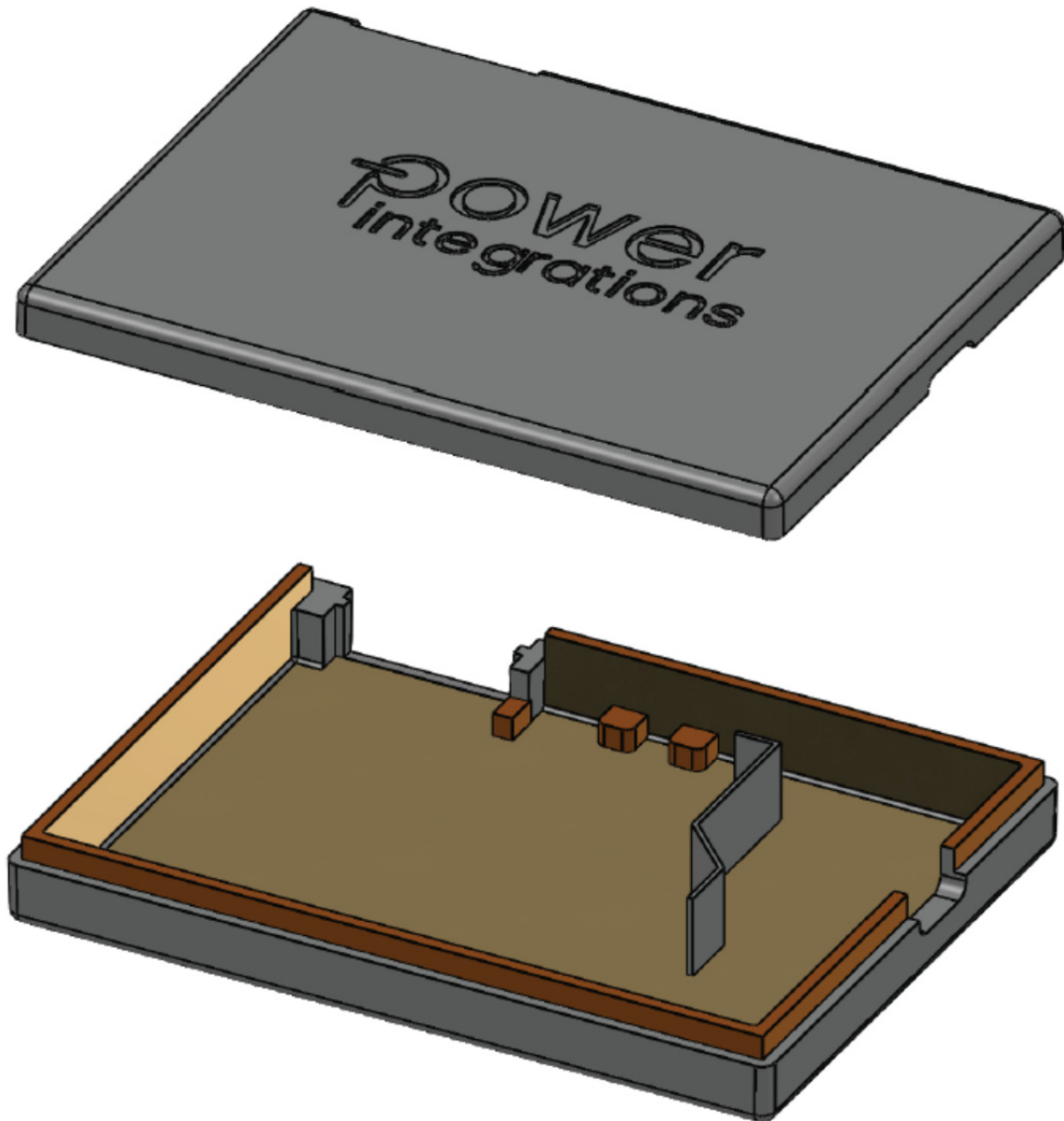


Figure 7 – Power Supply Enclosure Exploded View.

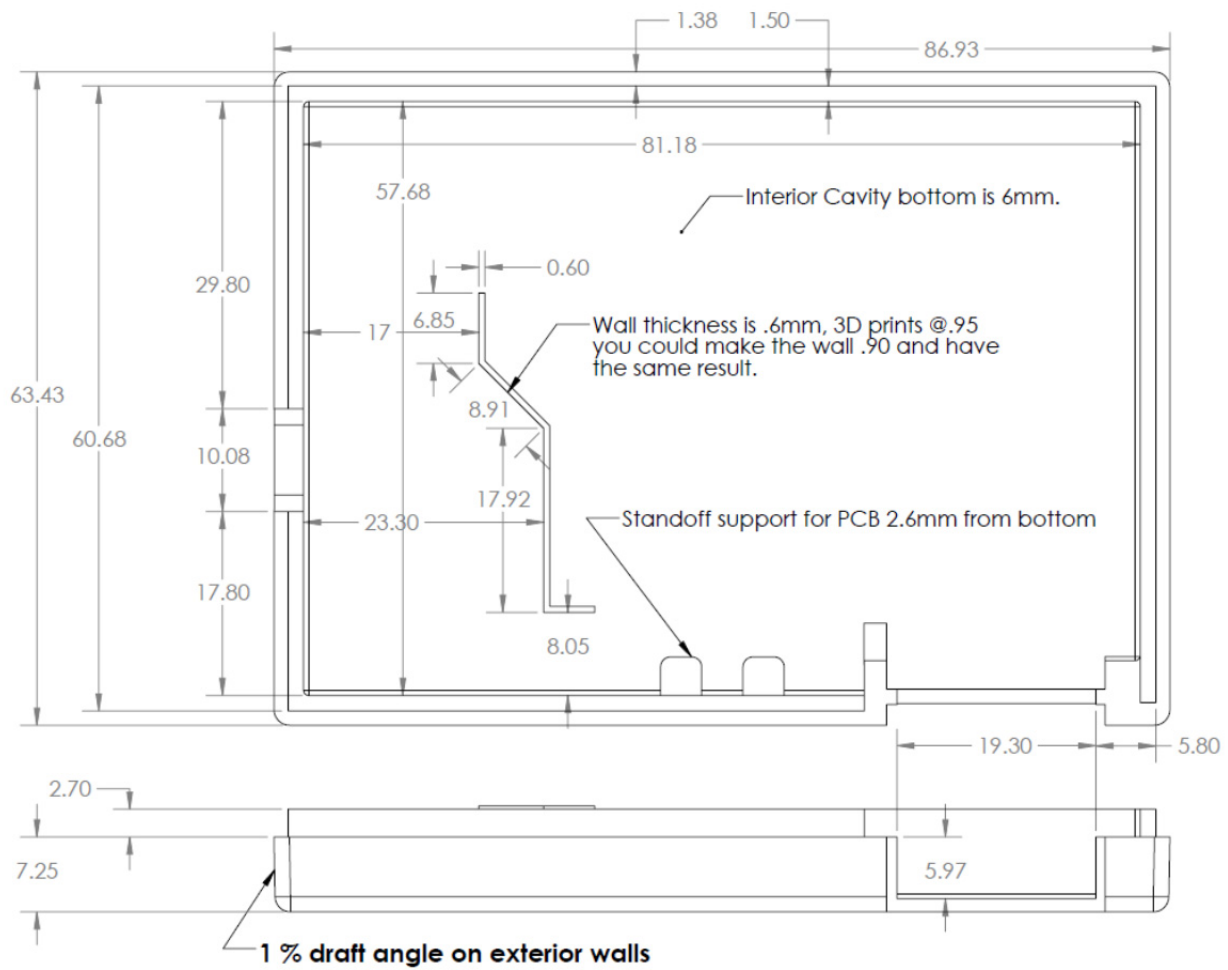
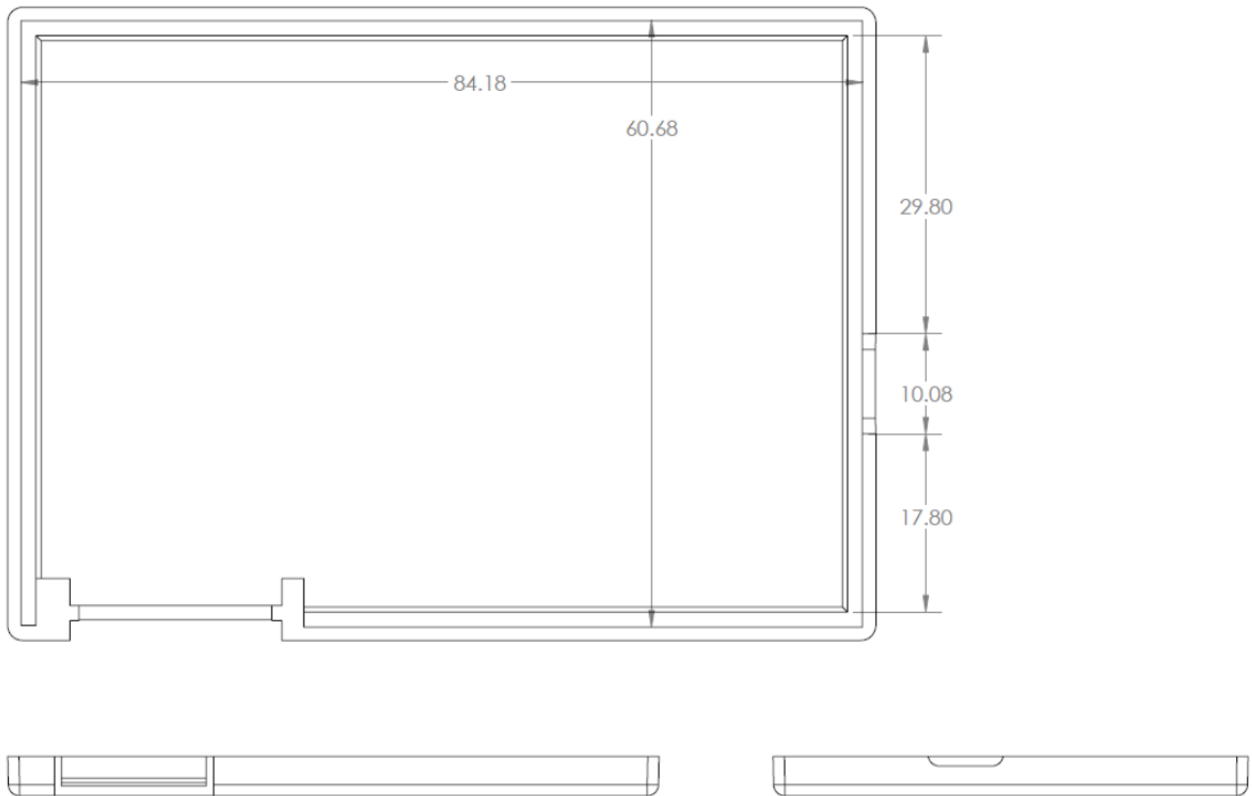


Figure 8 – Enclosure Bottom Dimensions.



**Figure 9 – Enclosure Top Dimensions.**

8.2 Heat Spreader Aluminum

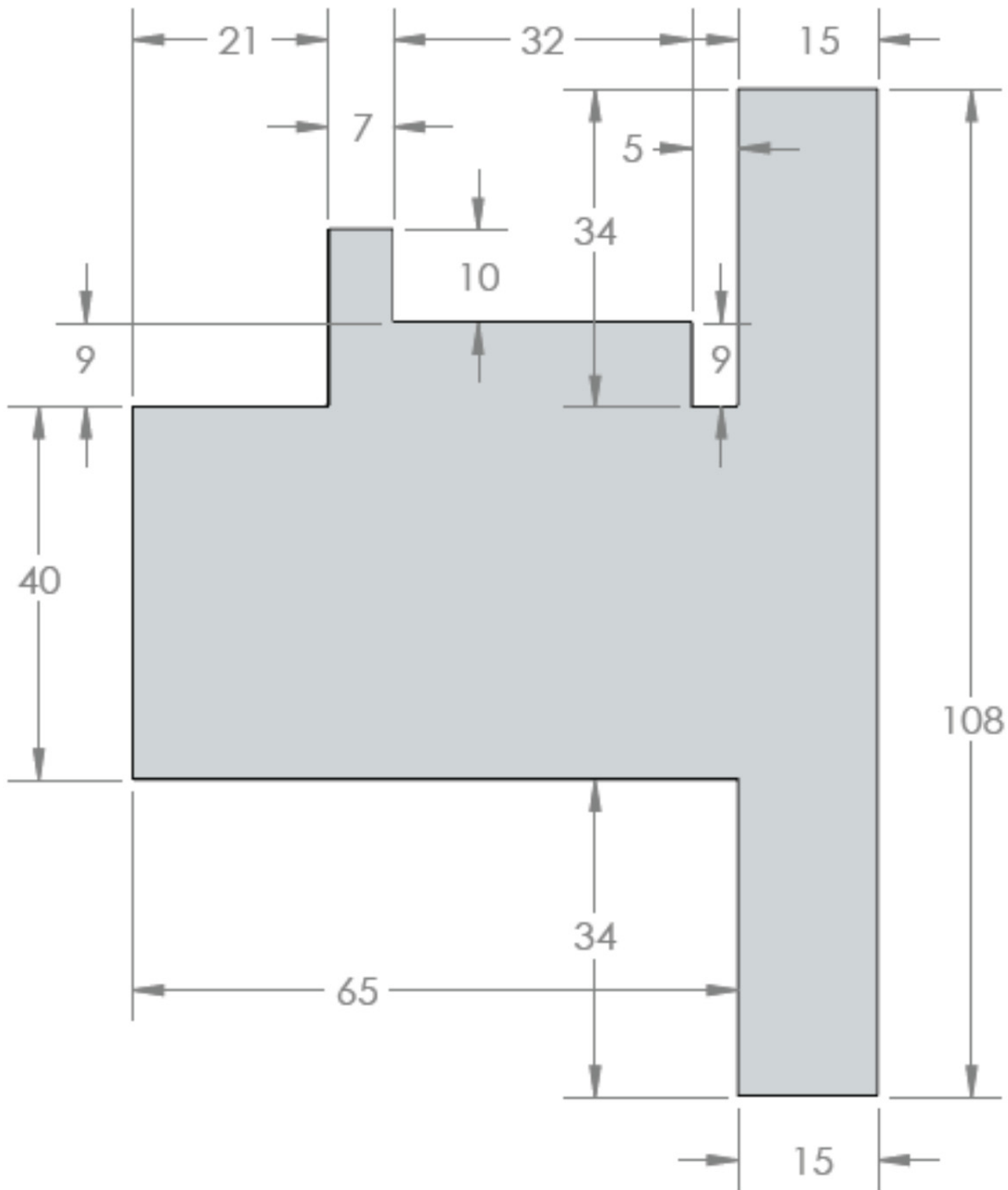


Figure 10 – Heat Spreader Aluminum Dimensions.

### 8.3 Heat Spreader Tape Stencil

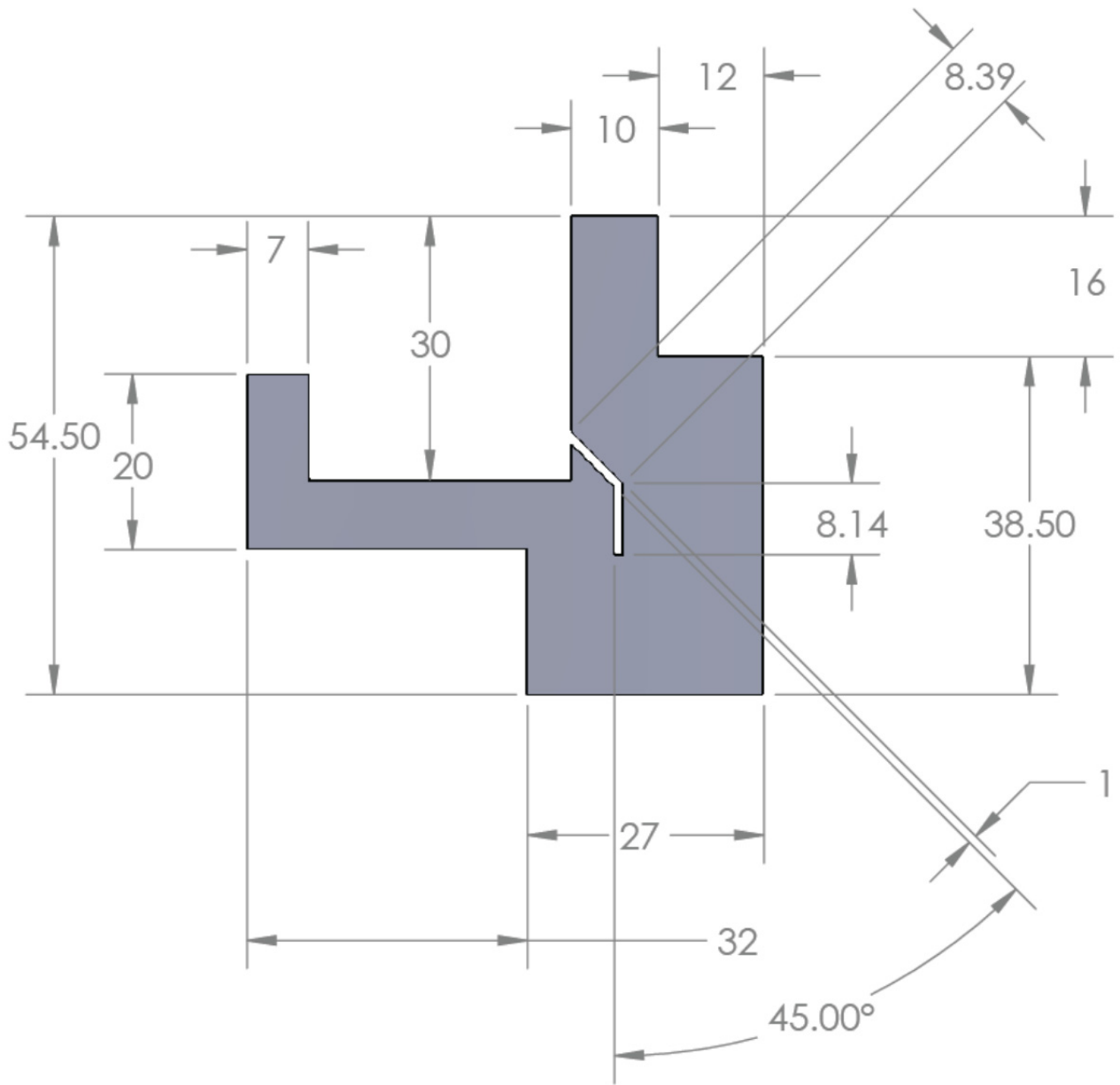
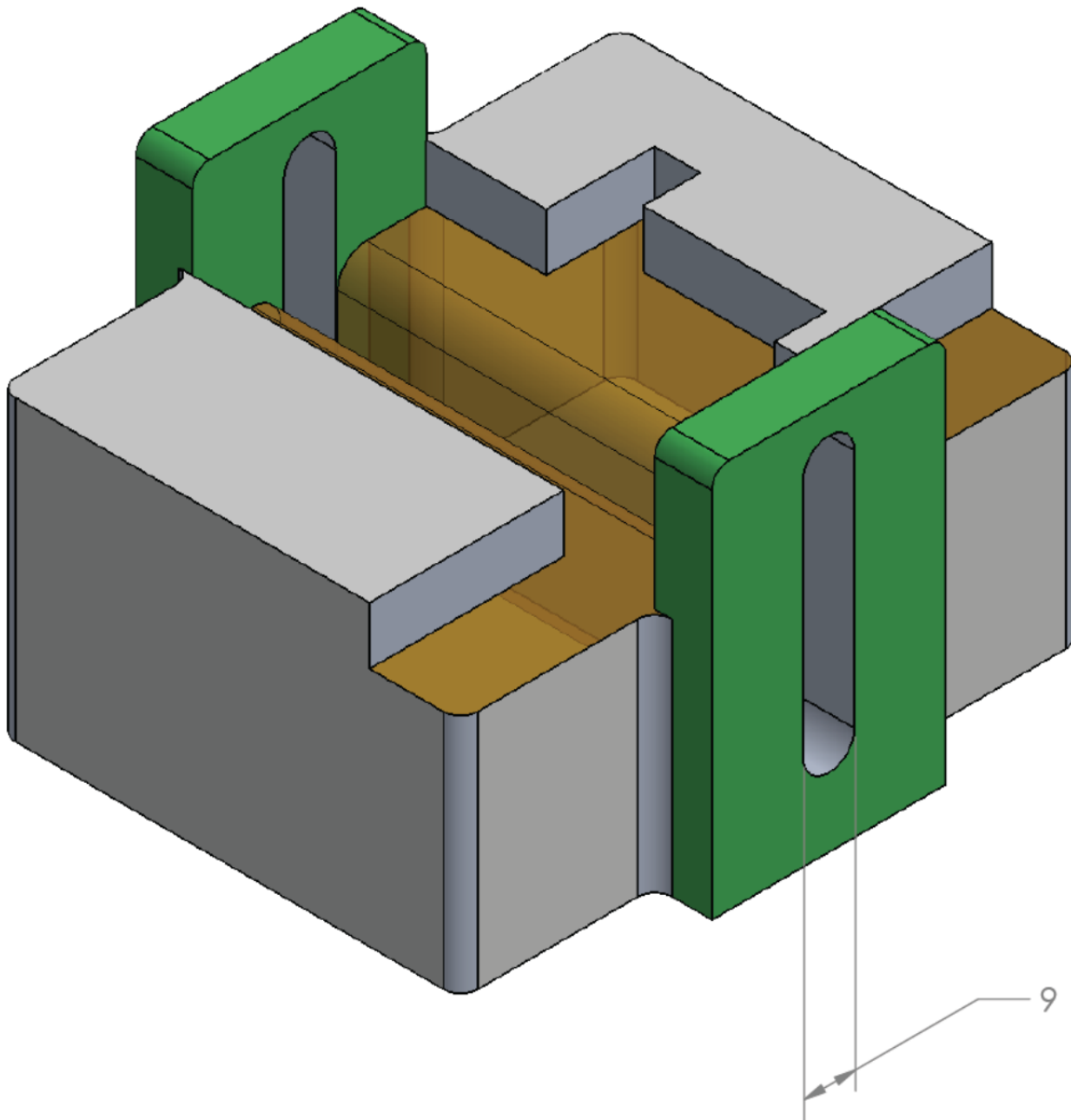


Figure 11 – Heat Spreader Tape Stencil Dimensions.

**8.4 Heat Spreader Bending Tool**



**Figure 12 – Heat Spreader Bending Tool Drawing.**

## 9 Magnetics Specification

### 9.1 Transformer

#### 9.1.1 Electrical Diagram

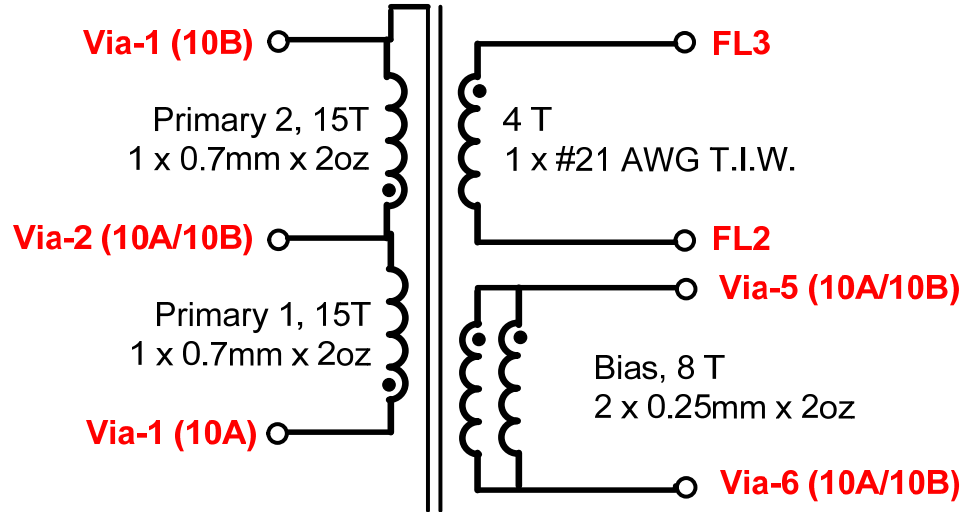


Figure 13 – Transformer Electrical Diagram.

#### 9.1.2 Transformer Cross Sectional Stack-Up View

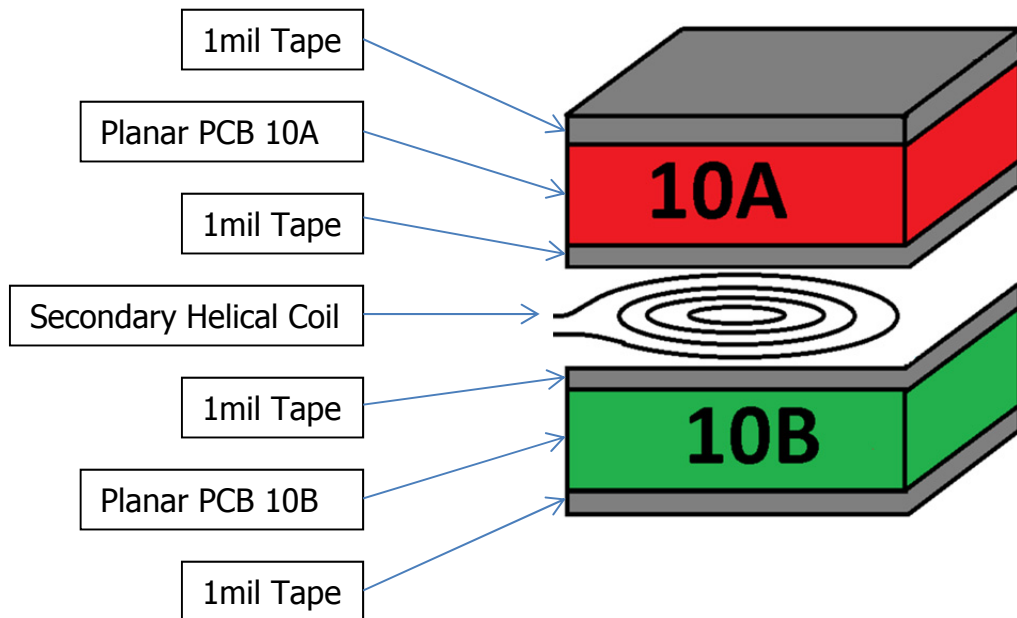


Figure 14 – Transformer Stack-Up View.



9.1.3 Modified Core Details

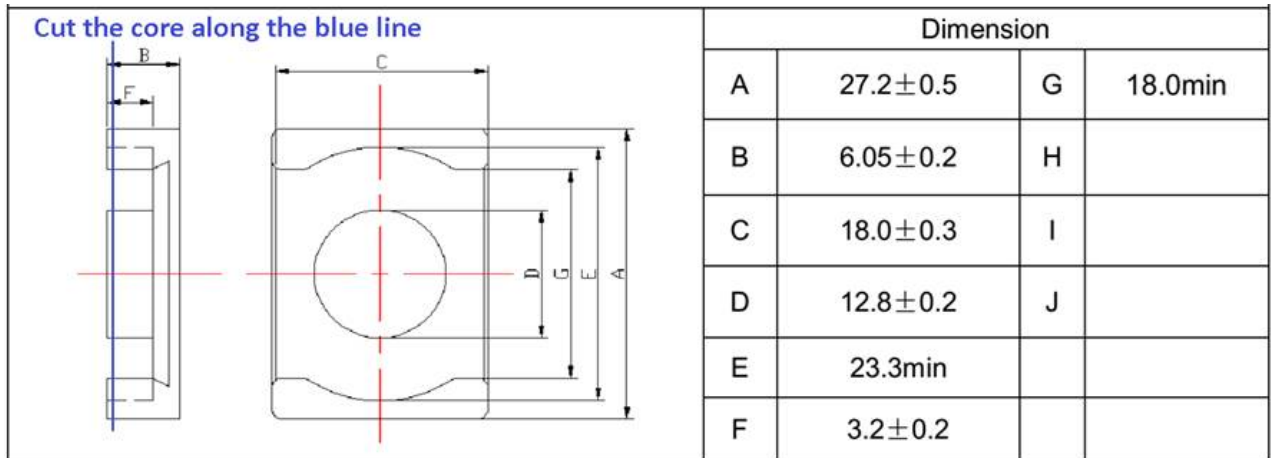
**Product Drawing and Specification**

Customer P/N		Product P/N			
Specification P/N	ACP95-EQ27/6/18	CAS P/N			
		Dimension			
		A	27.2±0.5	G	18.0min
		B	6.05±0.2	H	
		C	18.0±0.3	I	
		D	12.8±0.2	J	
		E	23.3min		
		F	3.2±0.2		

Magnetic dimensions according to IEC205						
Ae(mm <sup>2</sup> )	Amin(mm <sup>2</sup> )	Le(mm)	Ve(mm <sup>3</sup> )	Weight(g/sets)		
108	100	36.3	3920.4	20.19		
Electrical Specification						
Property	Test conditions					Specification
	Frequency	Induction	Temperature	Turn	Field strength	
AL(nH/N <sup>2</sup> )	20KHz	0.25V	25±3°C	10Ts	——	7700±25%
Bs(mT)	25KHz	——	100°C	5Ts	250A/m	≥340
Pv(W/Set)	100KHz	200mT	25°C	5Ts	——	≤2.431
			100°C			≤2.352
Material :	ACP95	CORE-FAMILY ACP95-EQ27/6/18			1	2014/12/19
Name: James.Zhu		Check :	Approve :	001	A4	

Figure 15 – Original Core.





**Figure 16** – Transformer Core Modifications.

1. The core half was cut as shown by the blue line above
2. The 'B' dimension was changed from 6.05±0.2 to 4.95±0.1

#### 9.1.4 Transformer Parameters

<b>Electrical Strength</b>	1 second, 60 Hz, from pins Via-1 (10B) or Via-1 (10A) to leads FL2-FL3.	3000 VAC
<b>Primary Inductance</b>	Pins Via-1 (10B) - Via-1 (10A), all other open, measured at 100 kHz, 0.4 V <sub>RMS</sub> .	513.4 μH, ±5%
<b>Resonant Frequency</b>	Pins Via-1 (10B) - Via-1 (10A), all other open.	1,100 kHz (Min.)
<b>Primary Leakage</b>	Pins Via-1 (10B) - Via-1 (10A), with FL2-FL3 shorted, measured 100 kHz, 0.4 V <sub>RMS</sub> .	15 μH (Max.)

9.1.6 Transformer Stack-Up

Material	Layer	Primary	Bias	Shield			Start	End	Thickness
Ins. Tape	INS1								1mil
Copper	TOP	4.5T					1	9	
FR4									
Copper	L1	4T					9	3	
FR4									
Copper	L2	3T					3	8	
FR4									0.8mm
Copper	L3	3.5T					8	2	
FR4									
Copper	L4		7.5T				5	7	
FR4									
Copper	BOTTOM		0.5T	1T			7	6	
Ins. Tape	INS1								1mil
TIW 1	SEC								1mm
TIW2	SEC								1mm
Ins. Tape	INS1								1mil
Copper	TOP			0.5T			7	6	
FR4									
Copper	L1			7.5T			5	7	
FR4									
Copper	L2	4.5T					2	9	
FR4									0.8mm
Copper	L3	4T					9	3	
FR4									
Copper	L4	3T					3	8	
FR4									
Copper	BOTTOM	3.5T					8	1	
Ins. Tape	INS1								1mil

Table 1 – Transformer Stack-Up Sheet.



9.1.7 Planar PCB Layout

9.1.7.1 Primary Split 1 (10A)

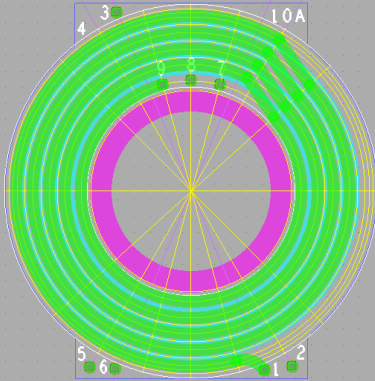
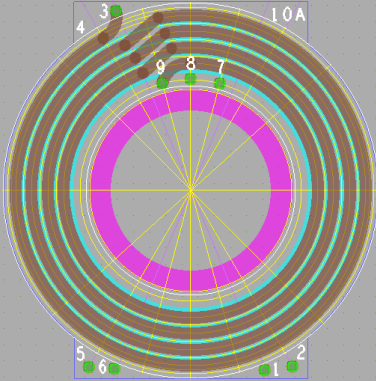
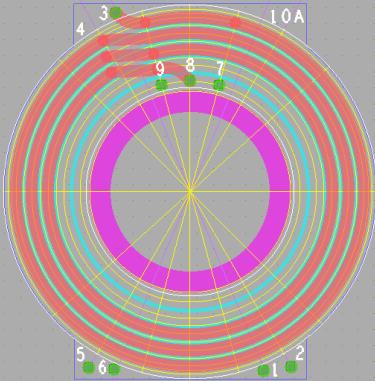
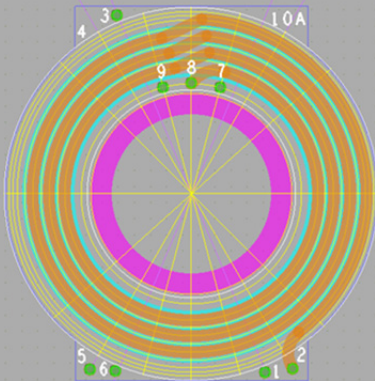
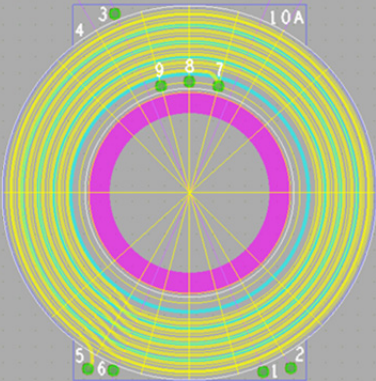
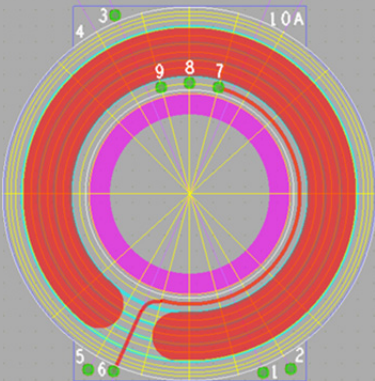
		
<p>PCB: Top; Layer: 1 Winding: Primary (4.5Turns) Start: 1, End: 9 Rotation: Clockwise</p>	<p>PCB: Top; Layer: 2 Winding: Primary (4Turns) Start: 9, End: 3 Rotation: Clockwise</p>	<p>PCB: Top; Layer: 3 Winding: Primary (3Turns) Start: 3, End: 8 Rotation: Clockwise</p>
		
<p>PCB: Top; Layer: 4 Winding: Primary (3.5Turns) Start: 8, End: 2 Rotation: Clockwise</p>	<p>PCB: Top; Layer: 5 Winding: Bias (7.5Turns) Start: 5, End: 7 Rotation: Clockwise</p>	<p>PCB: Top; Layer: 6 Winding: Bias (0.5Turns) Start: 7, End: 6 Rotation: Clockwise</p>

Table 2 – Planar PCB Split 1 (Top).

9.1.7.2 Primary Split 2 (10B)

<p>PCB: Top; Layer: 1 Winding: Bias (0.5Turns) Start: 7, End: 6 Rotation: Clockwise</p>	<p>PCB: Top; Layer: 2 Winding: Bias (7.5Turns) Start: 5, End: 7 Rotation: Clockwise</p>	<p>PCB: Top; Layer: 3 Winding: Primary (4.5Turns) Start: 2, End: 9 Rotation: Clockwise</p>
<p>PCB: Top; Layer: 4 Winding: Primary (4Turns) Start: 9, End: 3 Rotation: Clockwise</p>	<p>PCB: Top; Layer: 5 Winding: Primary (3Turns) Start: 3, End: 8 Rotation: Clockwise</p>	<p>PCB: Top; Layer: 6 Winding: Bias (3.5Turns) Start: 8, End: 1 Rotation: Clockwise</p>

Table 3 – Planar PCB Split 2 (Bottom).

## 9.2 Common Mode Choke

### 9.2.1 34 mH Common Mode Choke

#### 9.2.1.1 Electrical Diagram

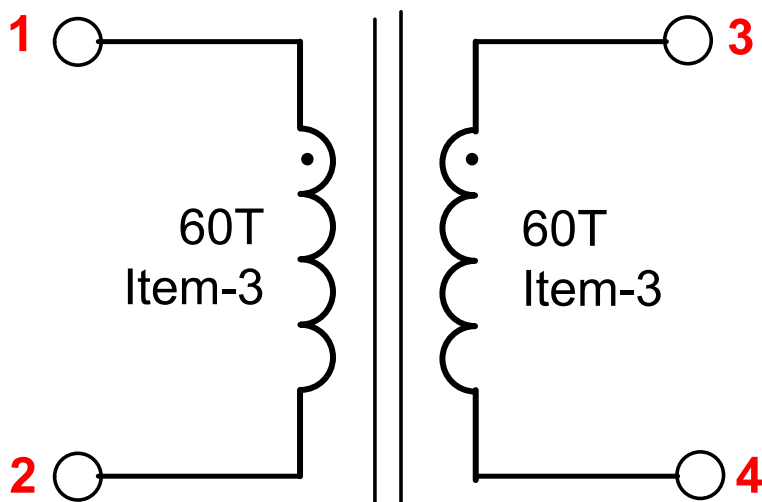


Figure 17 – Electrical Diagram.

#### 9.2.1.2 Electrical Specifications

<b>Winding Inductance</b>	Pin 1 – pin 2 (pin 3 – pin 4), all other windings open, measured at 100 kHz, 0.4 V <sub>RMS</sub> .	30 mH, ±20%
<b>Winding Leakage Inductance</b>	Short pin 2 and pin 4, then measure between pin 1 and pin 3.	>80 μH

#### 9.2.1.3 Material List

Item	Description
[1]	Toroidal Core: Encom T16-10-7C, PI#: 32-00343-00.
[2]	Margin Tape: Polyester Web, 3M 44 or equivalent, 3.2 mm Wide; or Equivalent.
[3]	Magnet Wire: #27 AWG, Double Coated.
[4]	Varnish: Dolph BC-359.



#### 9.2.1.4 Construction

1. Put margin tape Item [2] into the toroid Item [1] to make 2 equal sections.
2. Use  $\sim 4 \frac{1}{2}$  ft of Item [3], start as pin 1 for the 1st section, wind 24 turns for 1st layer, then wind 12 turns for each layer: 2nd, 3rd, and 4th, and end as pin 2. (see illustration below)
3. Do the same for another 2nd section of Toroid but wind symmetrically, start as pin 3 and end at pin 4.
4. Varnish Item [4].
5. Note: all wires should be left  $\sim 1.5''$  floating. Make sure to label each terminal.

#### 9.2.1.5 Illustrations





9.2.2 600  $\mu$ H Common Mode Choke

## 9.2.2.1 Electrical Diagram

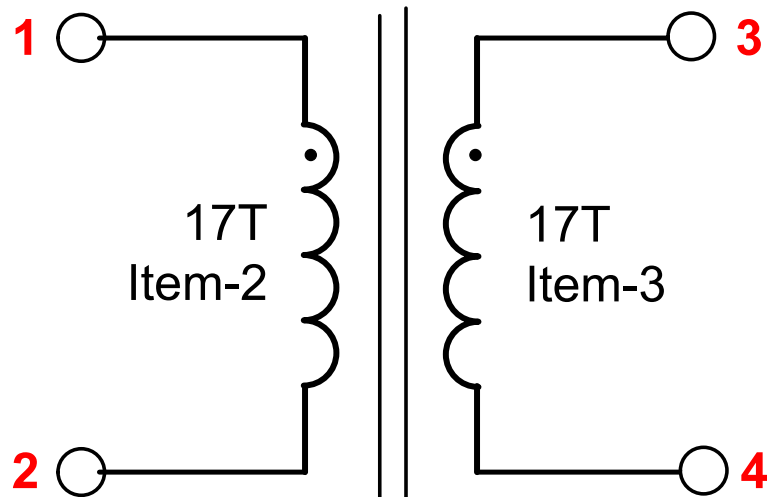


Figure 18 – Choke Electrical Diagram.

## 9.2.2.2 Electrical Specifications

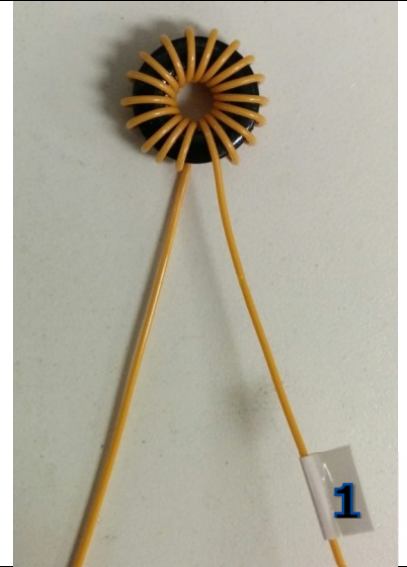
<b>Winding Inductance</b>	Pin 1 – pin 2 (pin 3 – pin 4), all other windings open, measured at 100 kHz, 0.4 V <sub>RMS</sub> .	>600 $\mu$ H
---------------------------	---	--------------

## 9.2.2.3 Material List

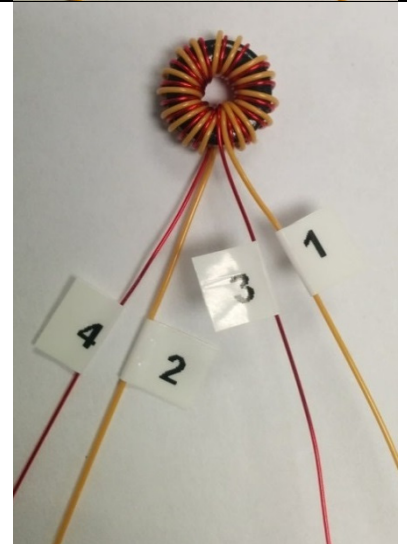
Item	Description
[1]	Toroidal Core: 35T0375-10H, PI#: 32-00275-00.
[2]	Triple Insulated Wire: #28 AWG, Triple Coated.
[3]	Magnet Wire: #28 AWG, Double Coated.
[4]	Varnish: Dolph BC-359.

## 9.2.2.4 Common Mode Choke Construction

Mark the start end of the winding as 1 and wind 17 turns of Item [2] on Item [1]. Mark the end of this winding as 2



Repeat the same procedure as above for the other winding using Item [3], making sure that the start/end and the direction of winding is the same as the first winding.  
Varnish using Item [4]. Mark the start of this winding as 3 and the end as 4.



## 10 Power Supply Assembly Instructions

### 10.1 Input Filter

#### 10.1.1 Schematic

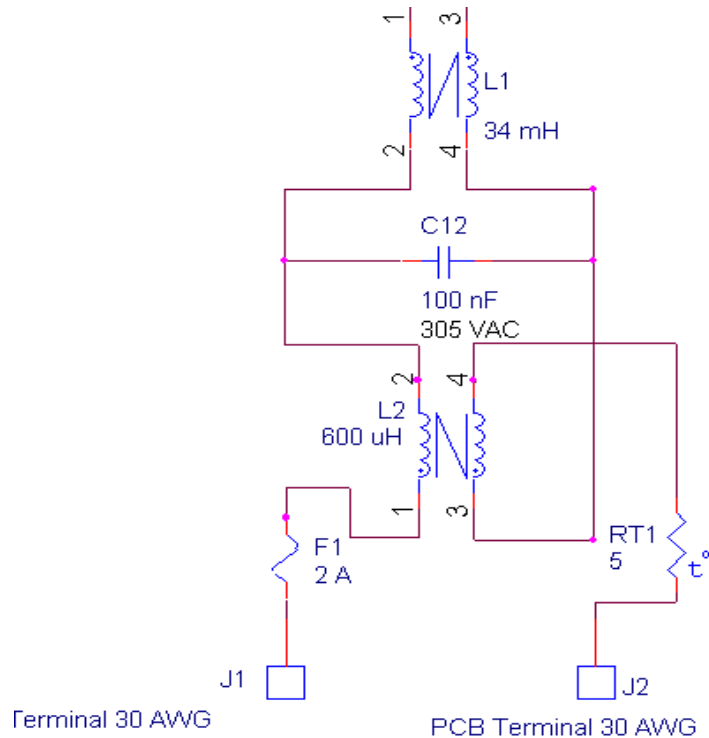
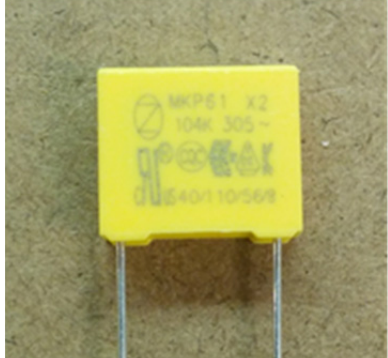
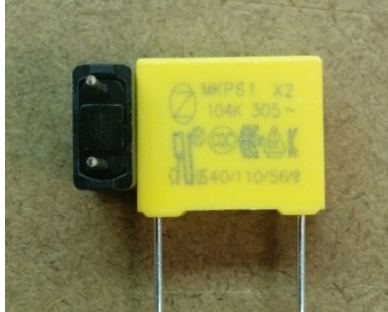

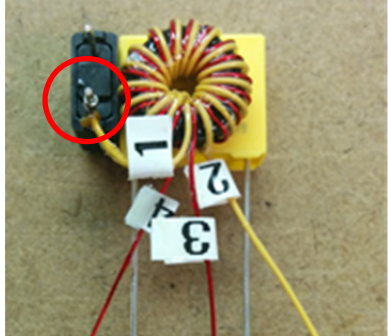


Figure 19 – Input Filter Schematic.

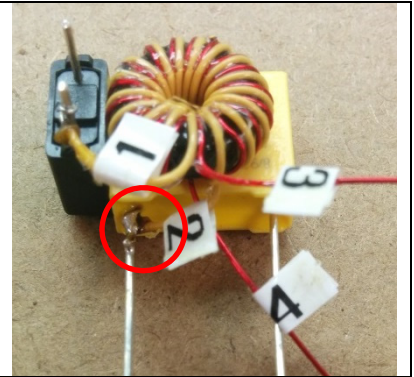
#### 10.1.2 Material List

Item	Description
[1]	X Capacitor: 100 nF, 305 VAC, Polypropylene Film, X2 (PI#20-08957-00).
[2]	Fuse: 2A, 250V, Slow, Long Time Lag, RST (PI#40-00021-00).
[3]	Common Mode Choke: 600uH, Toroidal Common Mode Choke (PI#32-00347-00).
[4]	Common Mode Choke: 34mH, Toroidal Common Mode Choke (PI#32-00345-00).
[5]	Loctite 414.
[6]	Wire: #26 Bus Wire.
[7]	AC Receptacle: (PI#35-00360-00).

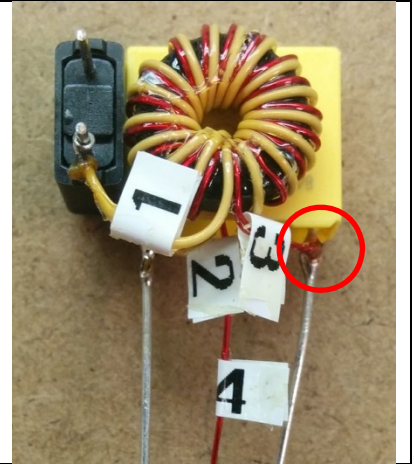
10.1.3 Construction

<p>Take 1 unit of Item [1] and place it on a flat surface.</p>	
<p>Take 1 unit of Item [2] and glue it against the left side of Item [1] as shown using Item [5].</p>	
<p>Glue 1 unit of Item-3 on Item-1 as shown using Item [5].</p>	
<p>Solder terminal-1 of Item-3 to Item [2] as shown.</p>	

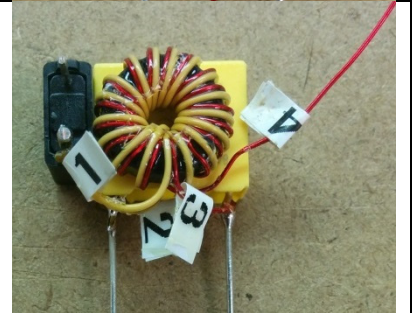
Solder terminal-2 of Item-3 to Item [1] as shown.



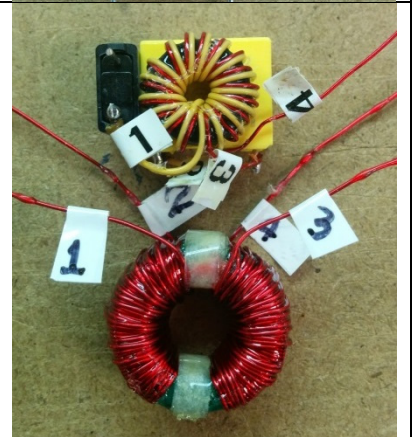
Solder terminal-3 of Item [3] to Item-1 as shown.



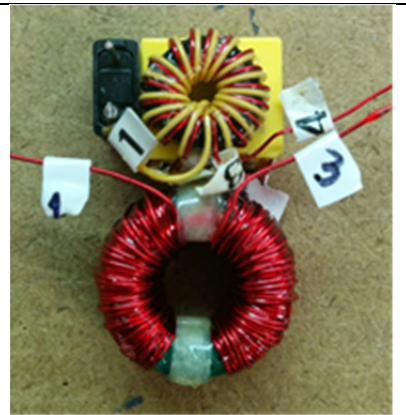
Bend terminal-4 of Item [3] towards the right as shown.



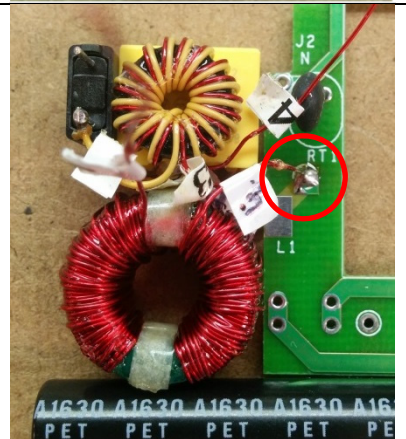
Take 1 unit of Item [4] and place it such that its terminal-1 and terminal-3 are facing upwards and terminal 2 is near terminal-2 of Item [3].



Solder terminal-2 of Item [4] to terminal-2 of Item [3]. Solder terminal-4 of Item [4] to terminal-3 of Item [3] as shown.



Solder terminal-3 of Item [4] to via-3 on the PCB as shown.



Solder terminal-1 of Item [4] to via-1 on the PCB as shown.





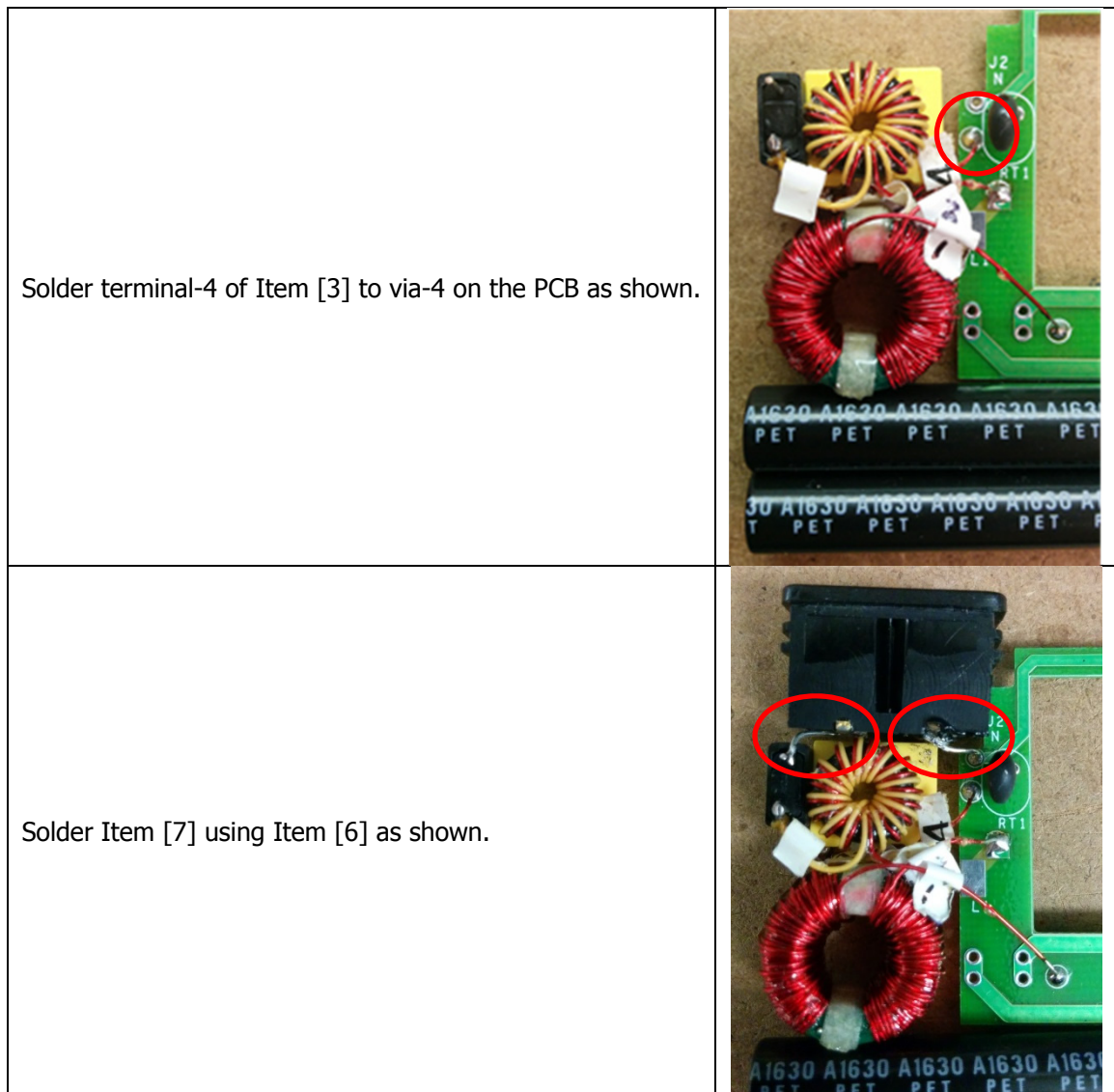


Figure 20 – Input Filter Assembly Instructions.

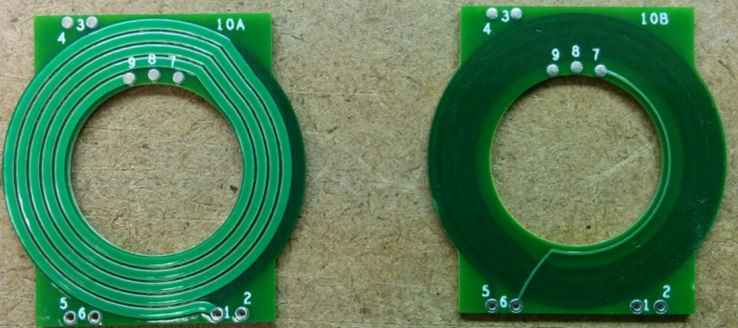
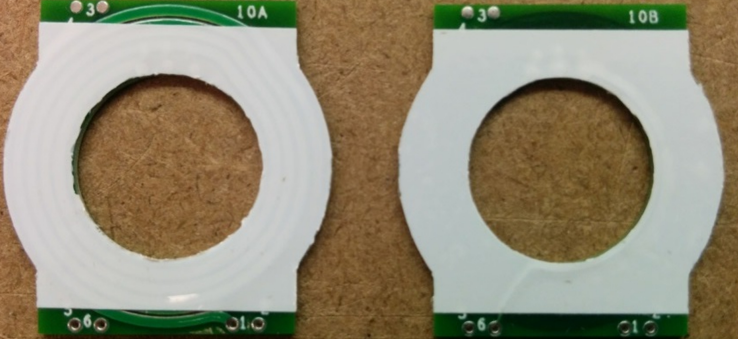
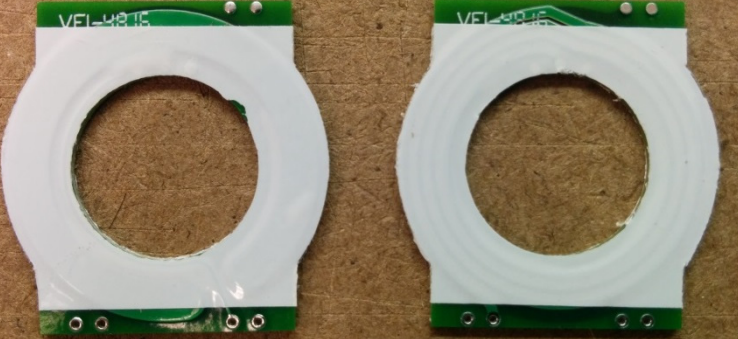
## 10.2 Planar Transformer

### 10.2.1 Material List

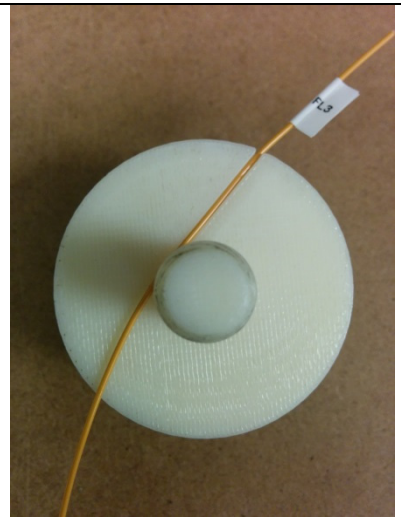
<b>Item 1</b>	Planar Transformer PCB 10A.
<b>Item 2</b>	Planar Transformer PCB 10B.
<b>Item 3</b>	1 mil Insulation (Magnet) Tape. Width = 20 mm.
<b>Item 4</b>	#20 AWG TIW.
<b>Item 5</b>	Secondary Winding Tool.
<b>Item 6</b>	Loctite.
<b>Item 7</b>	Cut and Gapped Cores.
<b>Item 8</b>	1 mil Insulation (Magnet) Tape. Width = 16 mm.
<b>Item 9</b>	#26 AWG Bus Wire.
<b>Item 10</b>	#26 AWG Magnet Wire.
<b>Item 11</b>	2 mil Copper Foil. Width = 9 mm.
<b>Item 12</b>	Varnish: Dolph BC-359.



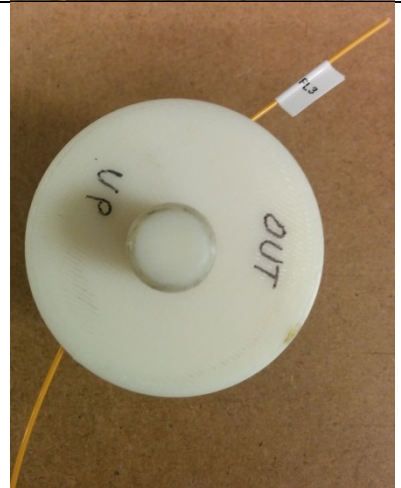
10.2.2 Construction

<p>Take 1 unit of Item-1 and Item-2 and place it on a flat surface</p>	
<p>Apply Item-3 to the top face of Item-1 and Item-2 as shown</p>	
<p>Apply Item-3 to the bottom face of Item-1 and Item-2 as shown</p>	

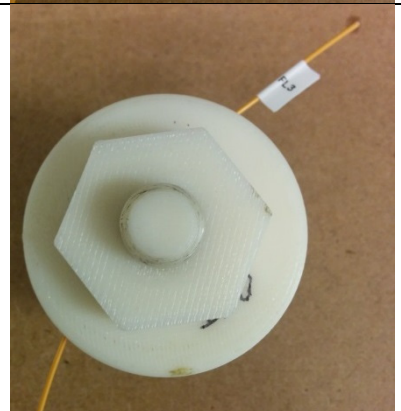
Take 24 inches of Item-4 and label one end as FL3. Then place it on Item-5 as shown



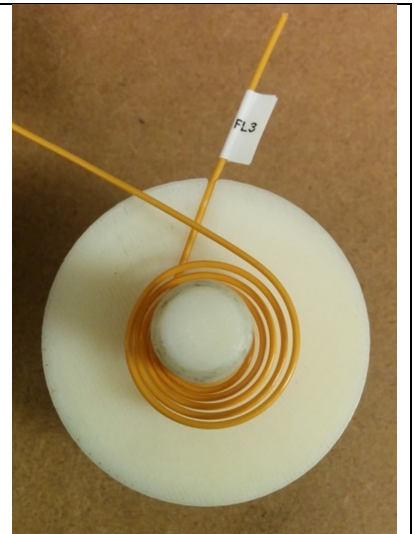
Close Item-5 as shown



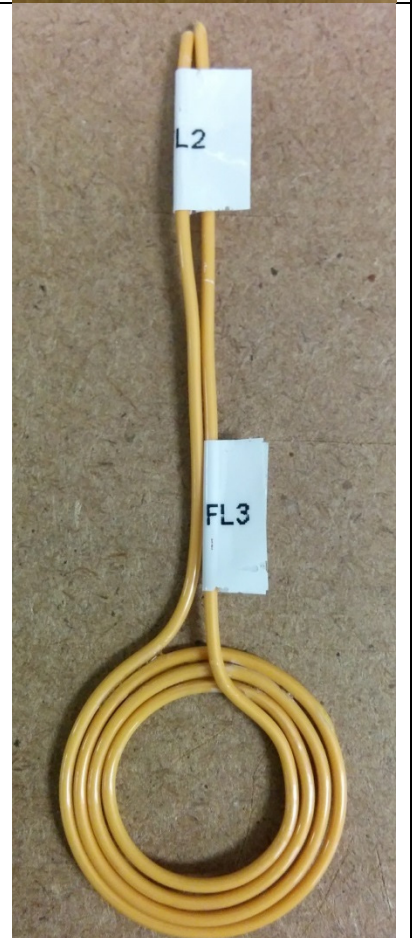
Tighten the nut to a point where the wire no longer slips. Do not over tighten the nut. Wind 4 turns of Item-4 with tension.



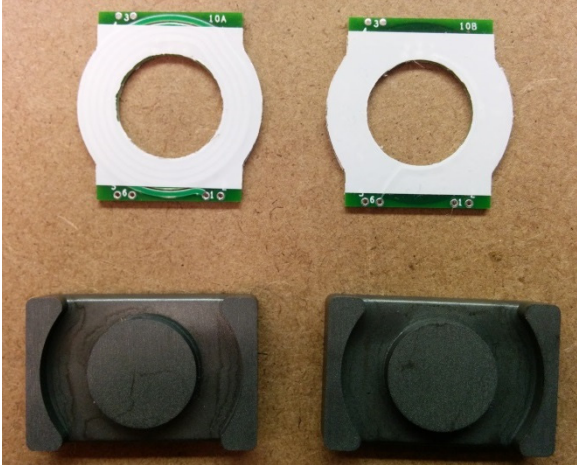
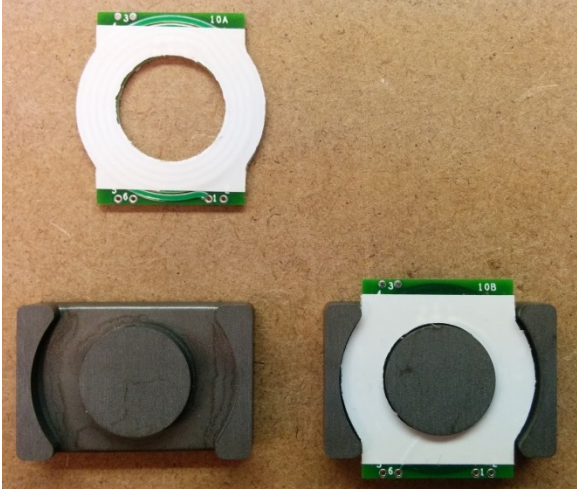
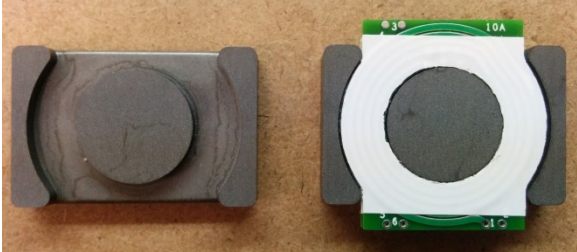

Remove the nut and the upper disc from Item-5. The secondary winding should look as shown



Remove the secondary winding from the tool and bend it such that there are 4 turns from start to end. Apply a small amount of Item-6 to ensure that the winding does not spring open. Let it dry. Label the start and end of the windings as shown.

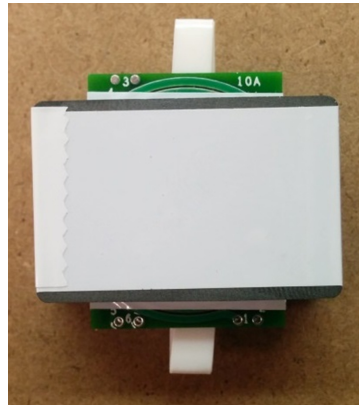




<p>Place 2 units of Item-7 and the taped units of Item-1 and Item-2 on a flat surface as shown</p>	
<p>Place the taped unit of Item-2 inside 1 unit of Item-7 as shown</p>	
<p>Place the taped unit of Item-1 on top of the taped unit of Item-2 as shown</p>	
<p>Place 1 unit of Item-7 on top of the assembly as shown and tape the unit using Item-8</p>	



Place a separator plastic as shown such that the two PCB's are pushed apart

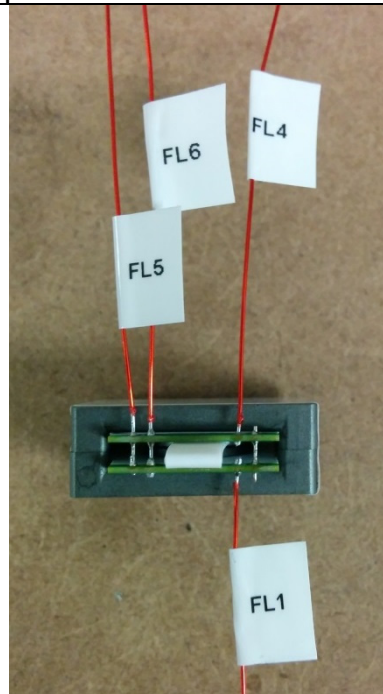


Top View



Side View

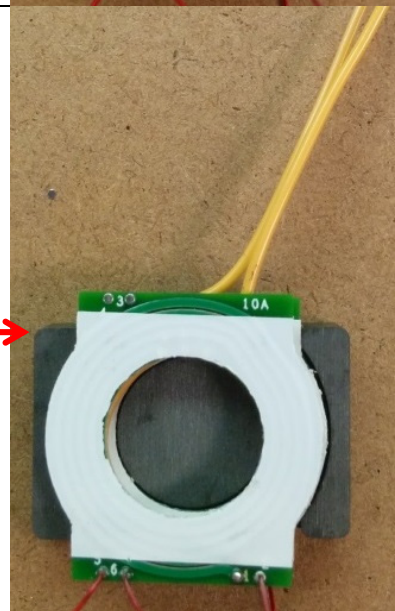
Prepare flying leads using Item-9 and Item-10 as shown. Each flying lead should be approximately 3" long. Label the flying leads as shown



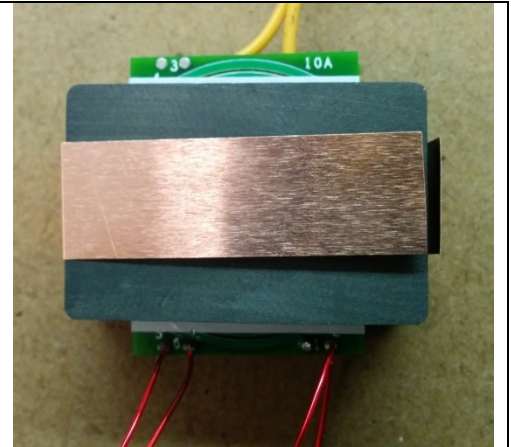
Remove the tape and the top half of Item-7 as shown. Place the secondary winding as shown



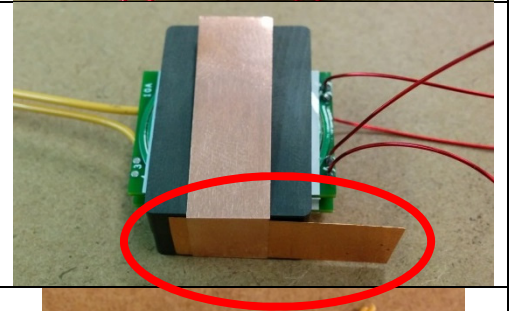
Slide the secondary winding between Item-1 and Item-2 as shown. Rotate the secondary winding towards the right as shown



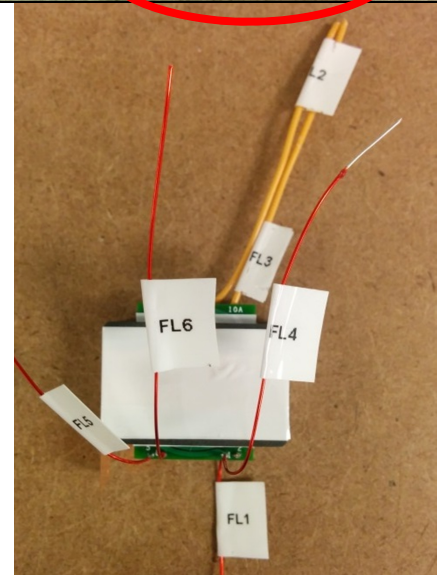
Place the top half of Item-7 and wrap 1 layer of Item-11 as shown



Insert a small strip of Item-11 as shown



Tape tightly 2 layers of Item-8, making sure that the outer legs of the core are touching each other. Varnish the transformer using Item-12



### 10.3 Heat Spreader

#### 10.3.1 Material List

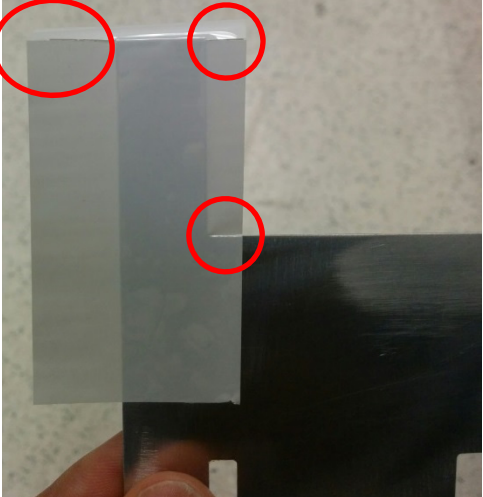


Item	Description
[1]	Aluminum Heat Spreader (16 mil, 3003 material).
[2]	1 mil Insulation (Magnet) Tape. Width = 36 mm.
[3]	Heat Spreader Bending Tool.
[4]	Aluminum Rod. Width = 8 mm.
[5]	Bending Plate.

#### 10.3.2 Construction

Take 1 unit of Item [1] and tape Item [2] as shown .





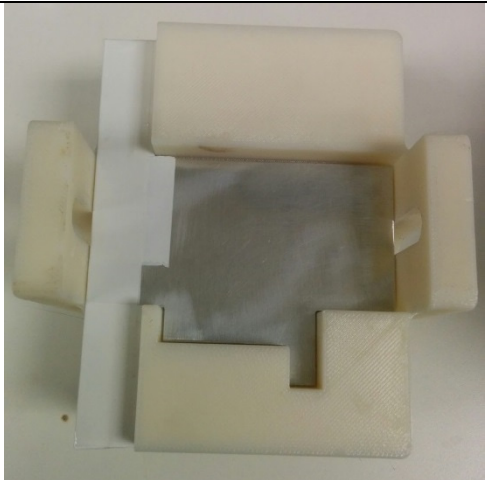
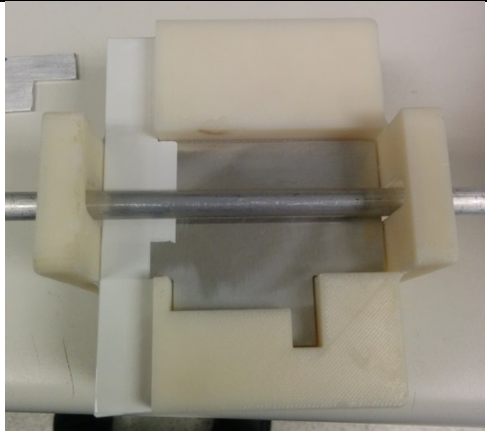
<p>Cut the tape as shown.</p>	
<p>Fold the tape from the sides.</p>	
<p>Fold the tape backwards from the top and cut as shown.</p>	

Fold the tape on the sides and bring the tape to the front from the bottom.

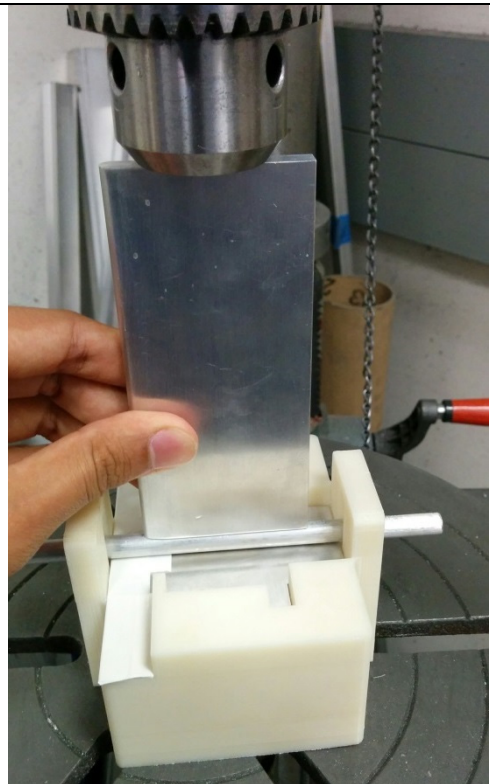


Fold the tape from the sides. Repeat the same process such that there are 2 layers of tape in total.

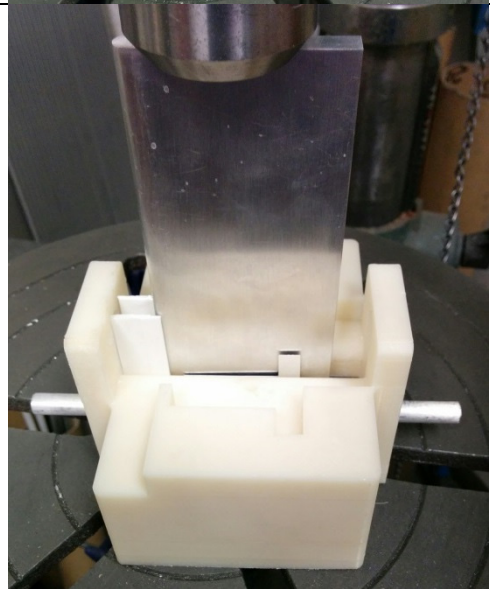


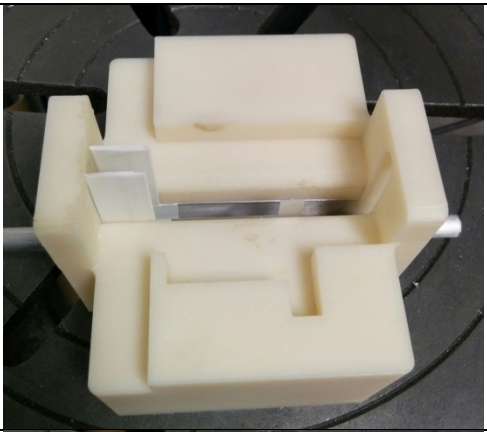
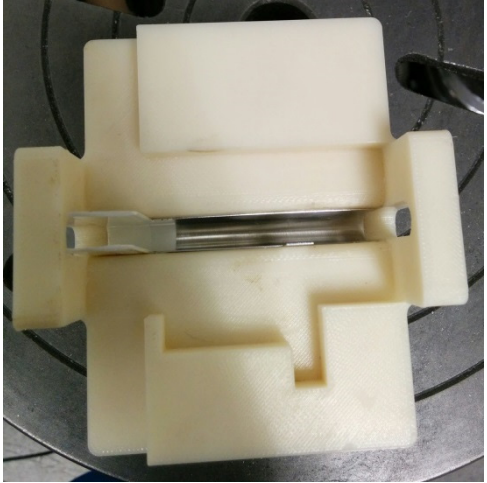
<p>Place 1 unit of Item [1] in Item [3] as shown.</p>	
<p>Place 1 unit of Item [4] as shown.</p>	

Place 1 unit of Item [5] on Item [4] as shown. Place the entire assembly under an arbor/drill press.

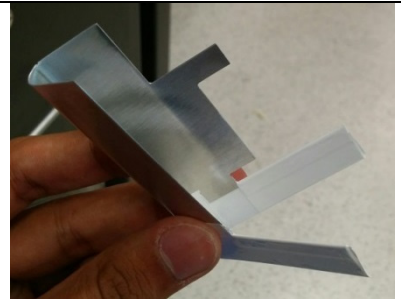


Press down on the bending tool until the Item [1] is bent all the way.



<p>Lift up the press and remove Item [4] and Item [5].</p>	
<p>Item [1] should look as shown.</p>	

Remove Item [1] from Item [3]. Item [1] will tend to spring outwards as shown.



Place Item [3] all the way at the bottom of Item [1] as shown and press Item [1] such that the edges of Item [1] are parallel to each other as shown.





## 10.4 Heat Spreader Tape

### 10.4.1 Material List

Item	Description
[1]	3M Thermal Pad, PI# 66-00231-00.
[2]	Fujipoly Thermal Pad, PI# 66-00232-00.
[3]	Heat Spreader Stencil.
[4]	1 mil Insulation (Magnet) Tape. Width = 10 mm.

### 10.4.2 Construction

Place 1 unit of Item [1] with its darker shade facing upwards (Item [1] is placed on the right for reference).

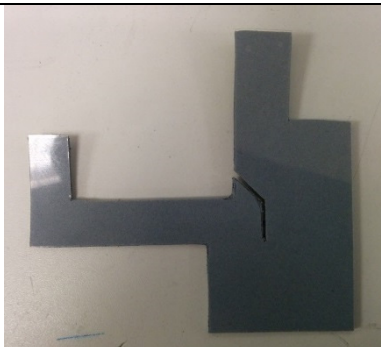
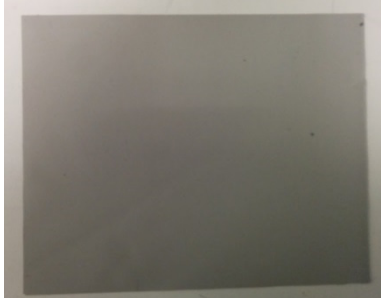
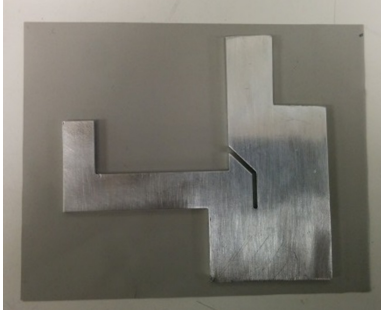
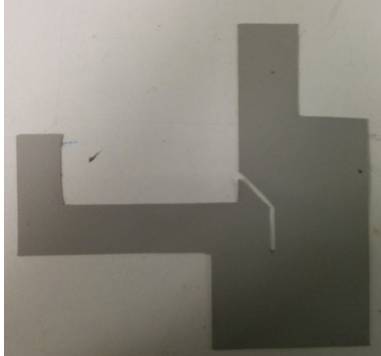


Place 1 unit of Item [3] on top of Item [1].

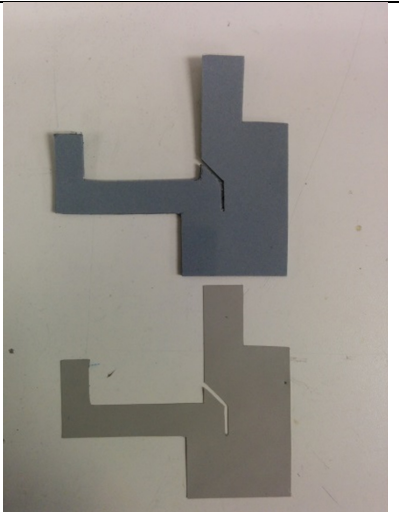
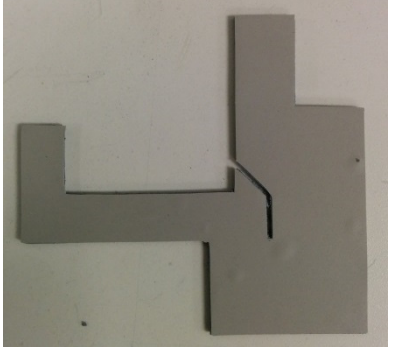
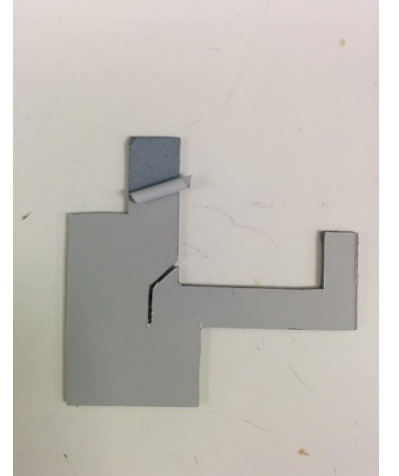


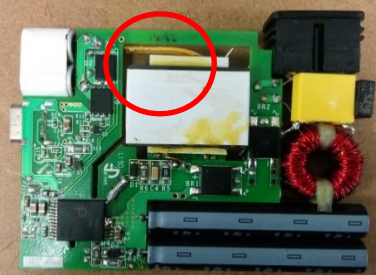

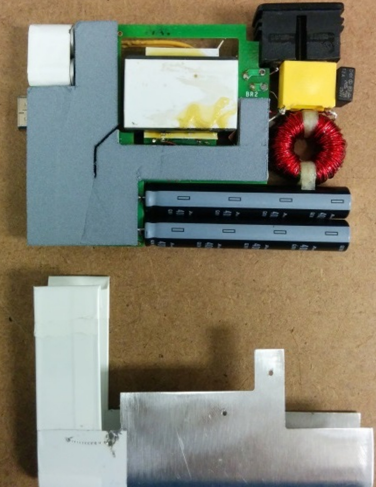
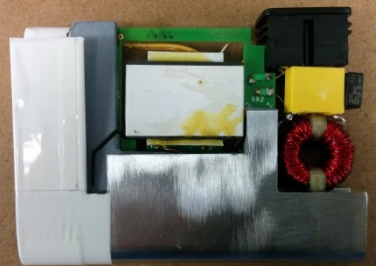
Use a scalpel to cut along the edges of Item [3].



<p>Item [1] should look as shown.</p>	
<p>Place 1 unit of Item [1] on a flat surface.</p>	
<p>Place Item [3] on Item [2] and use a scalpel to cut along the edges of Item [3].</p>	
<p>Item [2] should look as shown.</p>	

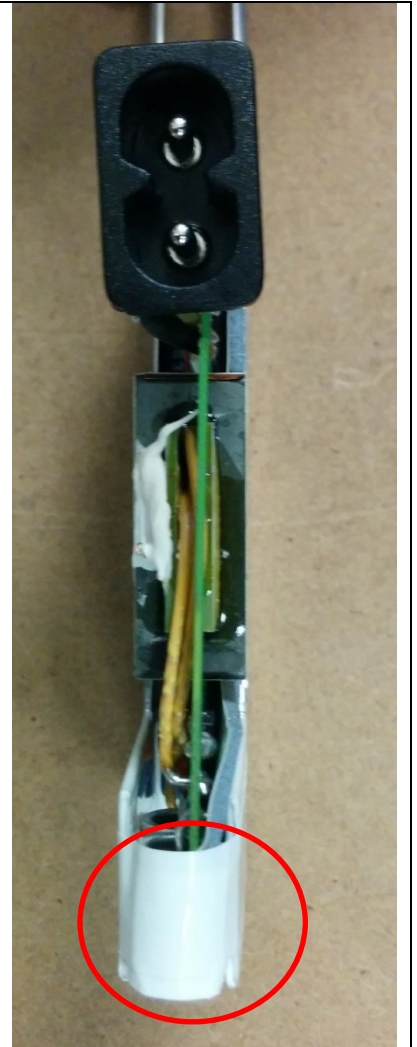


<p>Place the modified Item [1] and Item [2] as shown. Peel off the clear tape from Item [1].</p>	
<p>Place Item [2] on the sticky side of Item [1] as shown.</p>	
<p>Flip the heat spreader assembly created in the previous step and peel off the tape from Item [1].</p>	

<p>Place the PSU as shown. Tape 2 layers of Item [4] to completely cover the output capacitors</p>	
<p>Place the heat spreader as shown</p>	
<p>Take 1 unit of the aluminum heat spreader and slide it over the PSU as shown. Make sure the heat spreader pads do not shift out</p>	
<p>The unit should look as shown</p>	



Take 2" of Item [4] and tape over the two sides of the aluminum heat spreader as shown



## 11 Performance Data

### 11.1 Efficiency

#### 11.1.1 Test Set-up

Parameter	Value
Input Voltage	85 VAC, 115 VAC, 230 VAC, 265 VAC
Output Load	100%, 75%, 50%, 25%, 10%
Enclosure	3D Printed Case
Output Cable	100 mΩ Type-C cable (Google)
Host Board	Cypress PAT Tool (Externally Powered)
Measurement	At the Type-C Receptacle on the Board

#### 11.1.2 Test Data

##### 11.1.2.1 $V_{OUT} = 5 V$

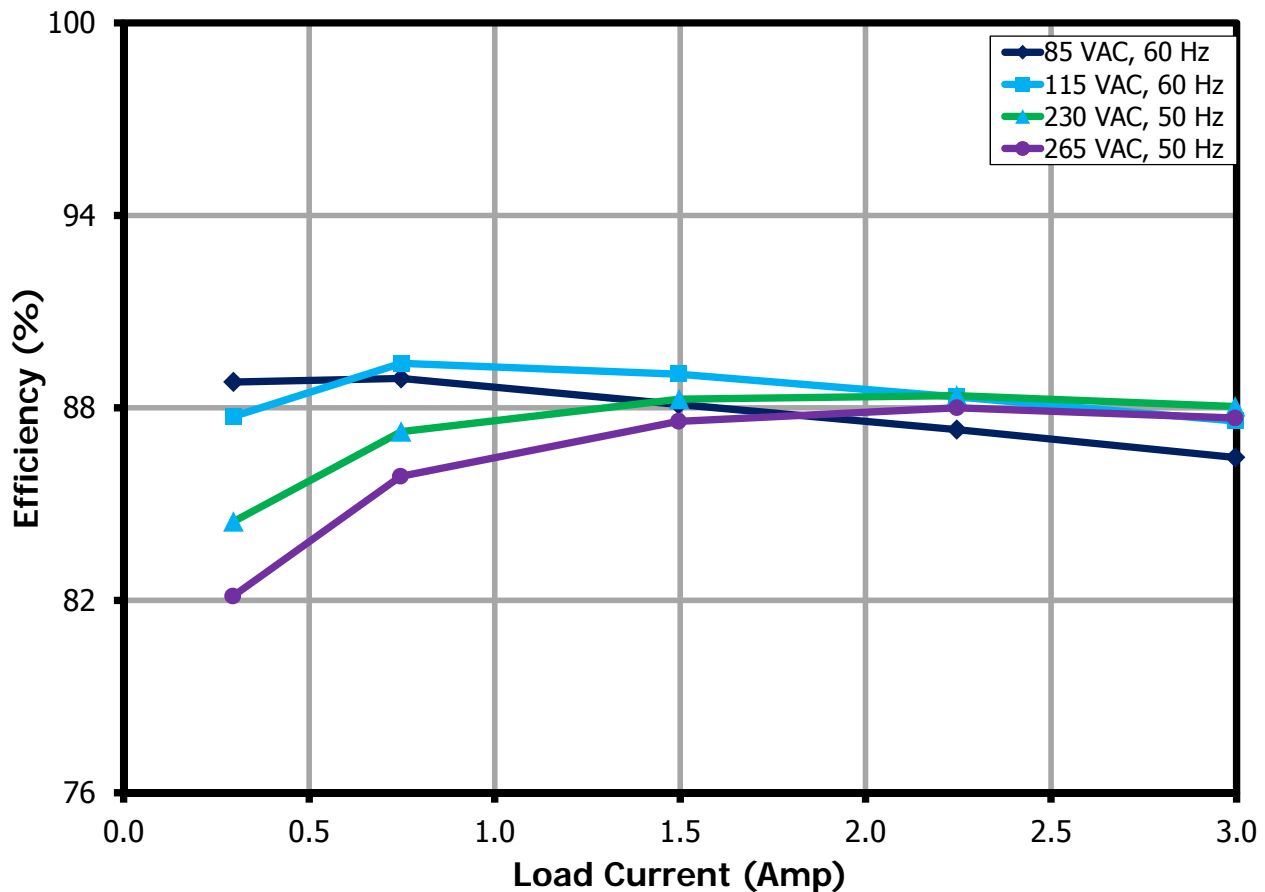


Figure 21 – Load Efficiency,  $V_{OUT} = 5 V$ .

$V_{IN}$	$P_{IN}$ (W)	$V_{OUT}$ (V)	$I_{OUT}$ (A)	$P_{OUT}$ (W)	Efficiency (%)
85 VAC, 60 Hz	17.805	5.138	2.996	15.393	86.45%
	13.306	5.173	2.246	11.619	87.32%
	8.831	5.200	1.496	7.781	88.10%
	4.394	5.223	0.748	3.907	88.92%
	1.748	5.240	0.296	1.552	88.81%
115 VAC, 60 Hz	17.620	5.148	2.998	15.433	87.59%
	13.178	5.183	2.246	11.641	88.34%
	8.754	5.210	1.496	7.795	89.05%
	4.373	5.225	0.748	3.909	89.39%
	1.772	5.248	0.296	1.555	87.73%
230 VAC, 50 Hz	17.560	5.160	2.996	15.461	88.04%
	13.190	5.190	2.246	11.658	88.39%
	8.842	5.210	1.498	7.805	88.27%
	4.484	5.230	0.748	3.913	87.26%
	1.839	5.243	0.296	1.553	84.45%
265 VAC, 50 Hz	17.650	5.165	2.996	15.476	87.68%
	13.260	5.195	2.246	11.669	88.00%
	8.918	5.220	1.496	7.810	87.58%
	4.550	5.235	0.746	3.907	85.86%
	1.880	5.245	0.294	1.544	82.13%

Figure 22 – Load Efficiency Data,  $V_{OUT} = 5$  V.

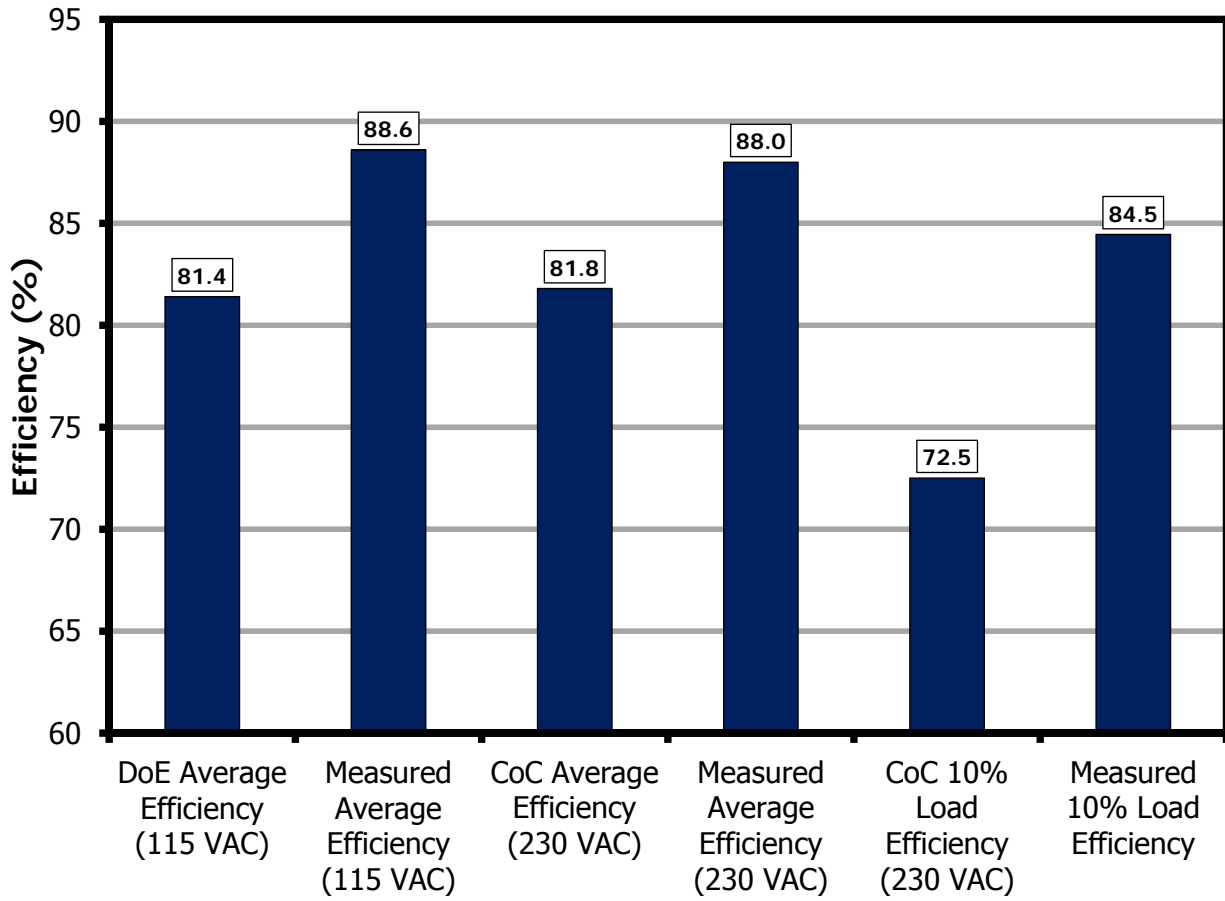


Figure 23 – DoE/CoC Data Comparison,  $V_{OUT} = 5 V$ .

11.1.2.2  $V_{OUT} = 9\text{ V}$

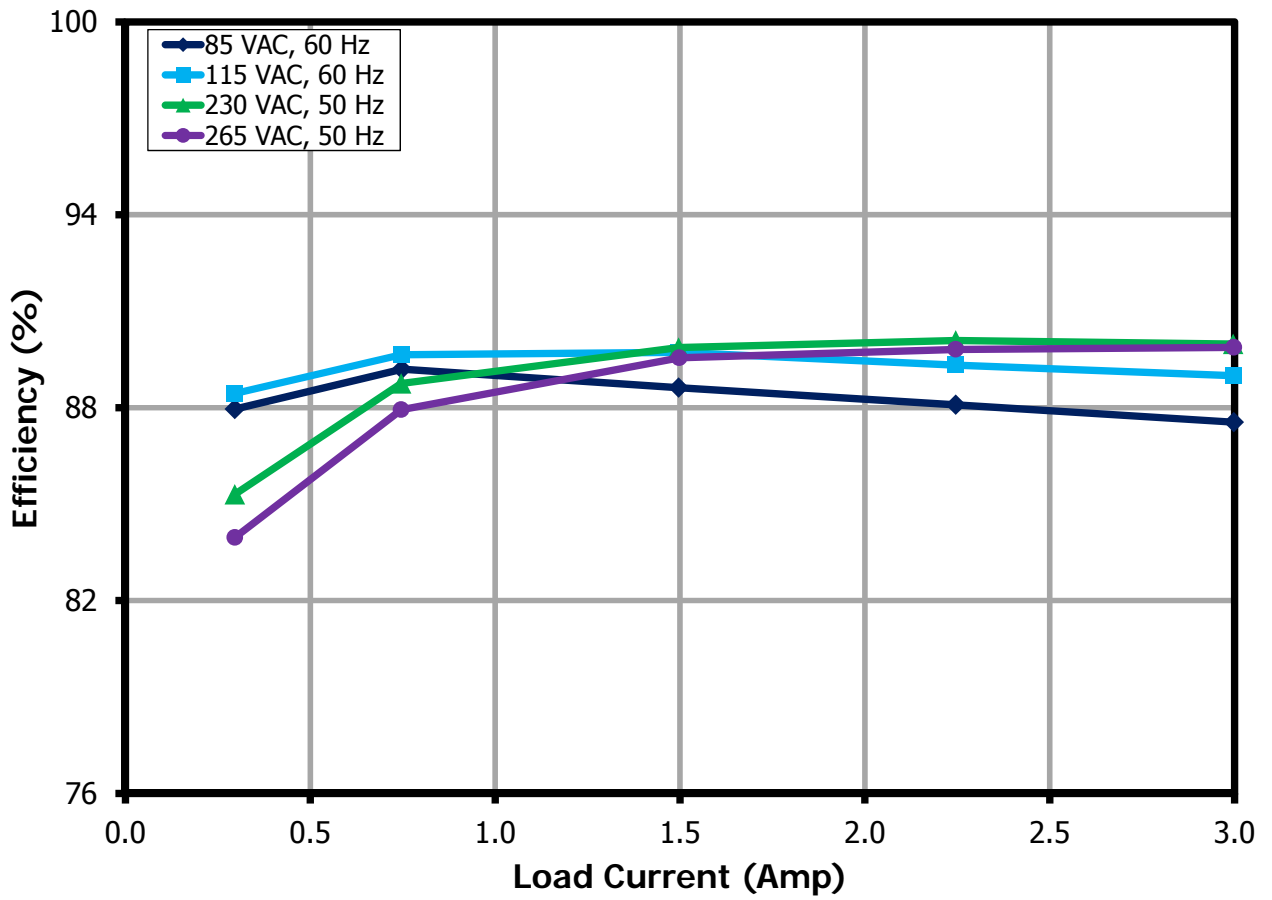


Figure 24 – Load Efficiency,  $V_{OUT} = 9\text{ V}$ .



$V_{IN}$	$P_{IN}$ (W)	$V_{OUT}$ (V)	$I_{OUT}$ (A)	$P_{OUT}$ (W)	Efficiency (%)
85 VAC, 60 Hz	31.180	9.105	2.998	27.298	87.55%
	23.370	9.165	2.246	20.587	88.09%
	15.520	9.193	1.496	13.754	88.62%
	7.729	9.215	0.748	6.894	89.20%
	3.107	9.225	0.296	2.733	87.96%
115 VAC, 60 Hz	30.790	9.140	2.998	27.403	89.00%
	23.080	9.178	2.246	20.615	89.32%
	15.342	9.200	1.496	13.766	89.72%
	7.671	9.215	0.746	6.877	89.65%
	3.090	9.225	0.296	2.733	88.44%
230 VAC, 50 Hz	30.510	9.163	2.996	27.453	89.98%
	22.920	9.193	2.246	20.649	90.09%
	15.330	9.208	1.496	13.777	89.87%
	7.752	9.220	0.746	6.880	88.76%
	3.208	9.238	0.296	2.737	85.31%
265 VAC, 50 Hz	30.590	9.170	2.998	27.493	89.88%
	22.990	9.193	2.246	20.649	89.82%
	15.420	9.218	1.498	13.809	89.55%
	7.824	9.220	0.746	6.880	87.94%
	3.262	9.245	0.296	2.739	83.96%

Figure 25 – Load Efficiency Data,  $V_{OUT} = 9\text{ V}$ .



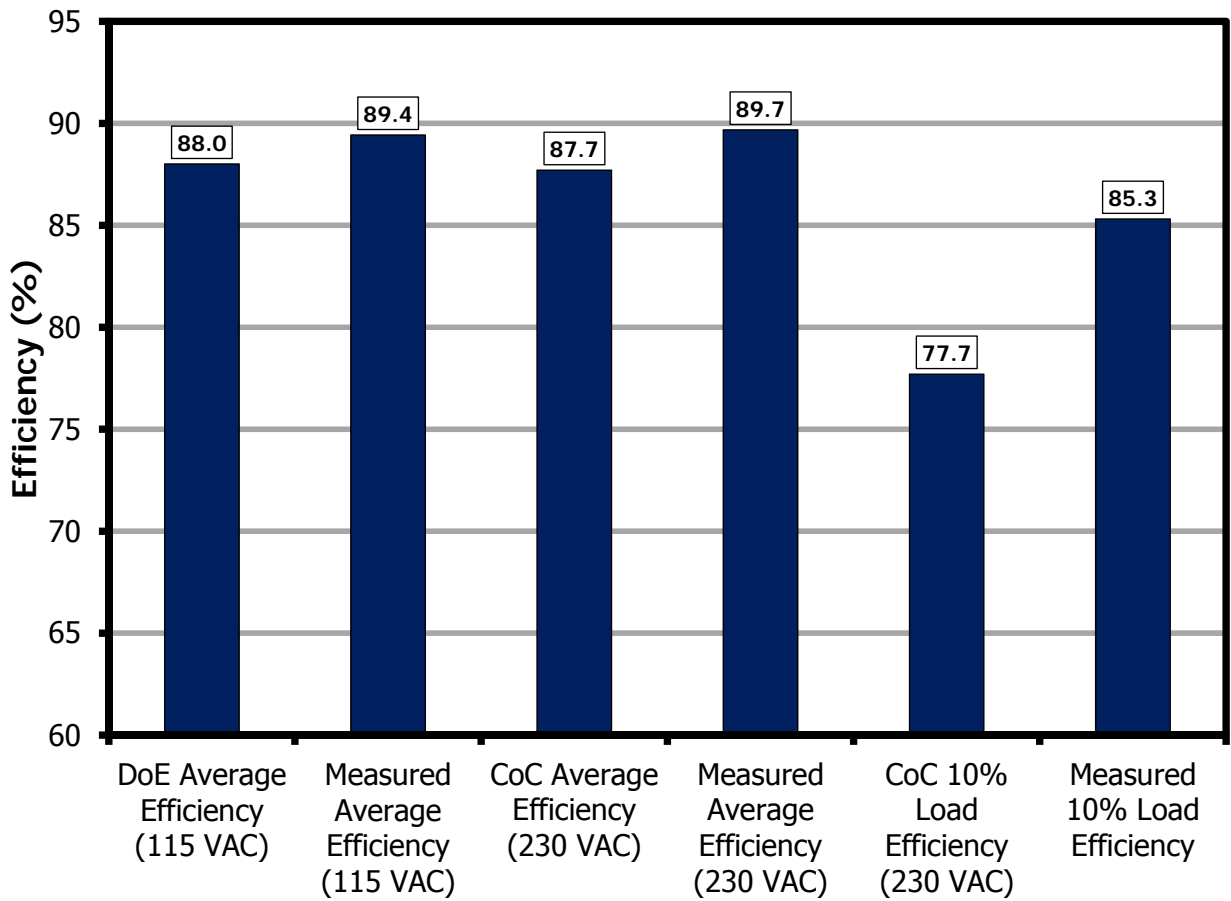


Figure 26 – DoE/CoC Data Comparison,  $V_{OUT}=9$  V.



11.1.2.3  $V_{OUT} = 15\text{ V}$

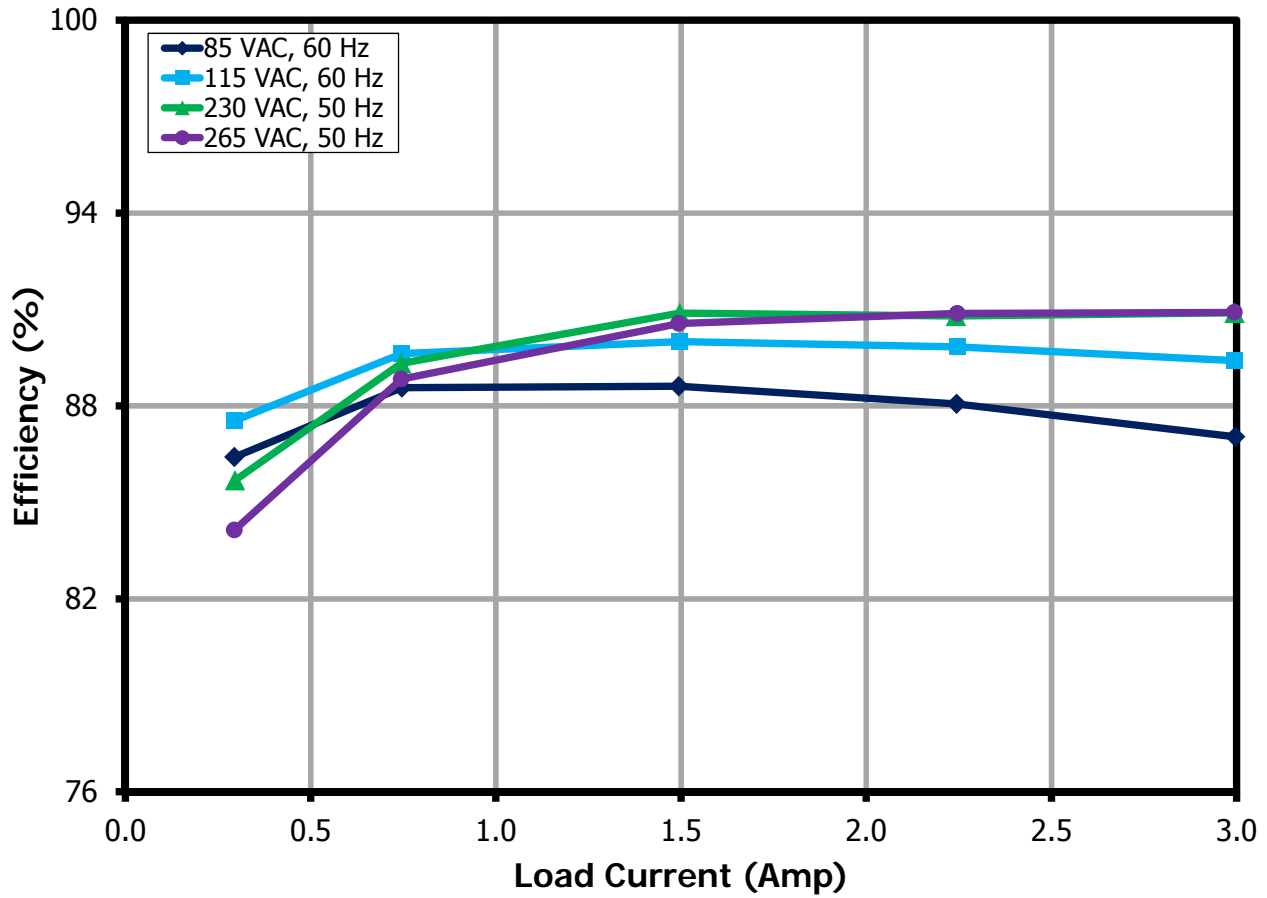


Figure 27 – Load Efficiency,  $V_{OUT} = 15\text{ V}$ .

$V_{IN}$	$P_{IN}$ (W)	$V_{OUT}$ (V)	$I_{OUT}$ (A)	$P_{OUT}$ (W)	Efficiency (%)
85 VAC, 60 Hz	51.850	15.063	2.996	45.131	87.04%
	38.370	15.055	2.244	33.789	88.06%
	25.570	15.163	1.494	22.658	88.61%
	12.792	15.183	0.746	11.330	88.57%
	5.168	15.170	0.294	4.466	86.41%
115 VAC, 60 Hz	50.440	15.060	2.994	45.095	89.40%
	37.830	15.130	2.246	33.986	89.84%
	25.220	15.170	1.496	22.698	90.00%
	12.647	15.190	0.746	11.336	89.63%
	5.134	15.173	0.296	4.495	87.55%
230 VAC, 50 Hz	49.760	15.105	2.994	45.230	90.90%
	37.410	15.148	2.243	33.968	90.80%
	24.990	15.180	1.496	22.713	90.89%
	12.650	15.180	0.744	11.300	89.33%
	5.248	15.180	0.296	4.497	85.69%
265 VAC, 50 Hz	49.820	15.125	2.994	45.290	90.91%
	37.460	15.155	2.246	34.042	90.88%
	25.060	15.188	1.494	22.696	90.57%
	12.720	15.180	0.744	11.300	88.83%
	5.313	15.185	0.294	4.470	84.13%

Figure 28 – Load Efficiency Data,  $V_{OUT} = 15$  V.

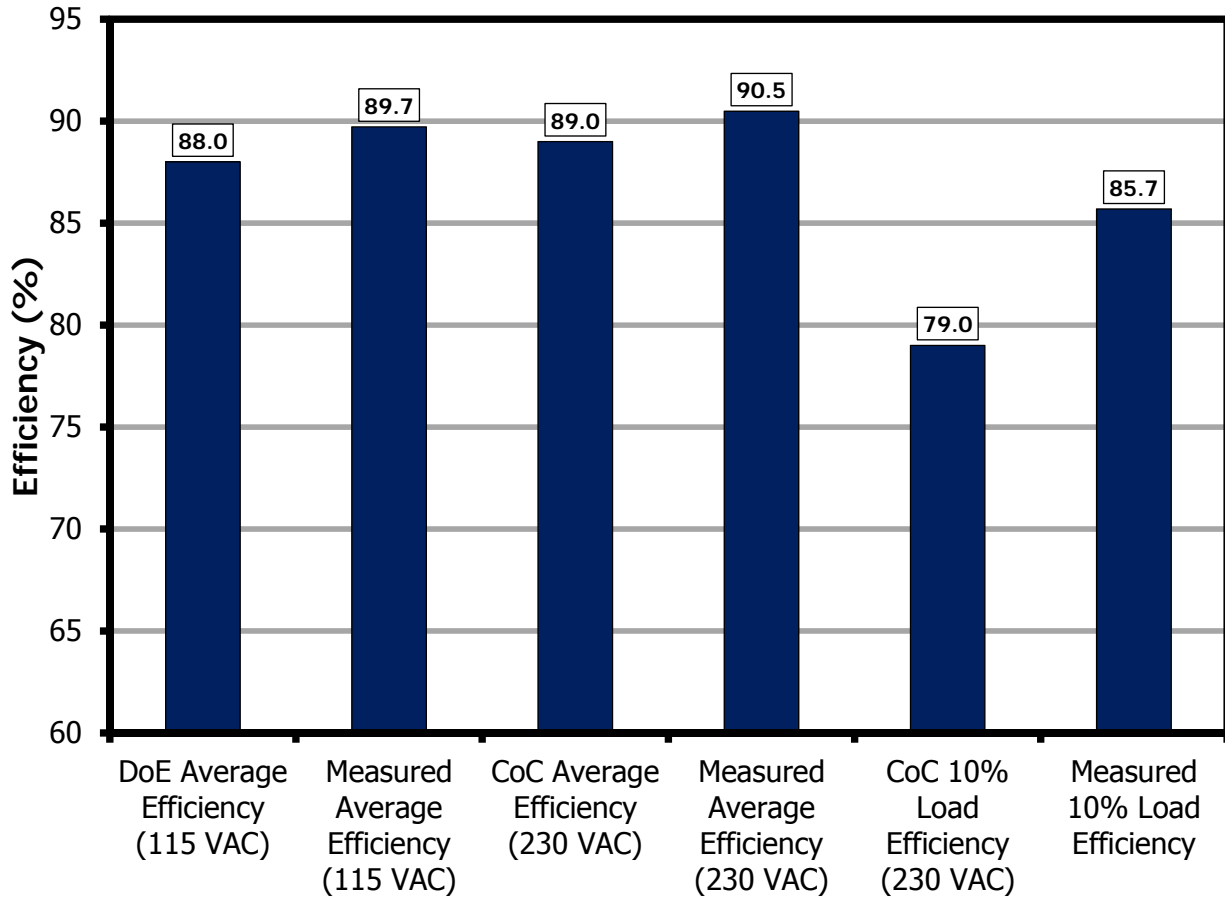


Figure 29 – DoE/CoC Data Comparison,  $V_{OUT} = 15\text{ V}$ .



## 11.2 No-Load Input Power with Type-C Cable Disconnected

### 11.2.1 Test Set-up

Parameter	Value
Input Voltage	85 VAC, 115 VAC, 230 VAC, 265 VAC
Output Load	Disconnected
Enclosure	3D Printed Case
Output Cable	Disconnected
Measurement Time	30 Minutes

### 11.2.2 Test Data

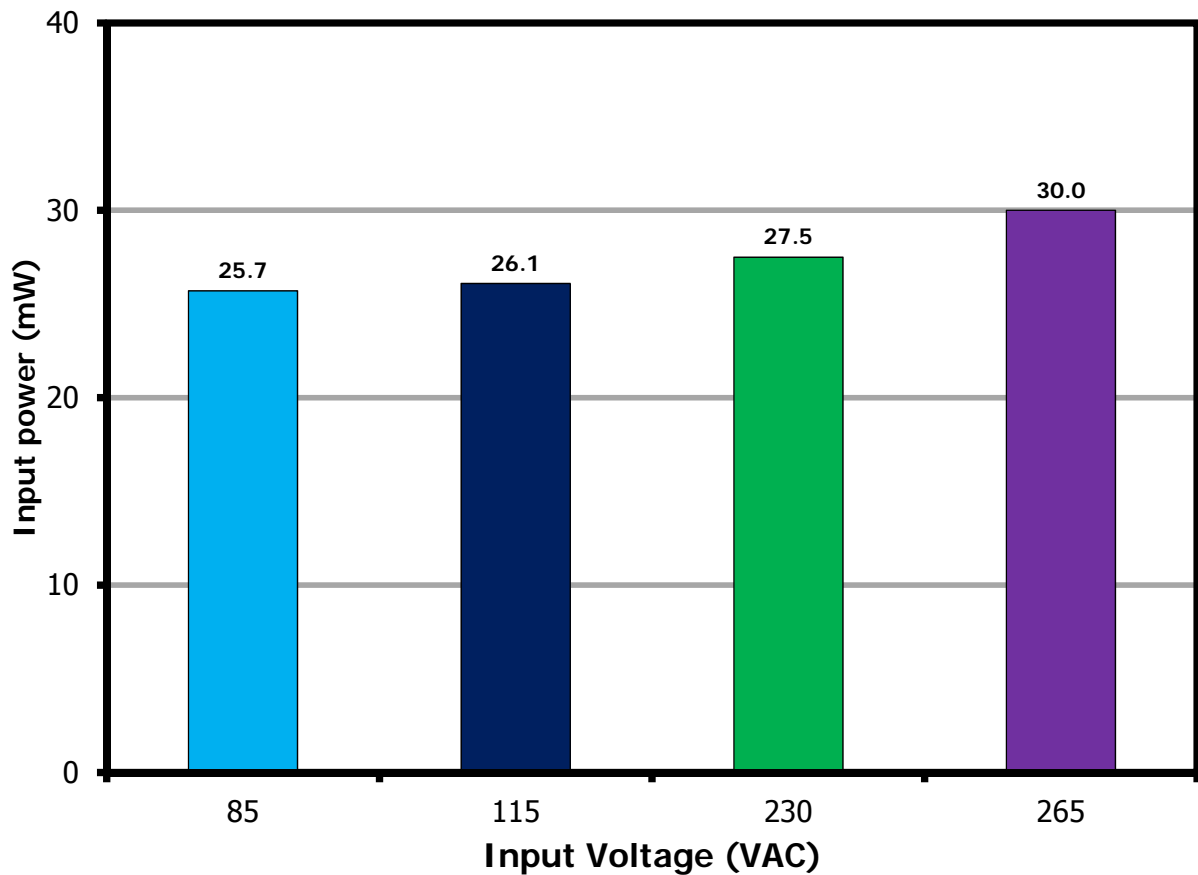


Figure 30 – No-Load Input Power vs. Input Voltage, Room Temperature.

### ***11.3 Load Regulation***

#### 11.3.1 Test Set-up

<b>Parameter</b>	<b>Value</b>
<b>Input Voltage</b>	85 VAC, 115 VAC, 230 VAC, 265 VAC
<b>Output Load</b>	0-3 A
<b>Enclosure</b>	3D Printed Case
<b>Load Connection</b>	At the Type-C Receptacle on the Board

11.3.2 Test Data

11.3.2.1  $V_{OUT} = 5\text{ V}$

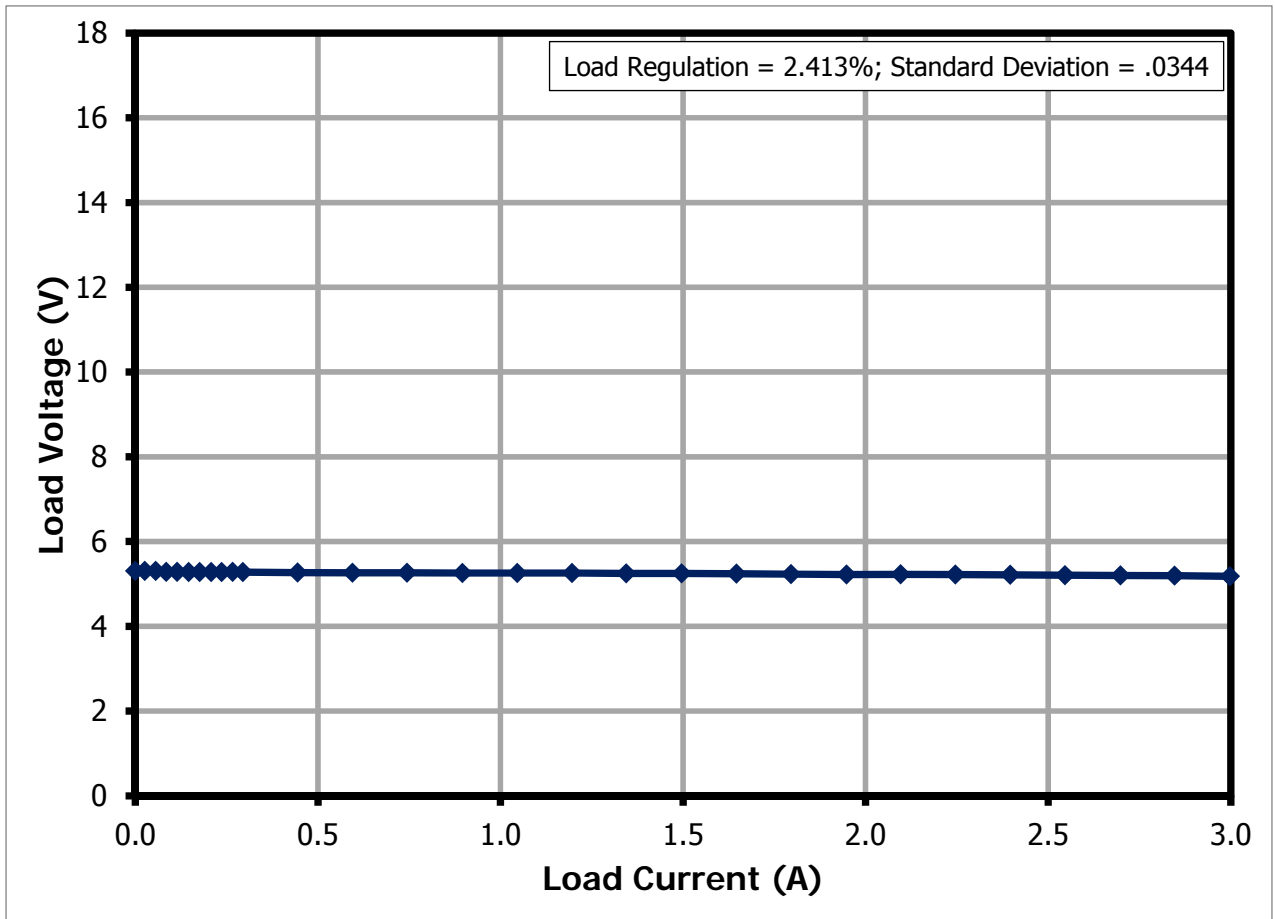


Figure 31 – Load Voltage vs. Load Current, Room Temperature,  $V_{OUT} = 5\text{ V}$ , 85 VAC, 60 Hz.



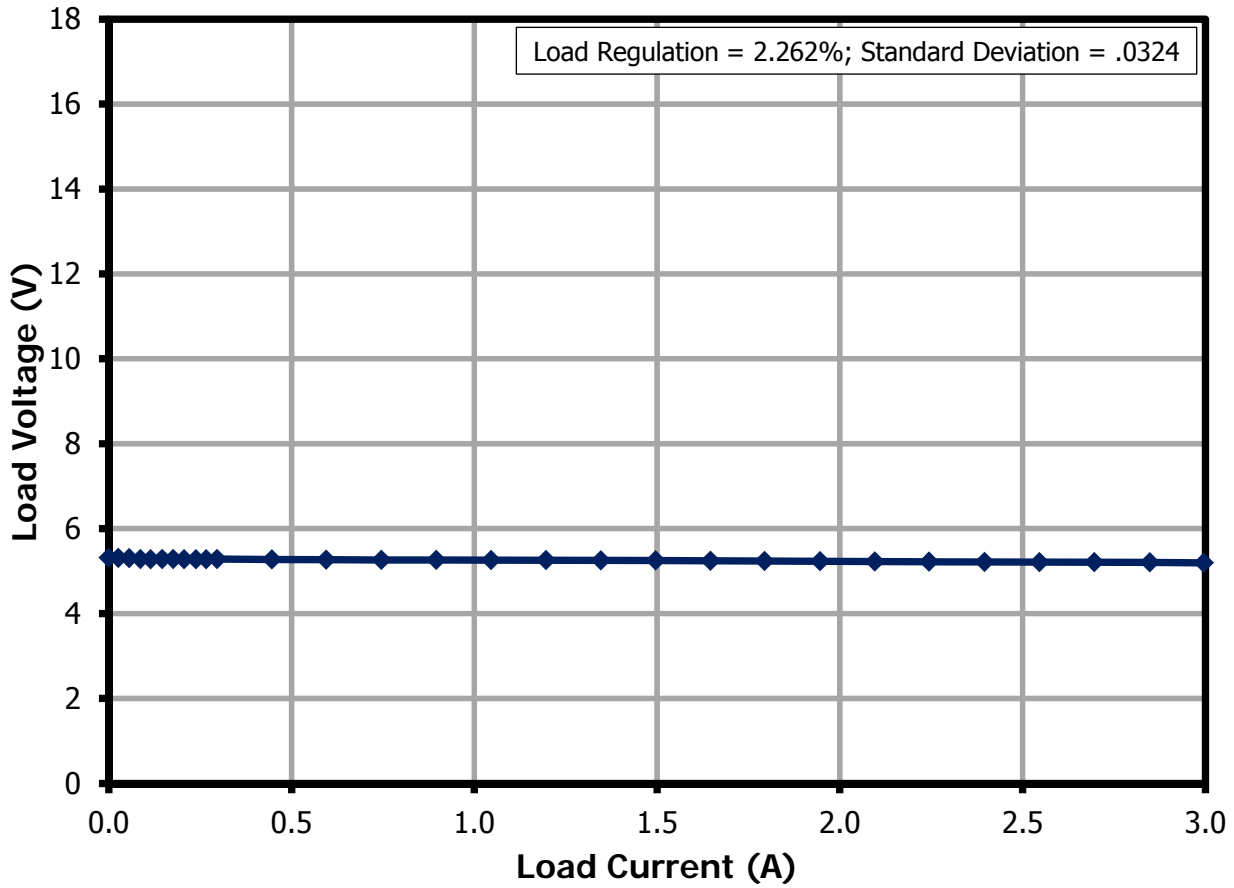


Figure 32 – Load Voltage vs. Load Current, Room Temperature,  $V_{OUT} = 5\text{ V}$ . 115 VAC, 60 Hz.





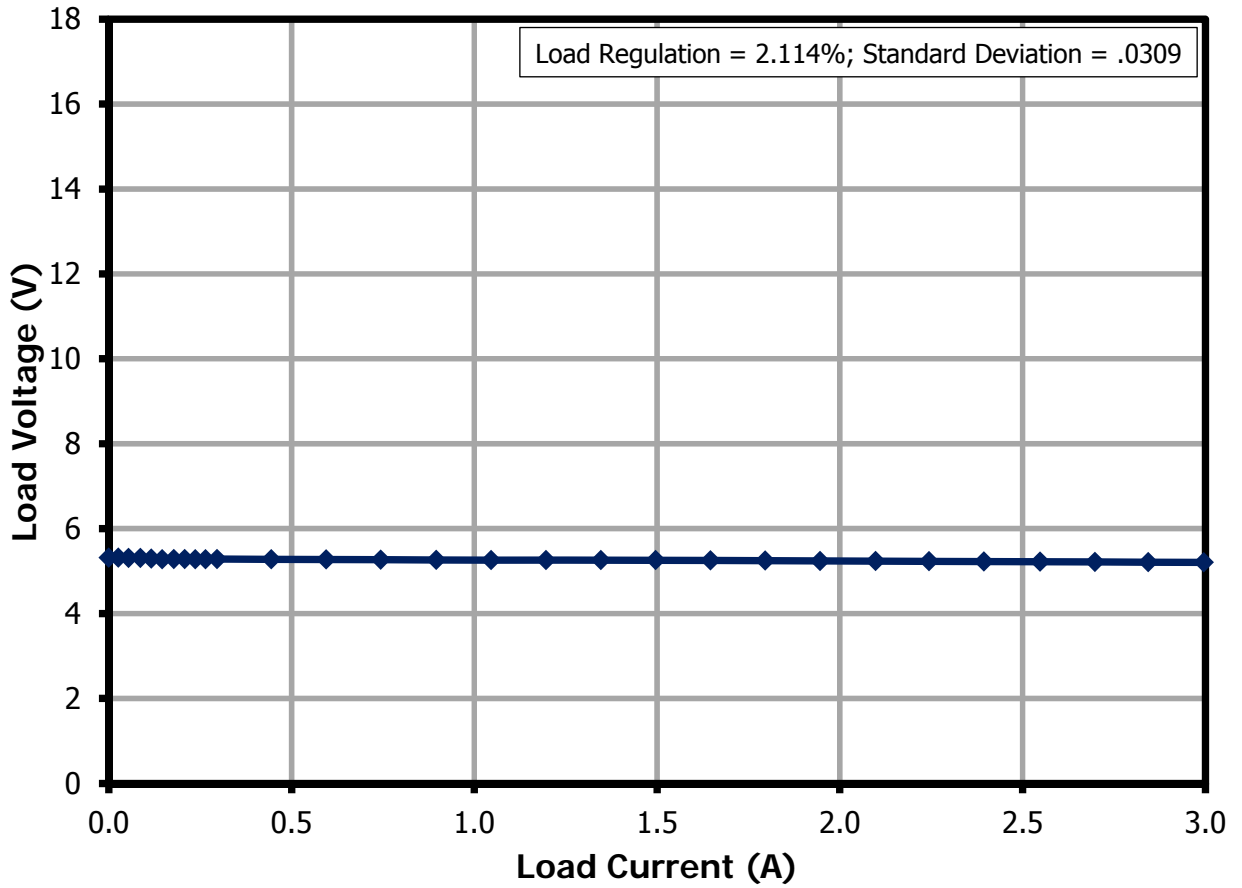


Figure 33 – Load Voltage vs. Load Current, Room Temperature,  $V_{OUT} = 5\text{ V}$ . 230 VAC, 50 Hz.



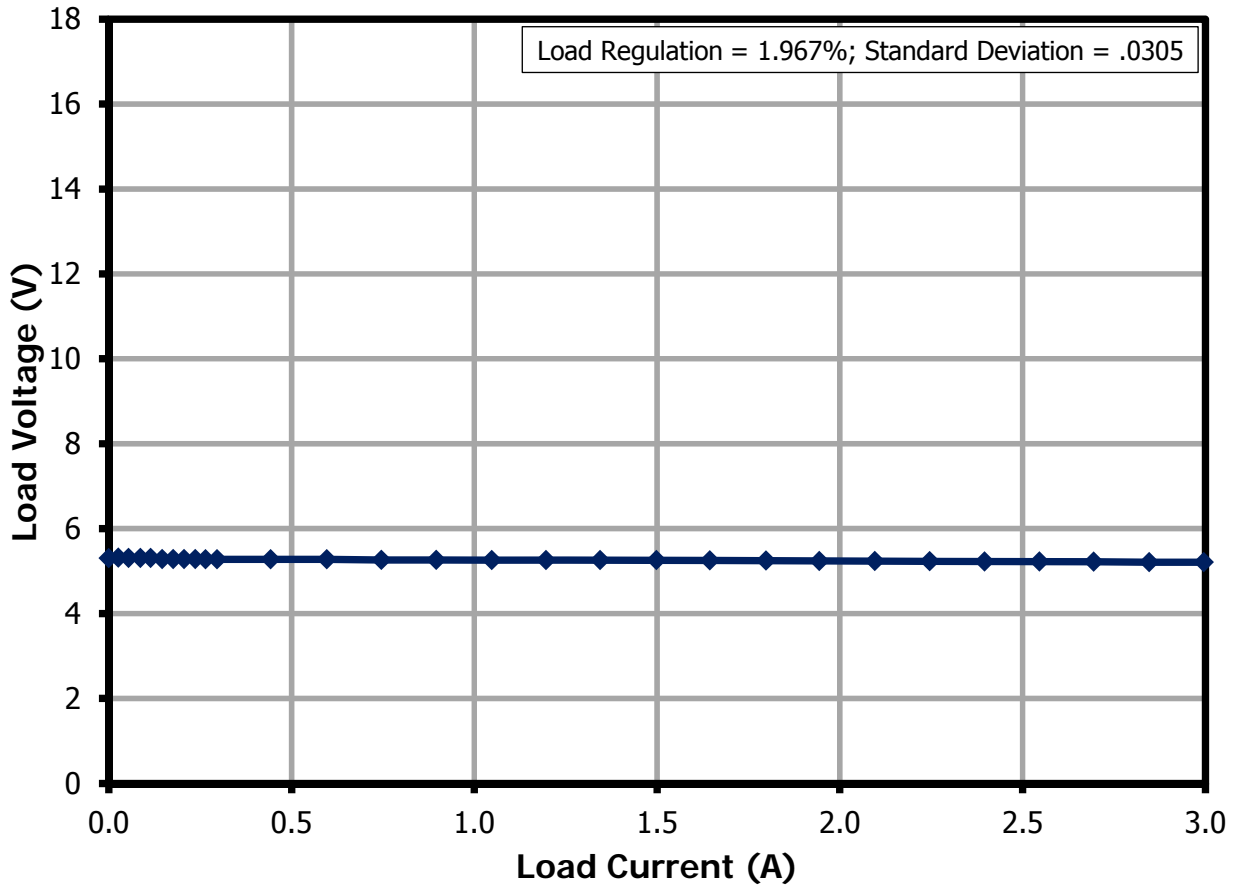


Figure 34 – Load Voltage vs. Load Current, Room Temperature,  $V_{OUT} = 5\text{ V}$ . 265 VAC, 50 Hz.



11.3.2.2  $V_{OUT} = 9\text{ V}$

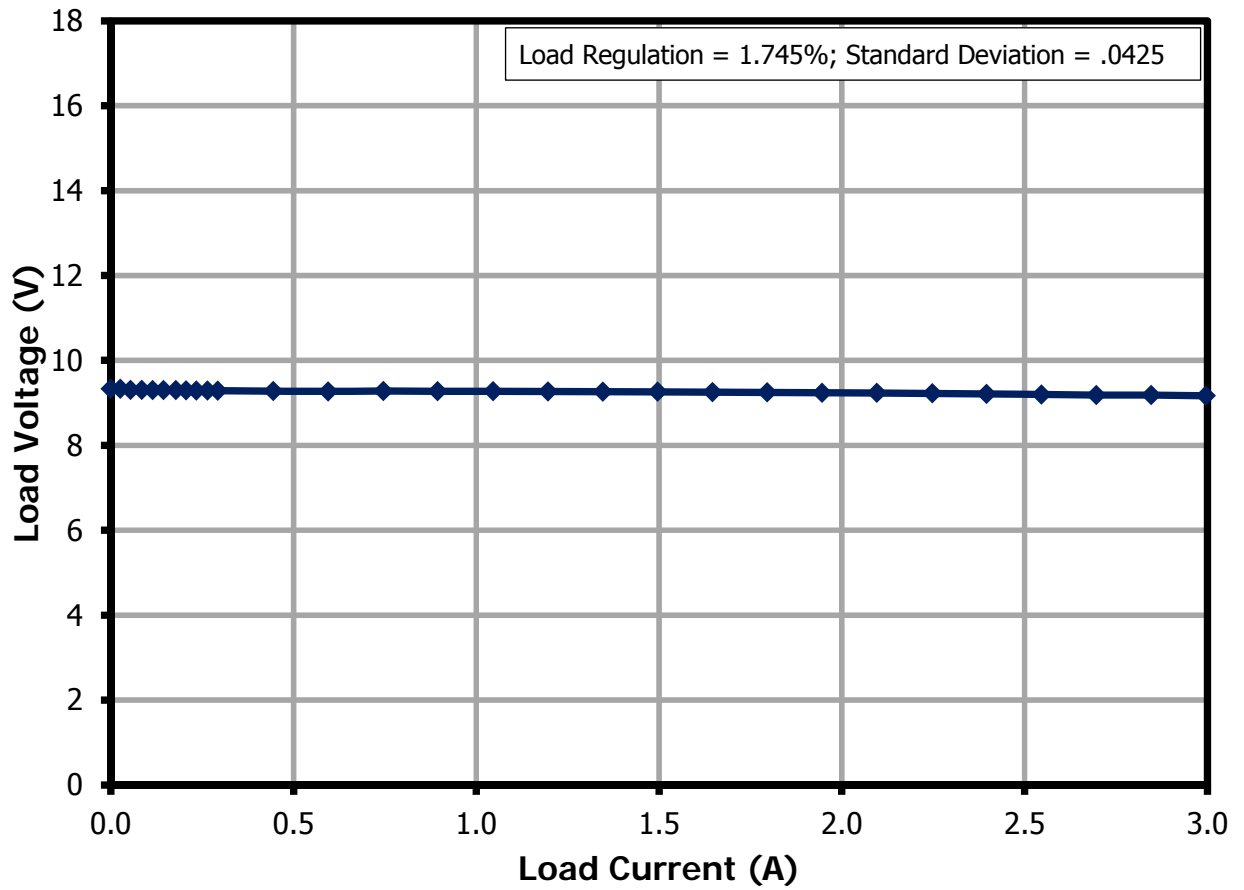


Figure 35 – Load Voltage vs. Load Current, Room Temperature,  $V_{OUT} = 9\text{ V}$ . 85 VAC, 60 Hz.



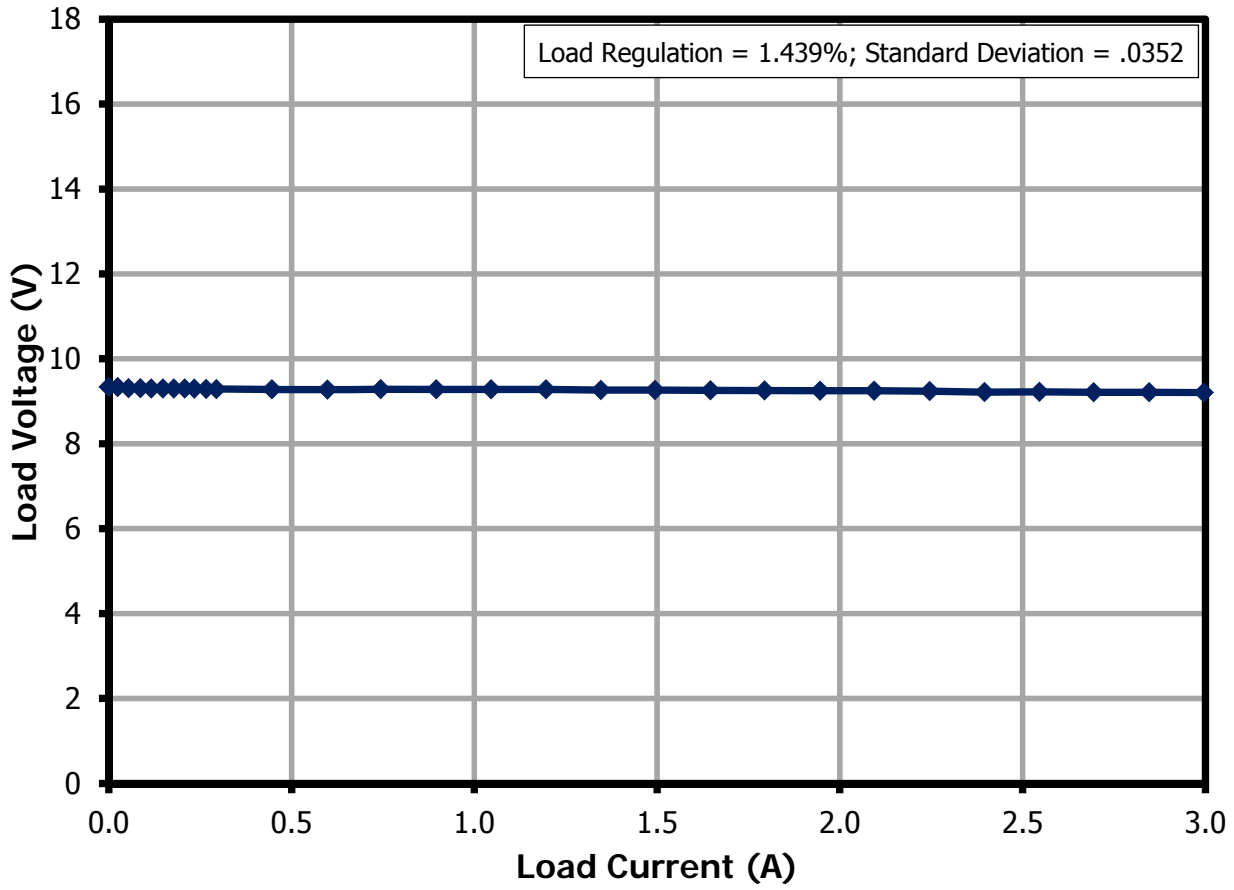


Figure 36 – Load Voltage vs. Load Current, Room Temperature,  $V_{OUT} = 9\text{ V}$ . 115 VAC, 60 Hz.

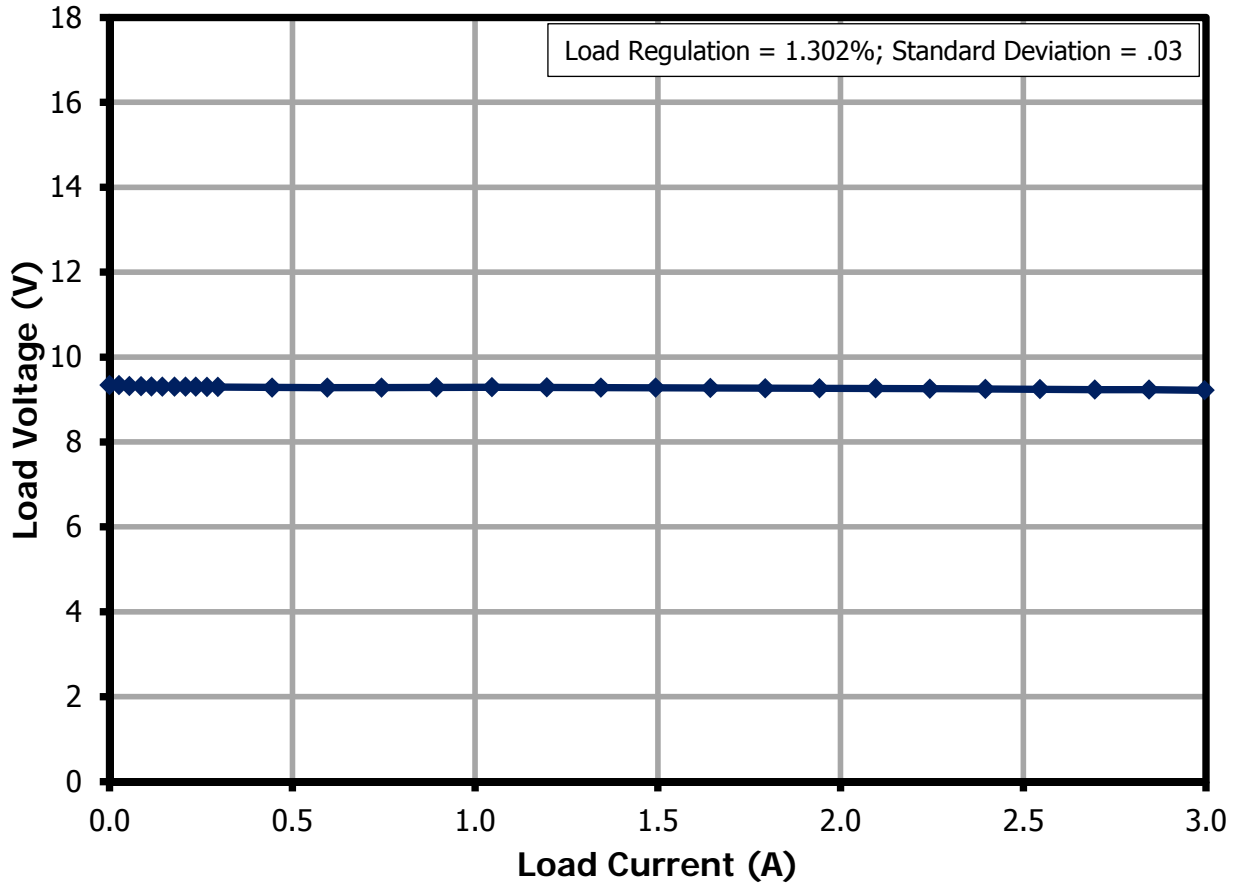


Figure 37 – Load Voltage vs. Load Current, Room Temperature,  $V_{OUT} = 9\text{ V}$ . 230 VAC, 50 Hz.



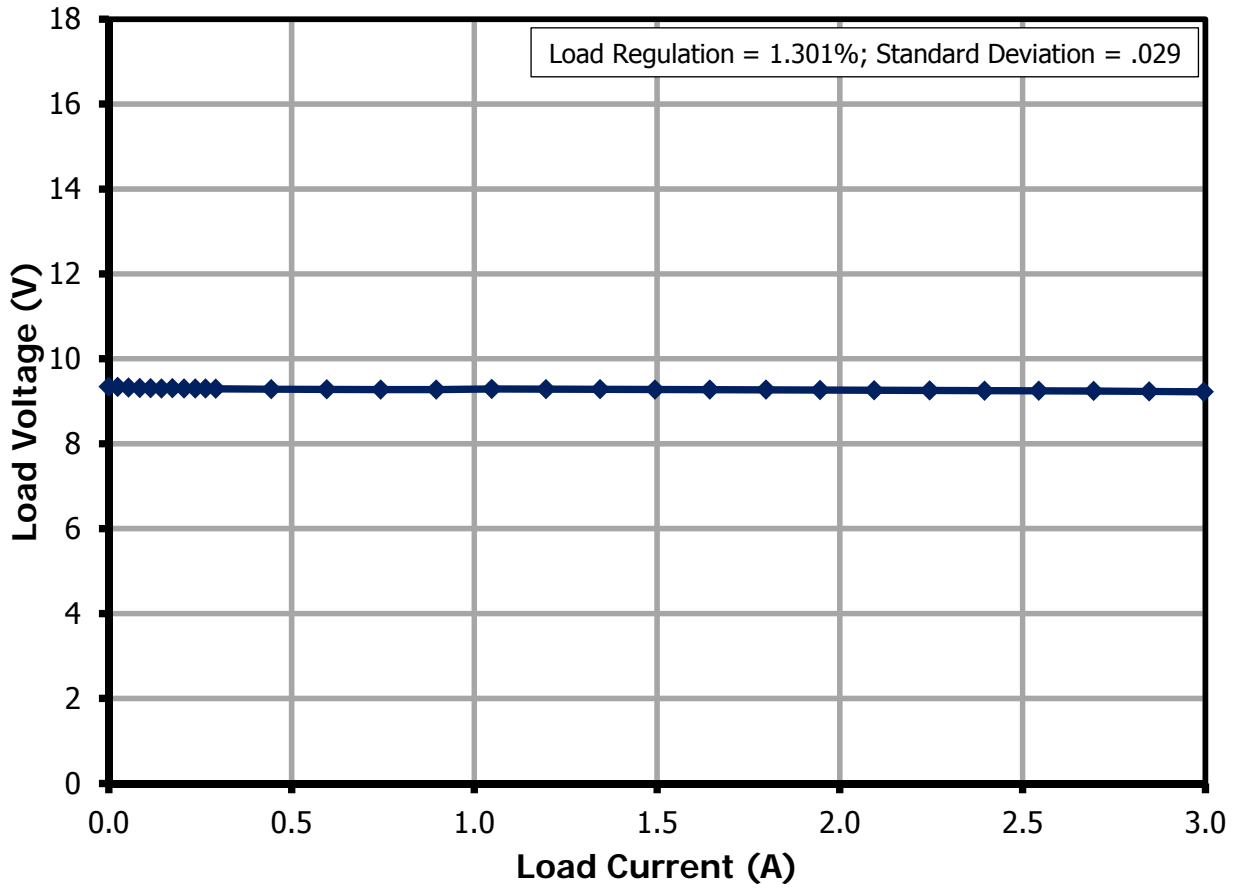


Figure 38 – Load Voltage vs. Load Current, Room Temperature,  $V_{OUT} = 9\text{ V}$ . 265 VAC, 50 Hz.

11.3.2.3  $V_{OUT} = 15\text{ V}$

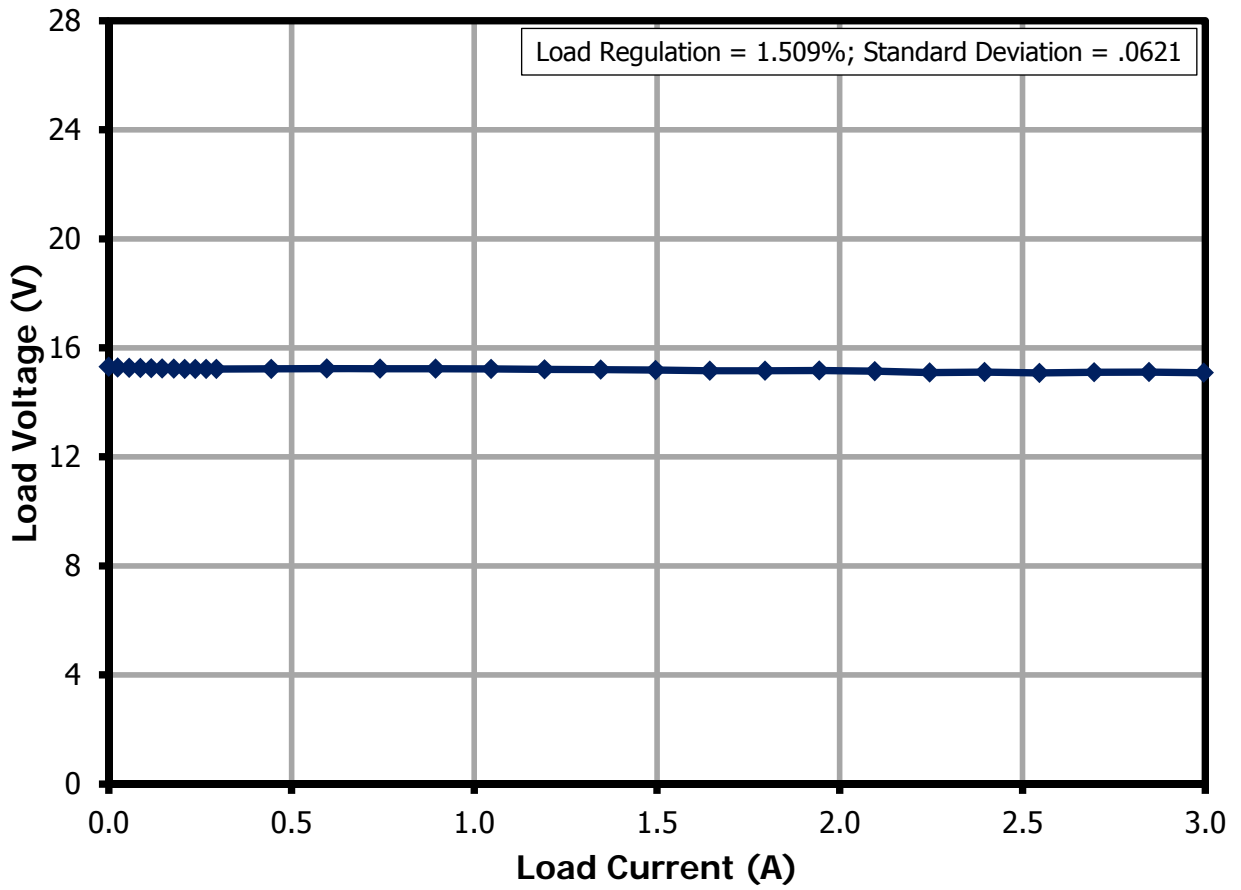


Figure 39 – Load Voltage vs. Load Current, Room Temperature,  $V_{OUT} = 15\text{ V}$ . 85 VAC, 60 Hz.



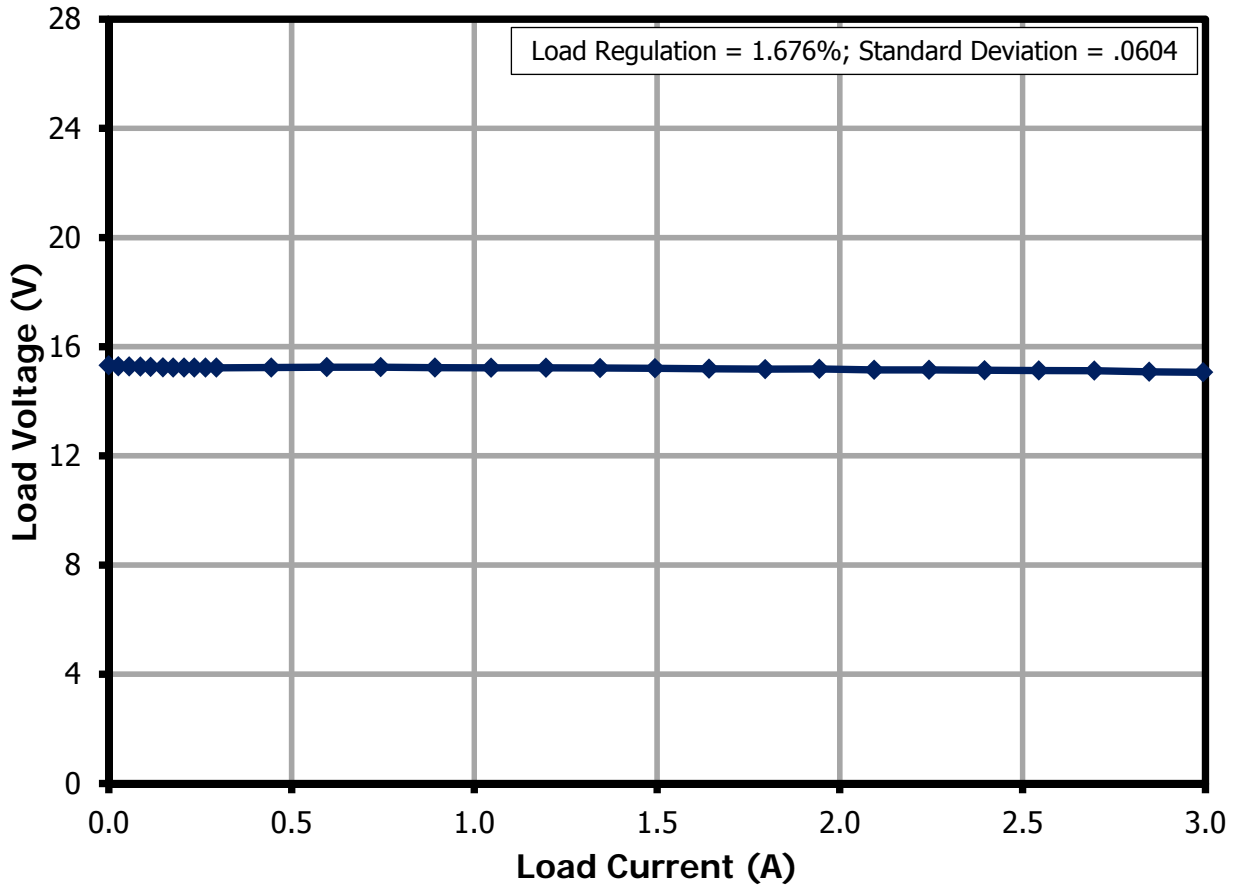


Figure 40 – Load Voltage vs. Load Current, Room Temperature,  $V_{OUT} = 15\text{ V}$ . 115 VAC, 60 Hz.



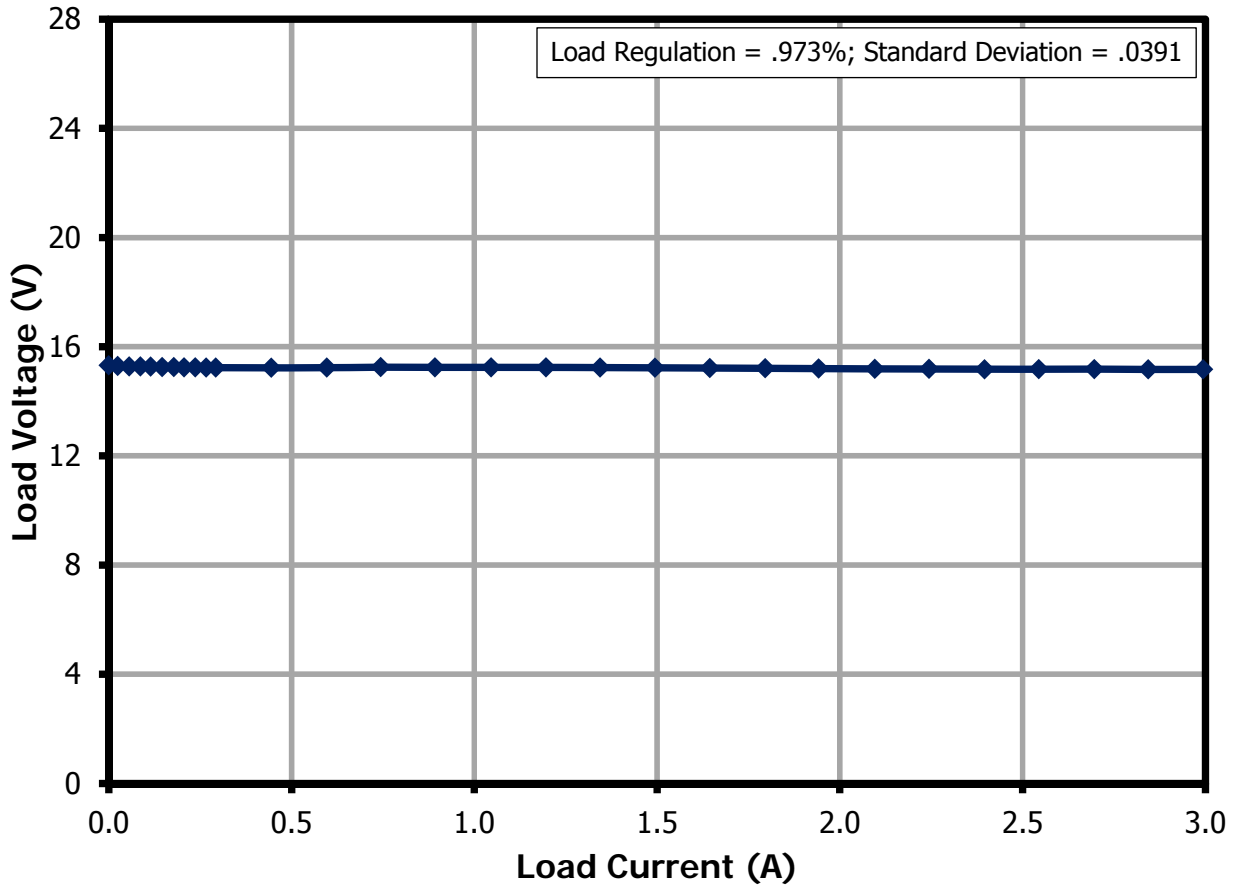


Figure 41 – Load Voltage vs. Load Current, Room Temperature,  $V_{OUT} = 15\text{ V}$ . 230 VAC, 50 Hz.



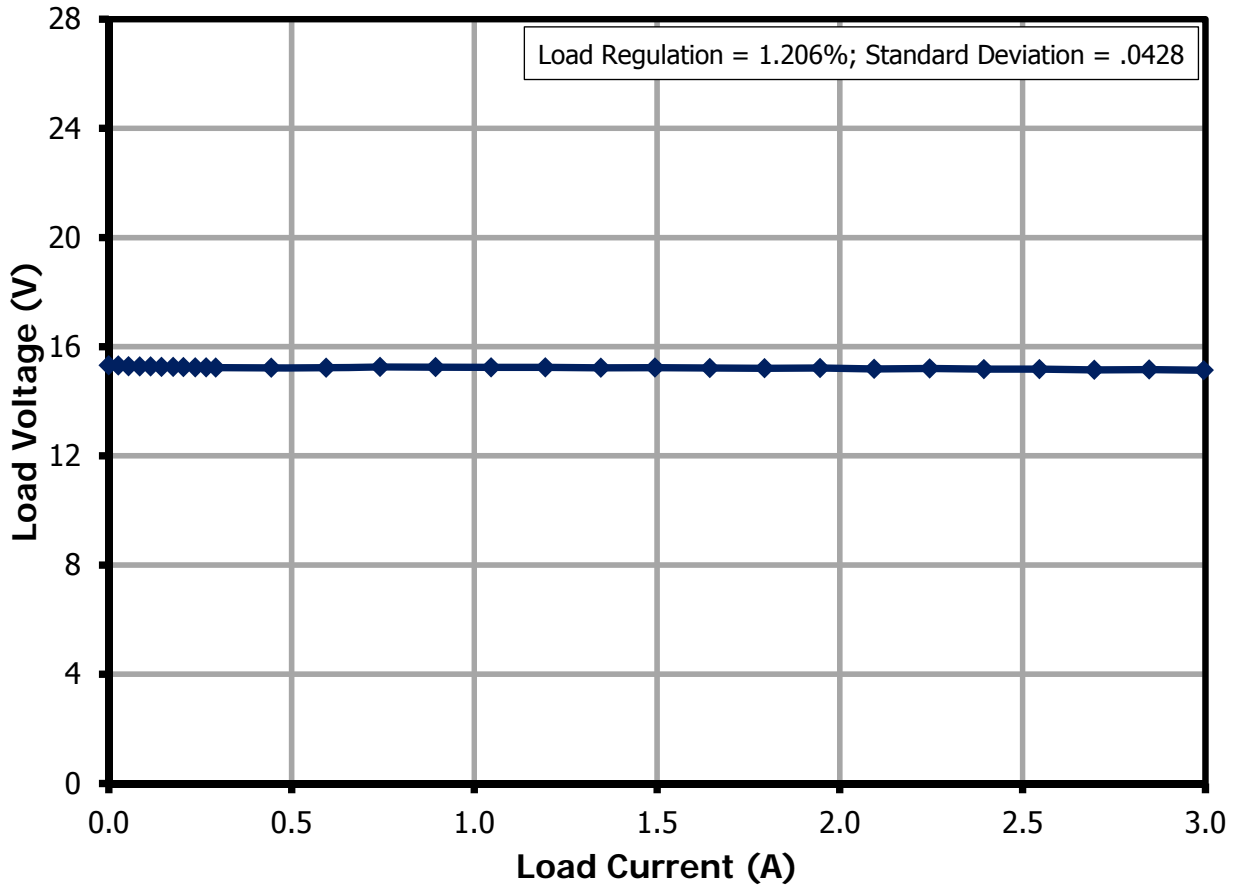


Figure 42 – Load Voltage vs. Load Current, Room Temperature,  $V_{OUT} = 15\text{ V}$ . 265 VAC, 50 Hz.

## 11.4 Thermal Performance

### 11.4.1 Test Set-up

Parameter	Value
Input Voltage	85 VAC, 60 Hz
Output	15 V, 3 A
Ambient Temperature	45 °C
Enclosure	3D Printed Box
Load	At the End of a 100 mΩ Type-C Cable (Google)

11.4.2 Test Data

11.4.2.1 Steady-State

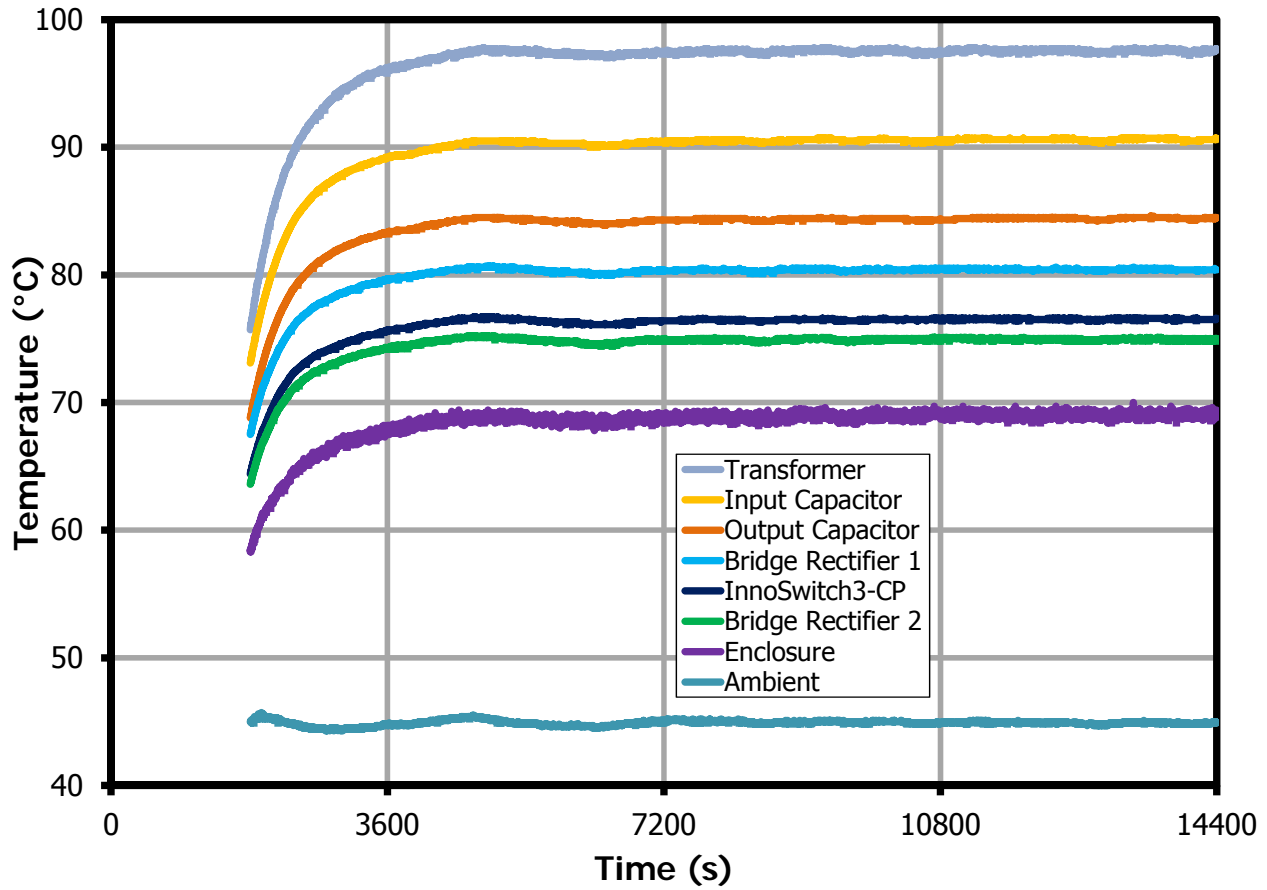


Figure 43 – Thermal Test Results.



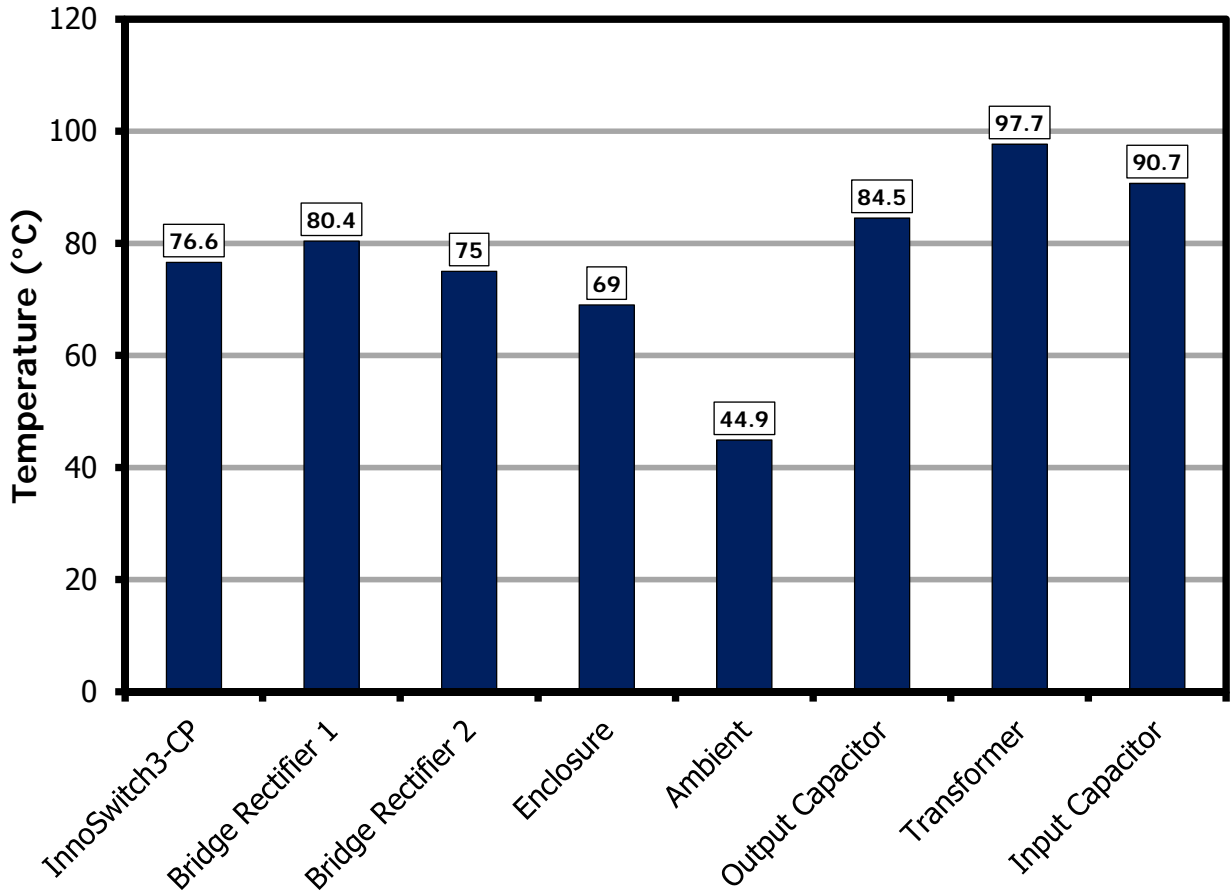


Figure 44 – Thermal Test Results.



11.4.2.2 Over Temperature Protection

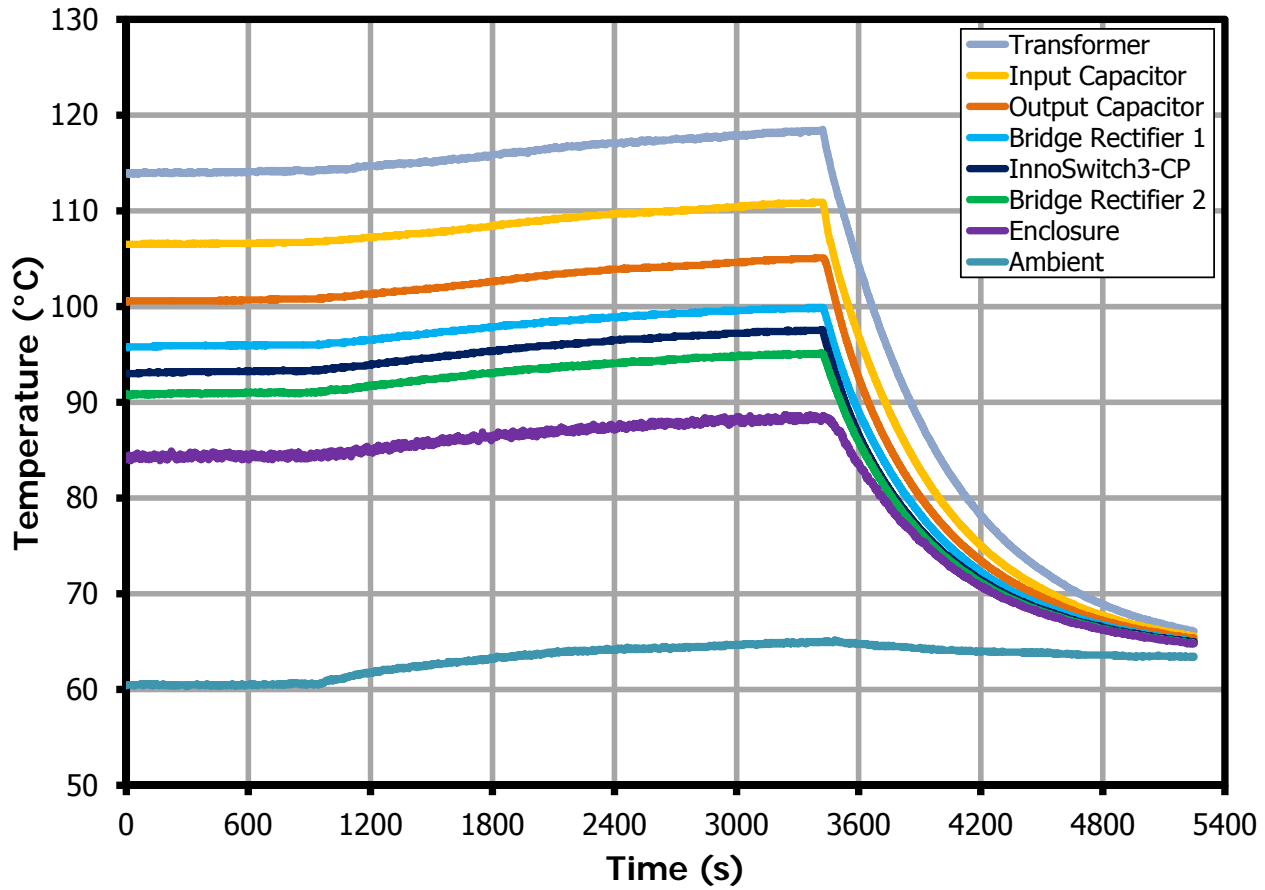


Figure 45 – Thermal Test Results.

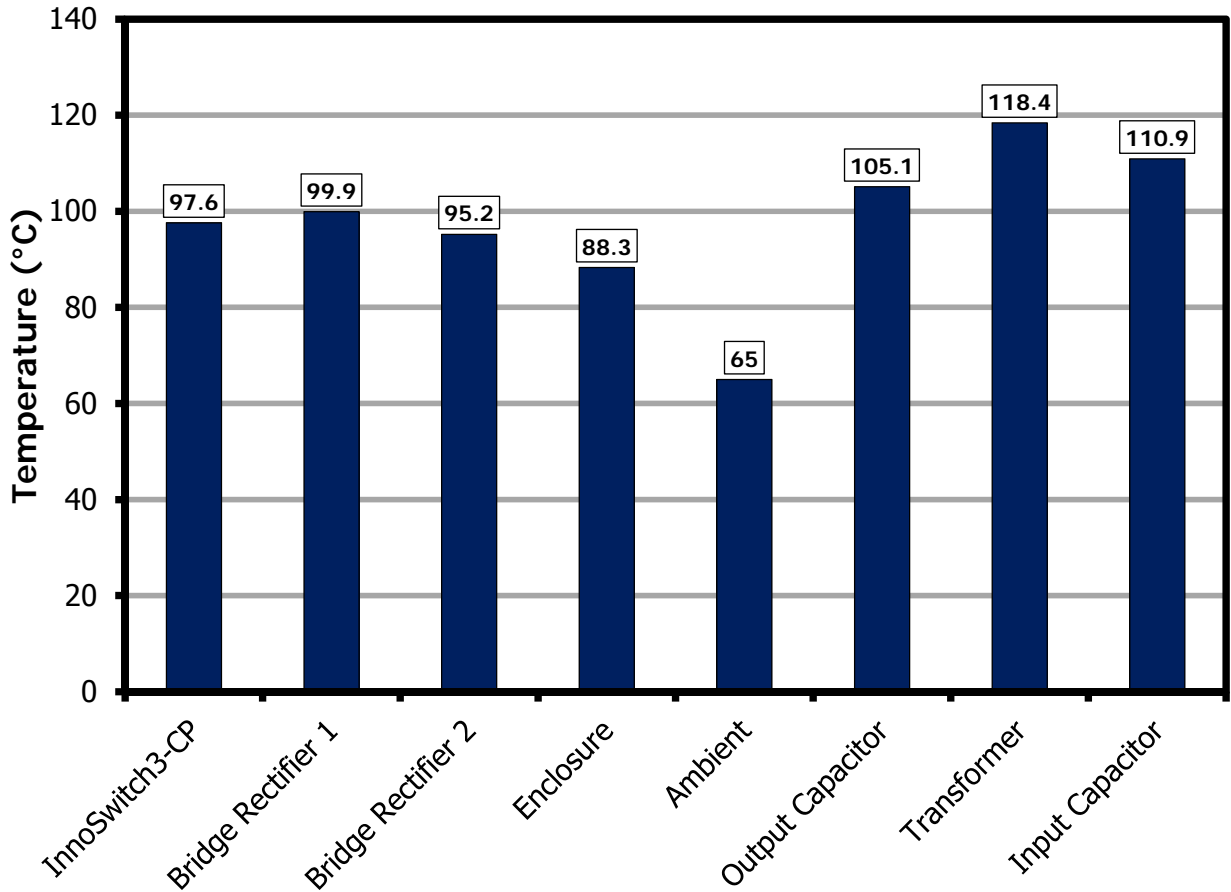


Figure 46 – Thermal Test Results.



## 11.5 Output Ripple Measurements

### 11.5.1 Test Set-up

For DC output ripple measurements, a modified oscilloscope test probe must be utilized in order to reduce spurious signals due to pick-up. Details of the probe modification are provided in the Figures below. The ripple was measured at the end of a Google type-C cable. The load end of the type-C cable was connected to Mini-PAT tool.

The 4987BA probe adapter is affixed with two capacitors tied in parallel across the probe tip. The capacitors include one (1) 0.1  $\mu\text{F}$ /50 V ceramic type and one (1) 47  $\mu\text{F}$ /50 V aluminum electrolytic. The aluminum electrolytic type capacitor is polarized, so proper polarity across DC outputs must be maintained (see below).

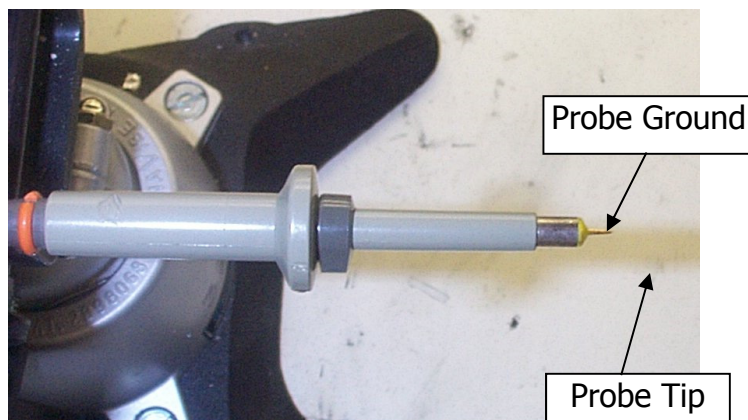


Figure 47 – Oscilloscope Probe Prepared for Ripple Measurement. (End Cap and Ground Lead Removed)

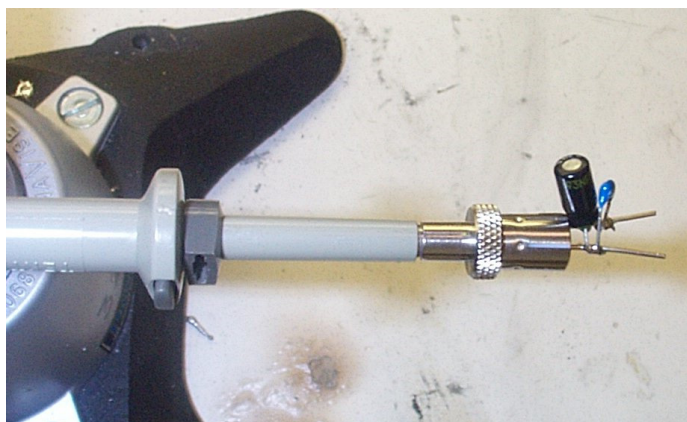


Figure 48 – Oscilloscope Probe with Probe Master ([www.probemaster.com](http://www.probemaster.com)) 4987A BNC Adapter. (Modified with wires for ripple measurement, and two parallel decoupling capacitors added)



11.5.2 Test Data

11.5.2.1  $V_{OUT} = 5 V$

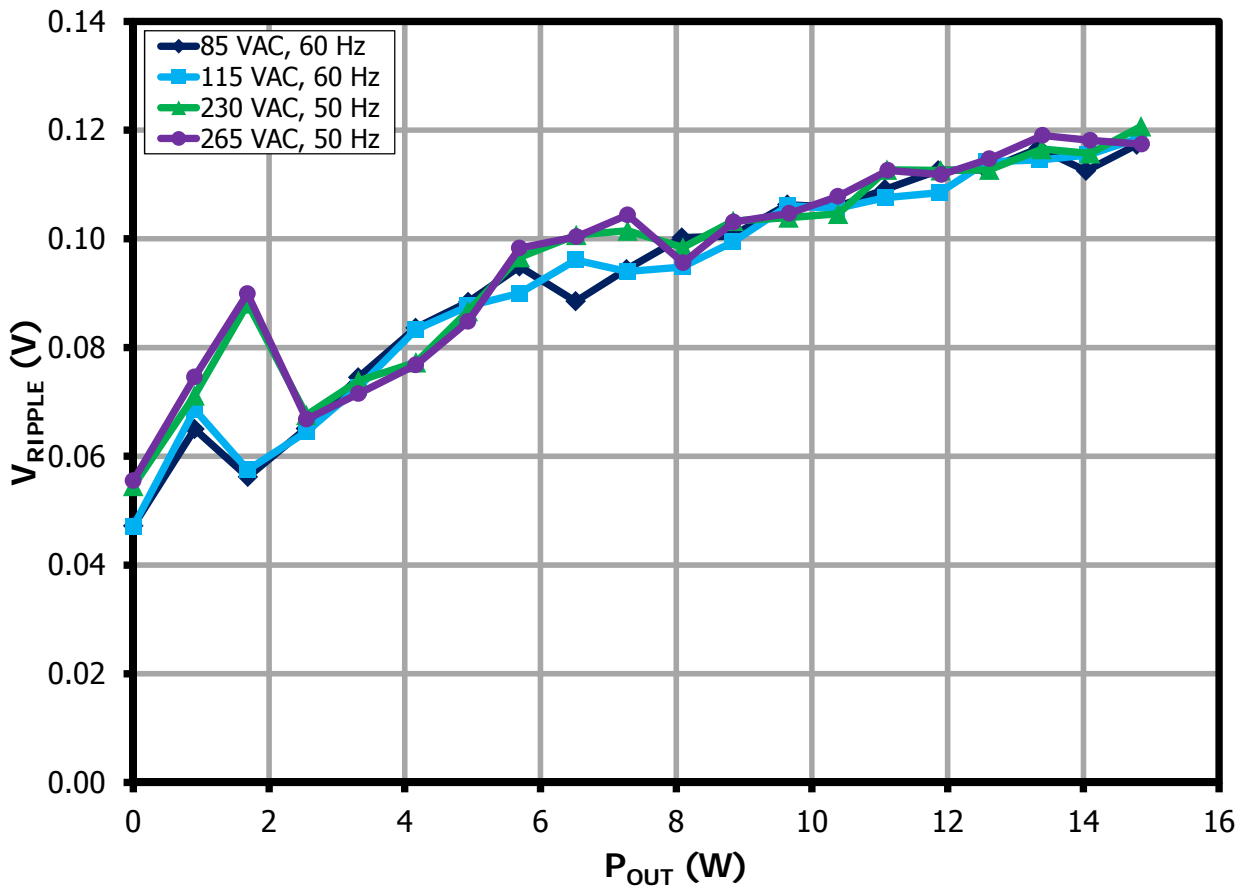


Figure 49 – Peak-Peak Load Ripple vs.  $P_{OUT}$ ,  $V_{OUT} = 5 V$ .



11.5.2.2  $V_{OUT} = 9\text{ V}$

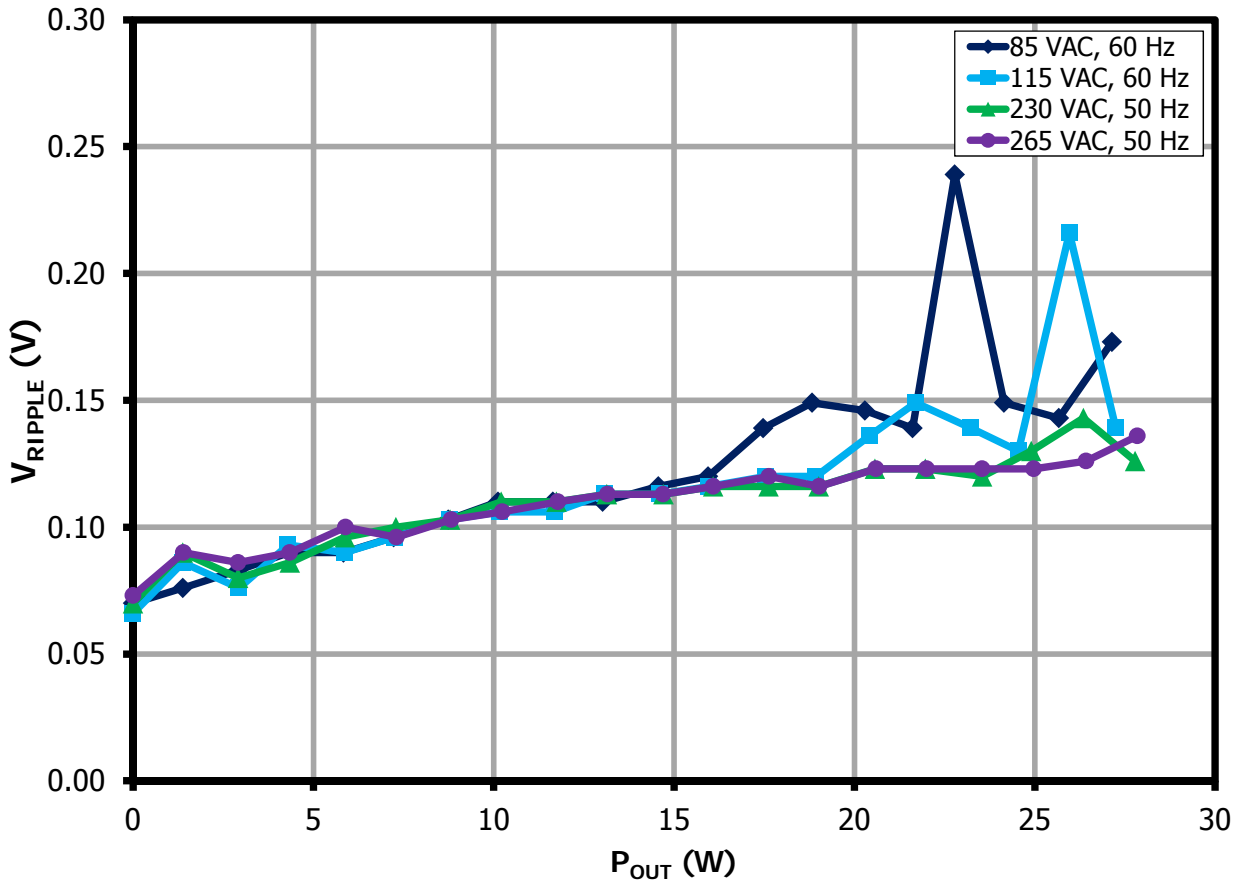


Figure 50 – Peak-Peak Load Ripple vs.  $P_{OUT}$ ,  $V_{OUT} = 9\text{ V}$ .

11.5.2.3  $V_{OUT} = 15\text{ V}$

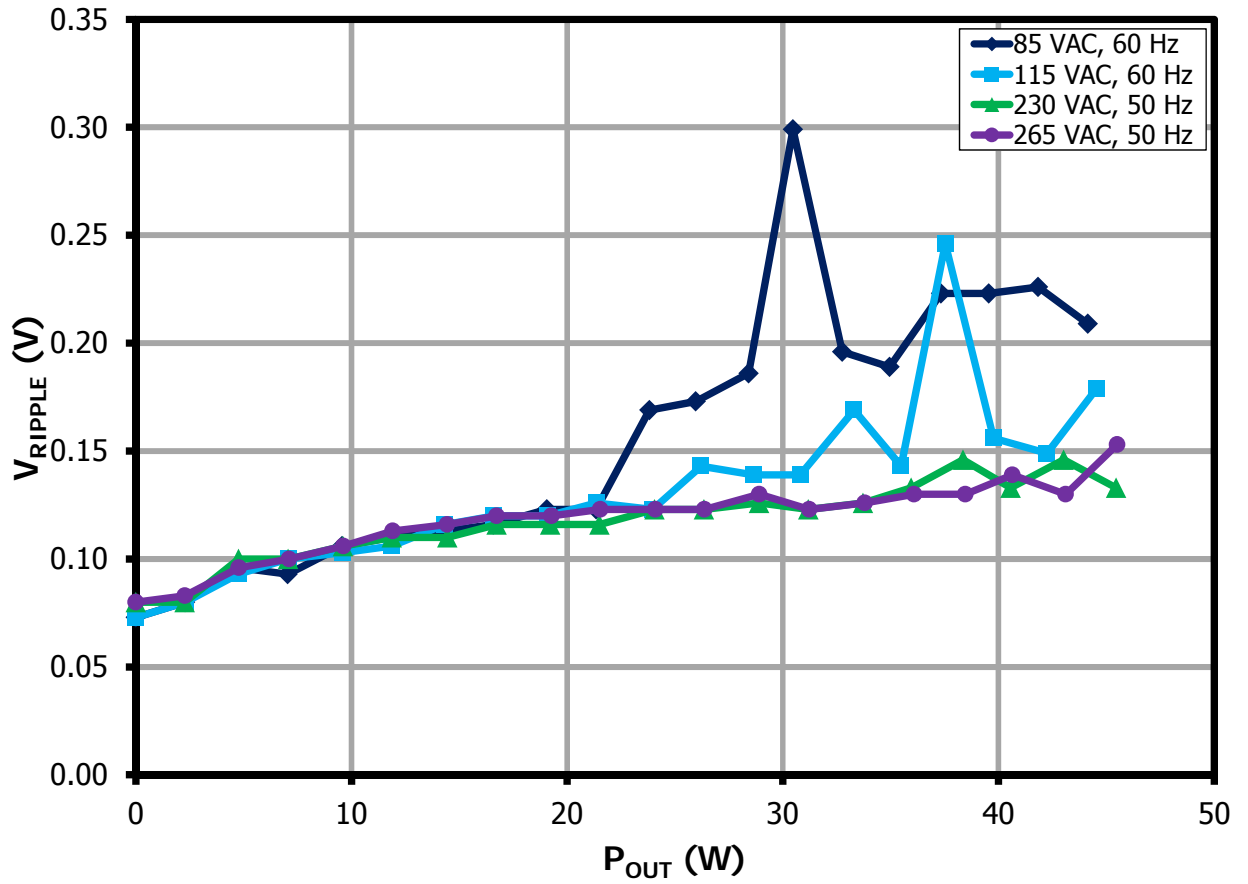


Figure 51 – Peak-Peak Load Ripple vs.  $P_{OUT}$ ,  $V_{OUT} = 15\text{ V}$ .

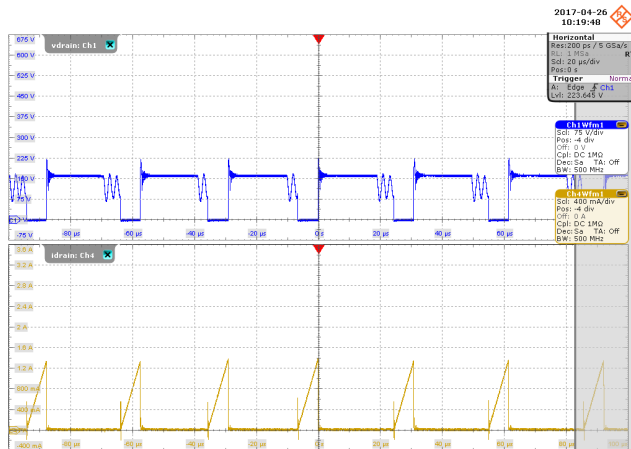


## 12 Waveforms

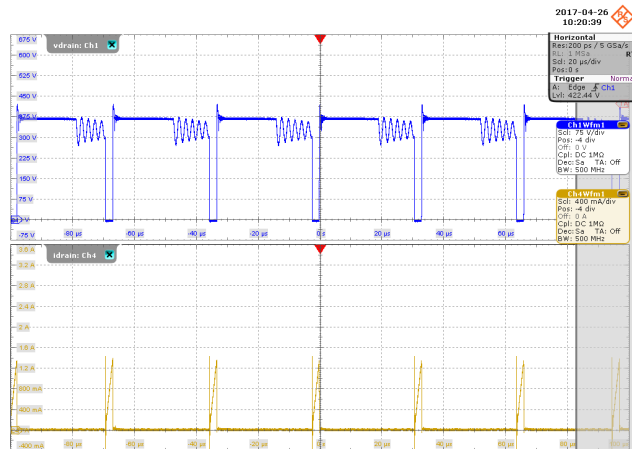
### 12.1 Switching Waveforms

#### 12.1.1 Primary Drain and Current

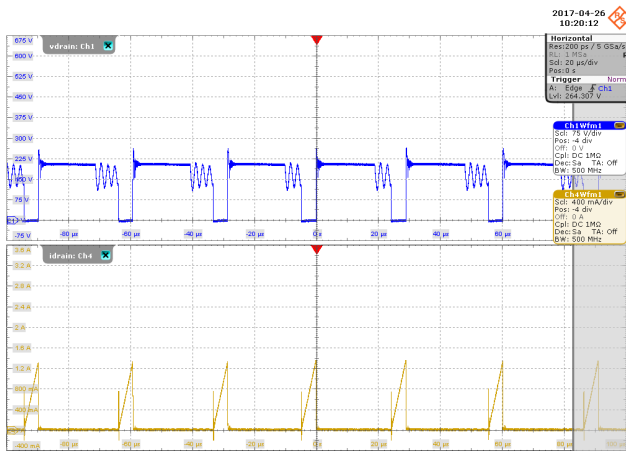
##### 12.1.1.1 $V_{OUT} = 5 V$



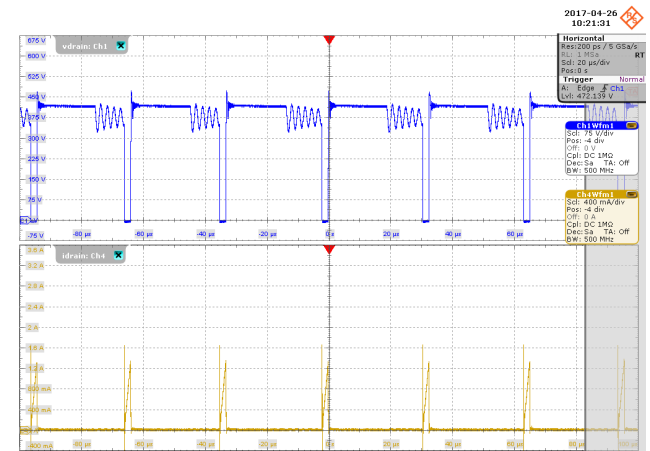
**Figure 52** – Primary Drain Waveforms,  $V_{OUT} = 5 V$ .  
 Input: 85 VAC, 60 Hz.  
 Output: 5 V, 3 A.  
 Primary Drain Voltage: 75 V / div.  
 Primary Drain Current: 400 mA / div.  
 Time Scale: 20  $\mu s$  / div.



**Figure 53** – Primary Drain Waveforms,  $V_{OUT} = 5 V$ .  
 Input: 230 VAC, 50 Hz.  
 Output: 5 V, 3 A.  
 Primary Drain Voltage: 75 V / div.  
 Primary Drain Current: 400 mA / div.  
 Time Scale: 20  $\mu s$  / div.

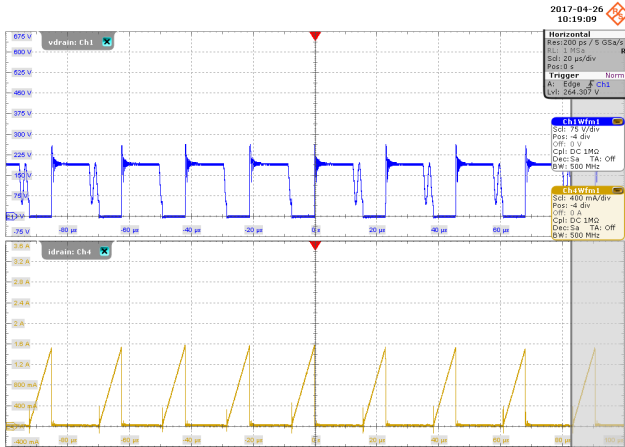


**Figure 54** – Primary Drain Waveforms,  $V_{OUT} = 5\text{ V}$ .  
 Input: 115 VAC, 60 Hz.  
 Output: 5 V, 3 A.  
 Primary Drain Voltage: 75 V / div.  
 Primary Drain Current: 400 mA / div.  
 Time Scale: 20  $\mu\text{s}$  / div.

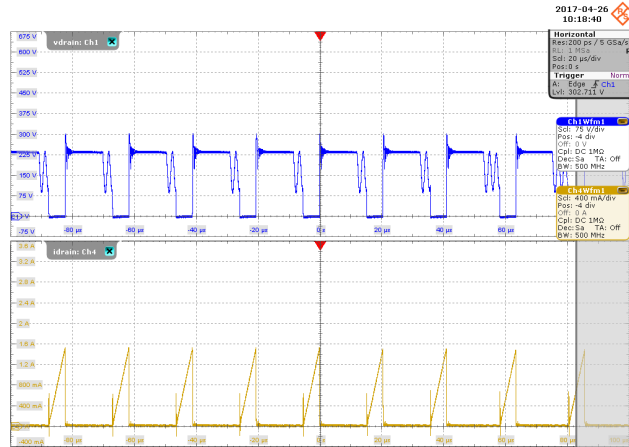


**Figure 55** – Primary Drain Waveforms,  $V_{OUT} = 5\text{ V}$ .  
 Input: 265 VAC, 50 Hz.  
 Output: 5 V, 3 A.  
 Primary Drain Voltage: 75 V / div.  
 Primary Drain Current: 400 mA / div.  
 Time Scale: 20  $\mu\text{s}$  / div.

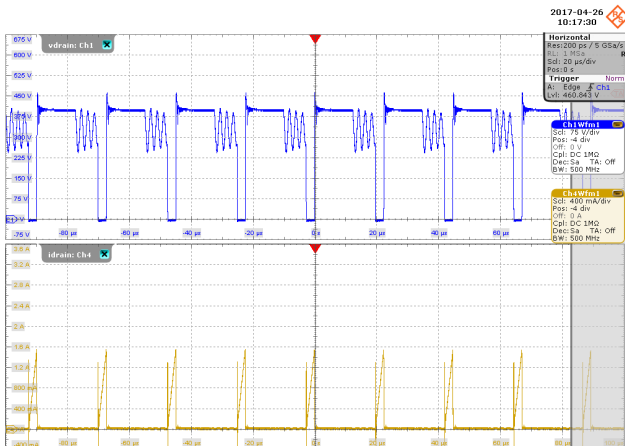
12.1.1.2  $V_{OUT} = 9\text{ V}$



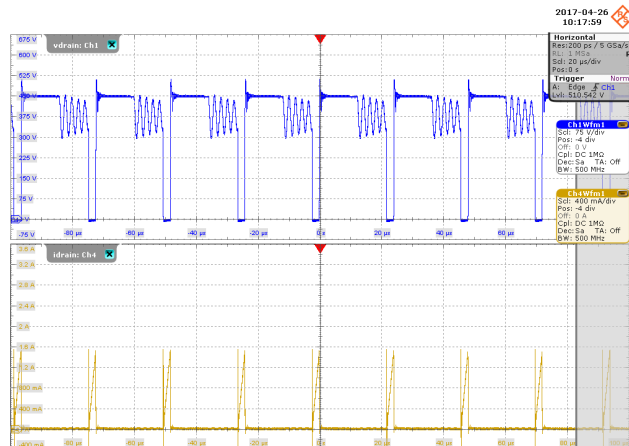
**Figure 56** – Primary Drain Waveforms,  $V_{OUT} = 9\text{ V}$ .  
 Input: 85 VAC, 60 Hz.  
 Output: 9 V, 3 A.  
 Primary Drain Voltage: 75 V / div.  
 Primary Drain Current: 400 mA / div.  
 Time Scale: 20  $\mu\text{s}$  / div.



**Figure 57** – Primary Drain Waveforms,  $V_{OUT} = 9\text{ V}$ .  
 Input: 230 VAC, 50 Hz.  
 Output: 9 V, 3 A.  
 Primary Drain Voltage: 75 V / div.  
 Primary Drain Current: 400 mA / div.  
 Time Scale: 20  $\mu\text{s}$  / div.

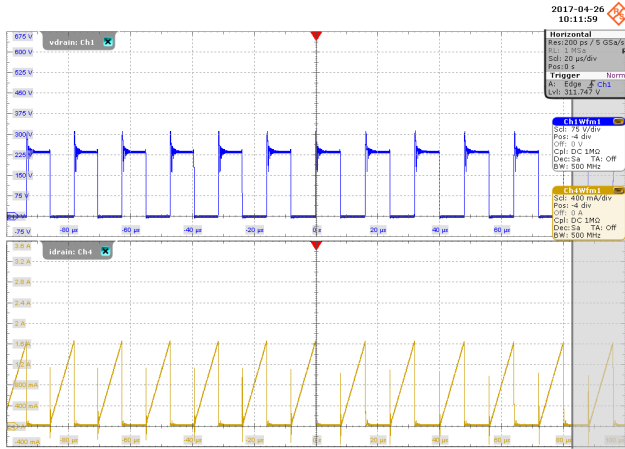


**Figure 58** – Primary Drain Waveforms,  $V_{OUT} = 9\text{ V}$ .  
 Input: 115 VAC, 60 Hz.  
 Output: 9 V, 3 A.  
 Primary Drain Voltage: 75 V / div.  
 Primary Drain Current: 400 mA / div.  
 Time Scale: 20  $\mu\text{s}$  / div.

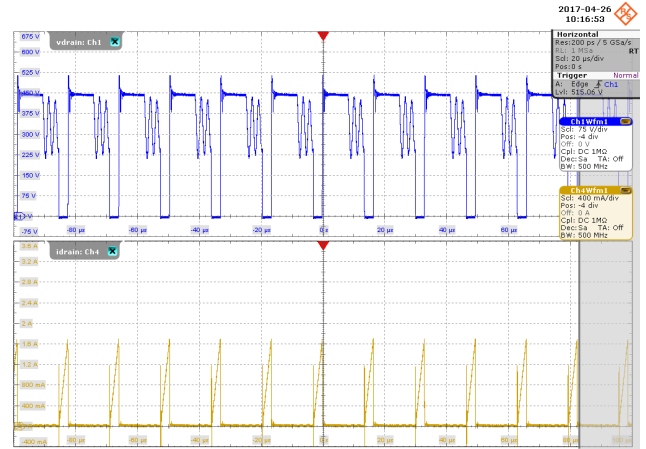


**Figure 59** – Primary Drain Waveforms,  $V_{OUT} = 9\text{ V}$ .  
 Input: 265 VAC, 50 Hz.  
 Output: 9 V, 3 A.  
 Primary Drain Voltage: 75 V / div.  
 Primary Drain Current: 400 mA / div.  
 Time Scale: 20  $\mu\text{s}$  / div.

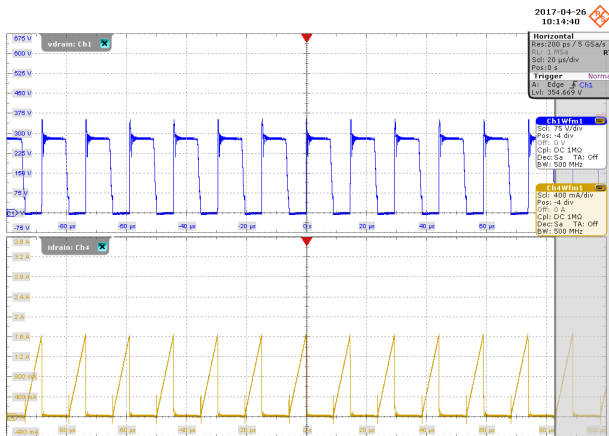
12.1.1.3  $V_{OUT} = 15 V$



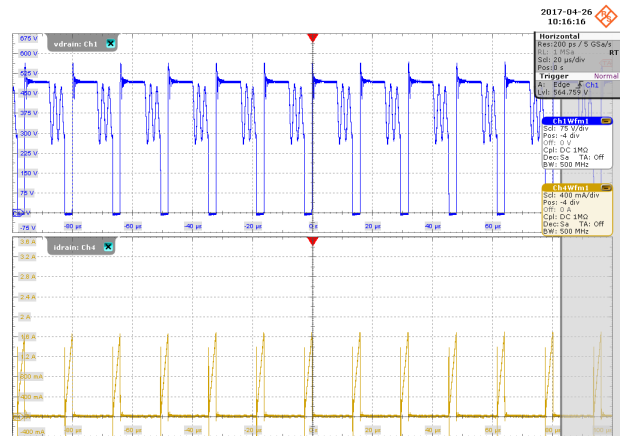
**Figure 60** – Primary Drain Waveforms,  $V_{OUT} = 15 V$ .  
 Input: 85 VAC, 60 Hz.  
 Output: 15 V, 3 A.  
 Primary Drain Voltage: 75 V / div.  
 Primary Drain Current: 400 mA / div.  
 Time Scale: 20  $\mu s$  / div.



**Figure 61** – Primary Drain Waveforms,  $V_{OUT} = 15 V$ .  
 Input: 230 VAC, 50 Hz.  
 Output: 15 V, 3 A.  
 Primary Drain Voltage: 75 V / div.  
 Primary Drain Current: 400 mA / div.  
 Time Scale: 20  $\mu s$  / div.



**Figure 62** – Primary Drain Waveforms,  $V_{OUT} = 15 V$ .  
 Input: 115 VAC, 60 Hz.  
 Output: 15 V, 3 A.  
 Primary Drain Voltage: 75 V / div.  
 Primary Drain Current: 400 mA / div.  
 Time Scale: 20  $\mu s$  / div.

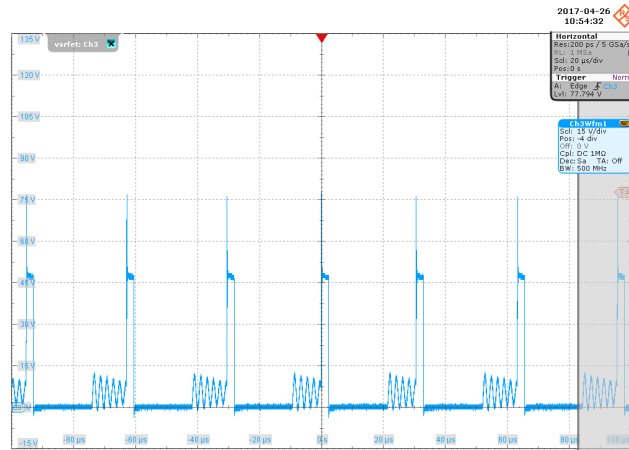
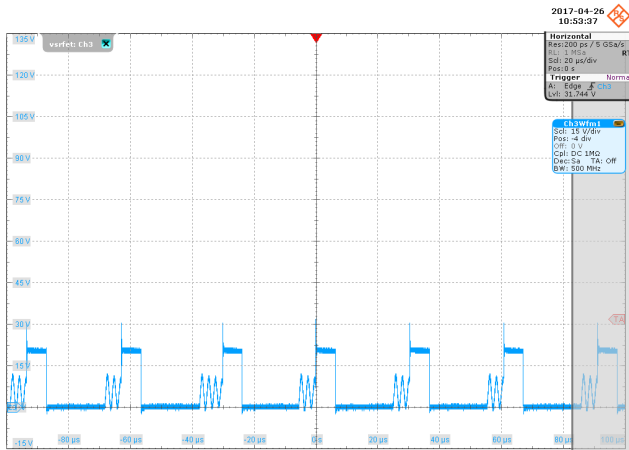


**Figure 63** – Primary Drain Waveforms,  $V_{OUT} = 15 V$ .  
 Input: 265 VAC, 50 Hz.  
 Output: 15 V, 3 A.  
 Primary Drain Voltage: 75 V / div.  
 Primary Drain Current: 400 mA / div.  
 Time Scale: 20  $\mu s$  / div.



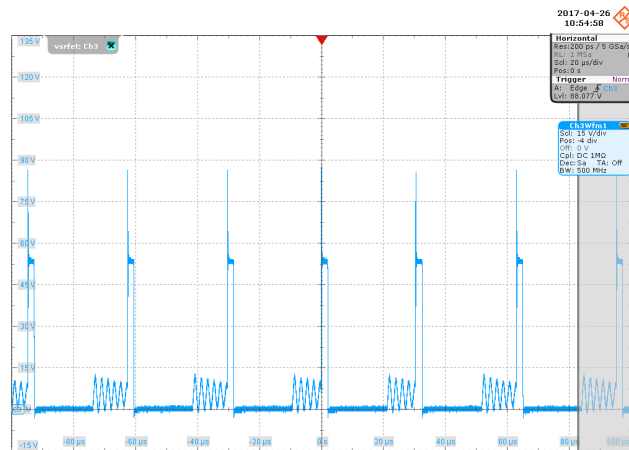
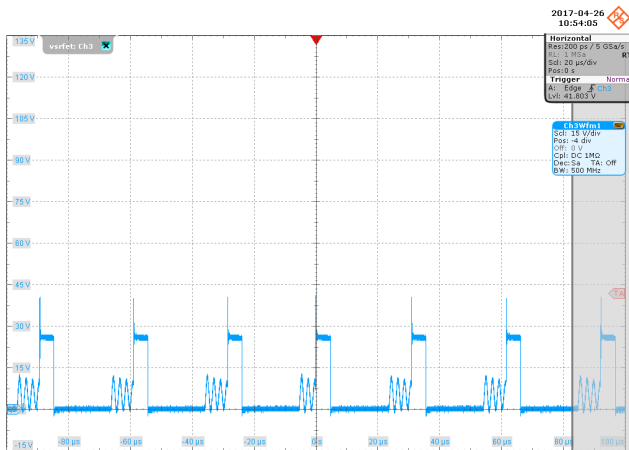
12.1.2 Steady-State Secondary Drain Voltage

12.1.2.1  $V_{OUT} = 5 V$



**Figure 64** – Steady-State Secondary Drain Voltage,  $V_{OUT} = 5 V$ .  
 Input: 85 VAC, 60 Hz.  
 Output: 5 V, 3 A.  
 Secondary Drain Voltage: 15 V / div.  
 Time Scale: 20  $\mu s$  / div.  
 Peak Voltage: 31.74 V.

**Figure 65** – Steady-State Secondary Drain Voltage,  $V_{OUT} = 5 V$ .  
 Input: 230 VAC, 50 Hz.  
 Output: 5 V, 3 A.  
 Secondary Drain Voltage: 15 V / div.  
 Time Scale: 20  $\mu s$  / div.  
 Peak Voltage: 77.8 V.

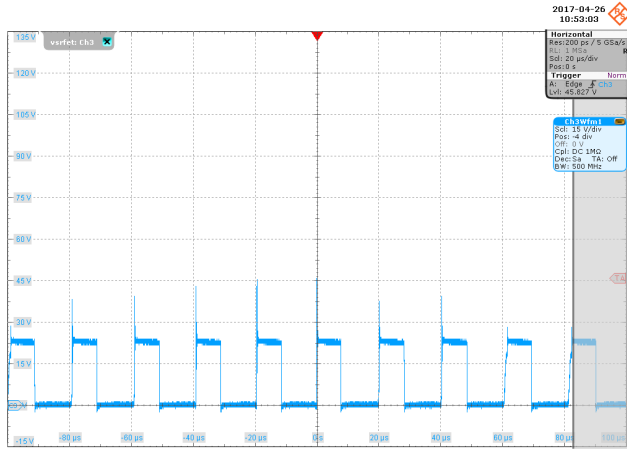


**Figure 66** – Steady-State Secondary Drain Voltage,  $V_{OUT} = 5 V$ .  
 Input: 115 VAC, 60 Hz.  
 Output: 5 V, 3 A.  
 Secondary Drain Voltage: 15 V / div.  
 Time Scale: 20  $\mu s$  / div.  
 Peak Voltage: 41.8 V.

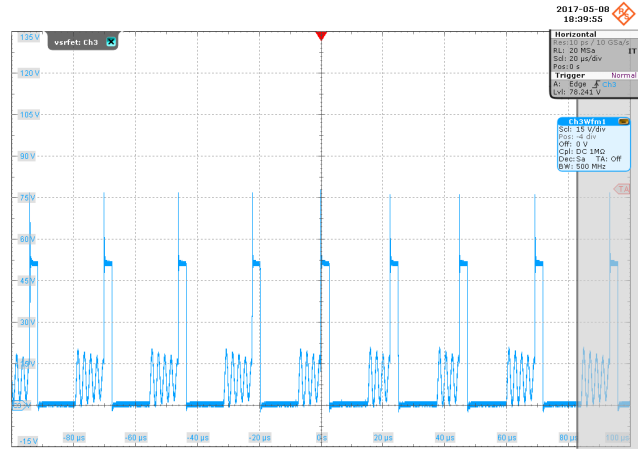
**Figure 67** – Steady-State Secondary Drain Voltage,  $V_{OUT} = 5 V$ .  
 Input: 265 VAC, 50 Hz.  
 Output: 5 V, 3 A.  
 Secondary Drain Voltage: 15 V / div.  
 Time Scale: 20  $\mu s$  / div.  
 Peak Voltage: 88 V.



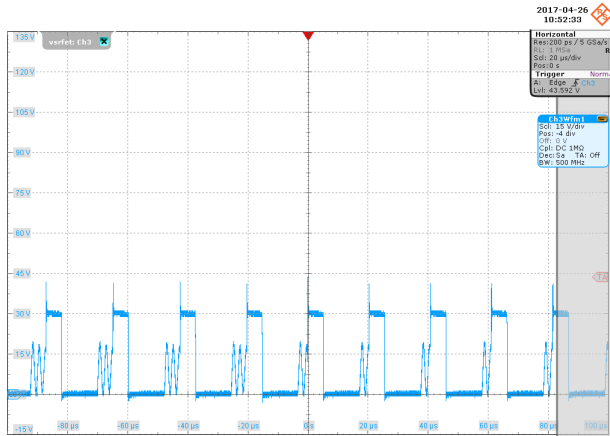
12.1.2.2  $V_{OUT} = 9\text{ V}$



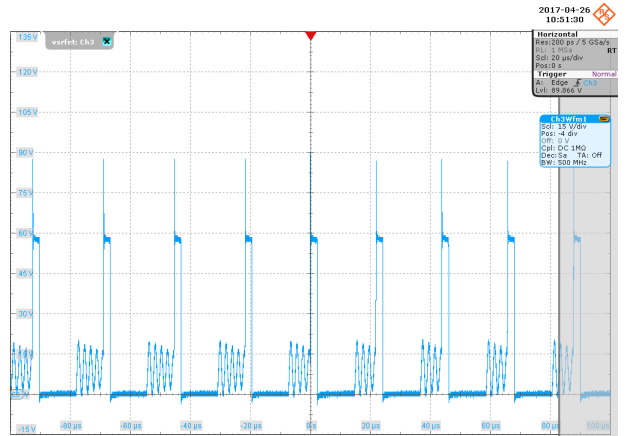
**Figure 68** – Steady-State Secondary Drain Voltage,  $V_{OUT} = 9\text{ V}$ .  
 Input: 85 VAC, 60 Hz.  
 Output: 9 V, 3 A.  
 Secondary Drain Voltage: 15 V / div.  
 Time Scale: 20  $\mu\text{s}$  / div.  
 Peak Voltage: 45.82 V.



**Figure 69** – Steady-State Secondary Drain Voltage,  $V_{OUT} = 9\text{ V}$ .  
 Input: 230 VAC, 50 Hz.  
 Output: 9 V, 3 A.  
 Secondary Drain Voltage: 15 V / div.  
 Time Scale: 20  $\mu\text{s}$  / div.  
 Peak Voltage: 78.24 V.

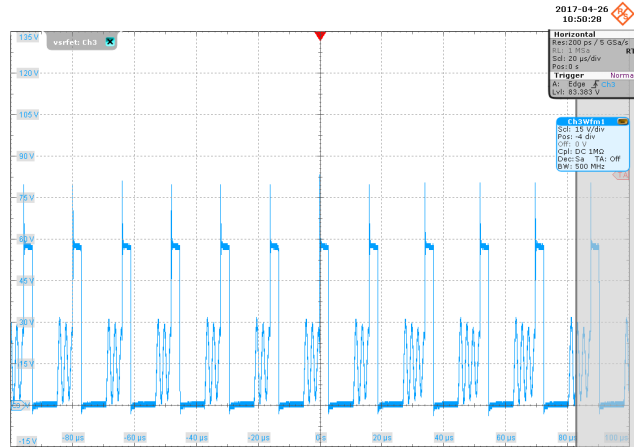
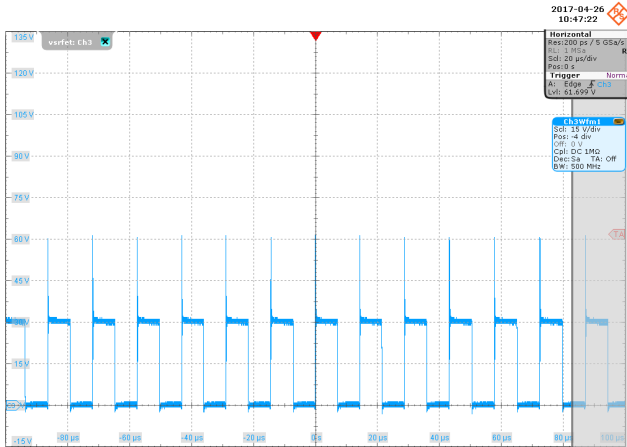


**Figure 70** – Steady-State Secondary Drain Voltage,  $V_{OUT} = 9\text{ V}$ .  
 Input: 115 VAC, 60 Hz.  
 Output: 9 V, 3 A.  
 Secondary Drain Voltage: 15 V / div.  
 Time Scale: 20  $\mu\text{s}$  / div.  
 Peak Voltage: 43.6 V.



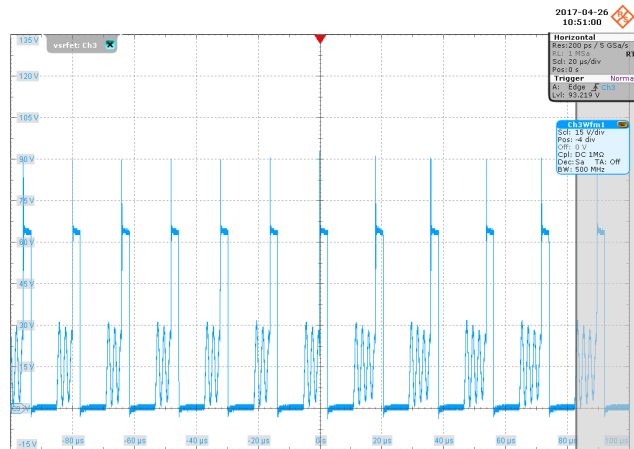
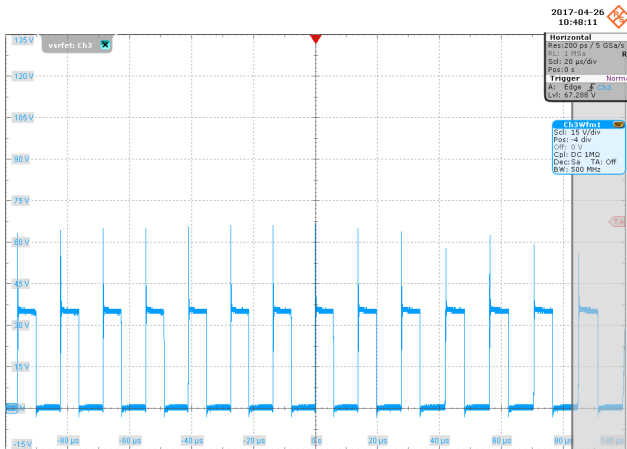
**Figure 71** – Steady-State Secondary Drain Voltage,  $V_{OUT} = 9\text{ V}$ .  
 Input: 265 VAC, 50 Hz.  
 Output: 9 V, 3 A.  
 Secondary Drain Voltage: 15 V / div.  
 Time Scale: 20  $\mu\text{s}$  / div.  
 Peak Voltage: 89.86 V.

12.1.2.3  $V_{OUT} = 15\text{ V}$



**Figure 72** – Steady-State Secondary Drain Voltage,  $V_{OUT} = 15\text{ V}$ .  
 Input: 85 VAC, 60 Hz.  
 Output: 15 V, 3 A.  
 Secondary Drain Voltage: 15 V / div.  
 Time Scale: 20  $\mu\text{s}$  / div.  
 Peak Voltage: 61.7 V.

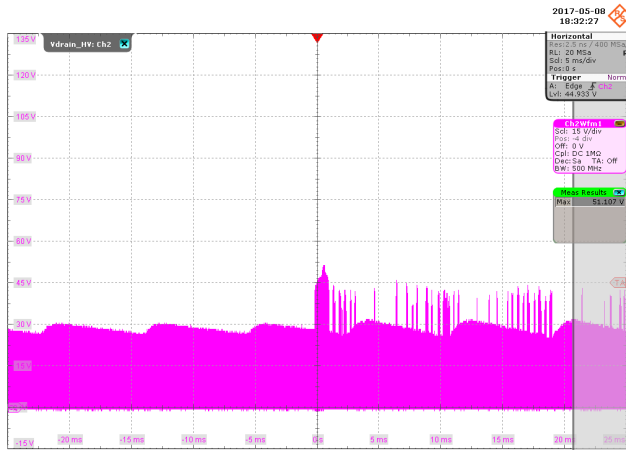
**Figure 73** – Steady-State Secondary Drain Voltage,  $V_{OUT} = 15\text{ V}$ .  
 Input: 230 VAC, 50 Hz.  
 Output: 15 V, 3 A.  
 Secondary Drain Voltage: 15 V / div.  
 Time Scale: 20  $\mu\text{s}$  / div.  
 Peak Voltage: 83.4 V.



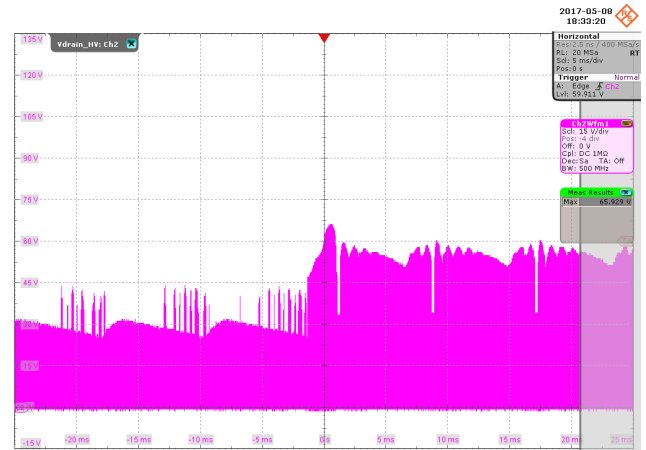
**Figure 74** – Steady-State Secondary Drain Voltage,  $V_{OUT} = 15\text{ V}$ .  
 Input: 115 VAC, 60 Hz.  
 Output: 15 V, 3 A.  
 Secondary Drain Voltage: 15 V / div.  
 Time Scale: 20  $\mu\text{s}$  / div.  
 Peak Voltage: 67.3 V.

**Figure 75** – Steady-State Secondary Drain Voltage,  $V_{OUT} = 15\text{ V}$ .  
 Input: 265 VAC, 50 Hz.  
 Output: 15 V, 3 A.  
 Secondary Drain Voltage: 15 V / div.  
 Time Scale: 20  $\mu\text{s}$  / div.  
 Peak Voltage: 93.2 V.

## 12.1.3 Transient Secondary Drain Voltage

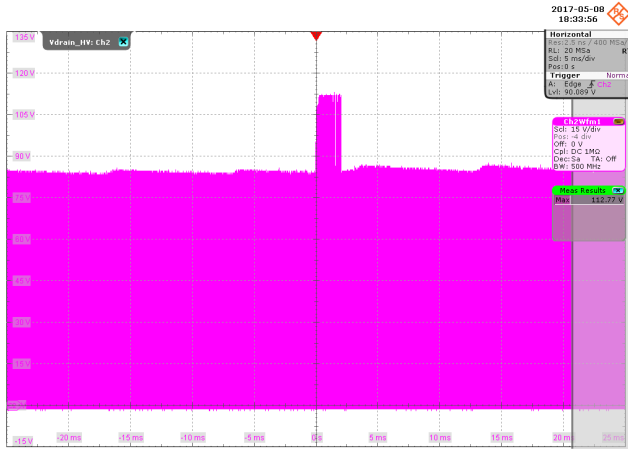
12.1.3.1  $V_{IN} = 85 \text{ VAC}$ , 60 Hz

**Figure 76** – Transient Secondary Drain Voltage,  
 $V_{IN} = 85 \text{ VAC}$ , 60 Hz.  
 Input: 85 VAC, 60 Hz.  
 Output: 5 V, 3 A to 9 V, 3 A.  
 Secondary Drain Voltage: 15 V / div.  
 Time Scale: 5 ms / div.  
 Peak Voltage: 51.1 V.

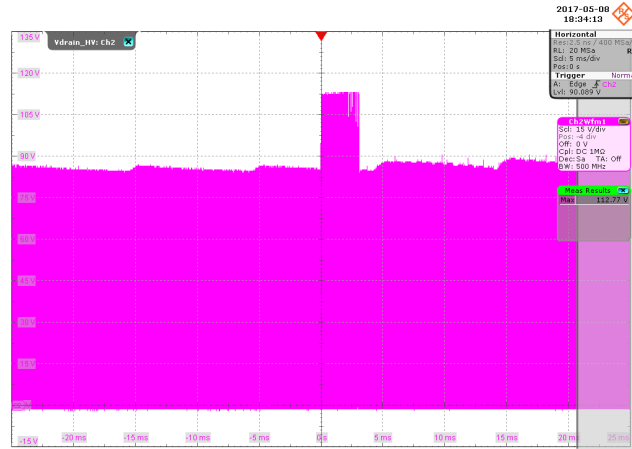


**Figure 77** – Transient Secondary Drain Voltage,  
 $V_{IN} = 85 \text{ VAC}$ , 60 Hz.  
 Input: 85 VAC, 60 Hz.  
 Output: 9 V, 3 A to 15 V, 3 A.  
 Secondary Drain Voltage: 15 V / div.  
 Time Scale: 5 ms / div.  
 Peak Voltage: 65.9 V.

12.1.3.2  $V_{IN} = 265 \text{ VAC}, 50 \text{ Hz}$



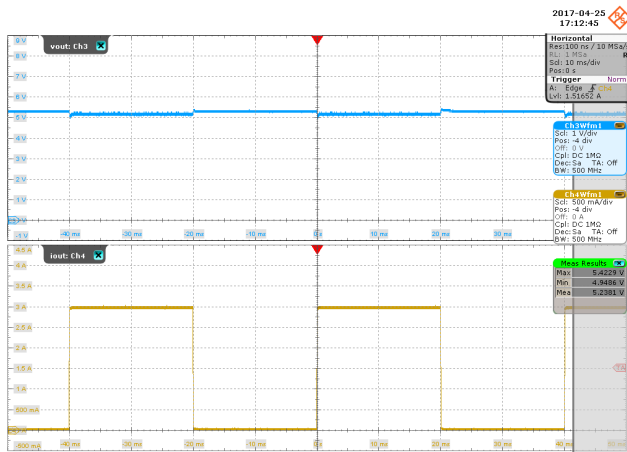
**Figure 78** – Transient Secondary Drain Voltage,  
 $V_{IN} = 265 \text{ VAC}, 50 \text{ Hz}$ .  
 Input: 265 VAC, 50 Hz.  
 Output: 5 V, 3 A to 9 V, 3 A.  
 Secondary Drain Voltage: 15 V / div.  
 Time Scale: 5 ms / div.  
 Peak Voltage: 112.8 V.



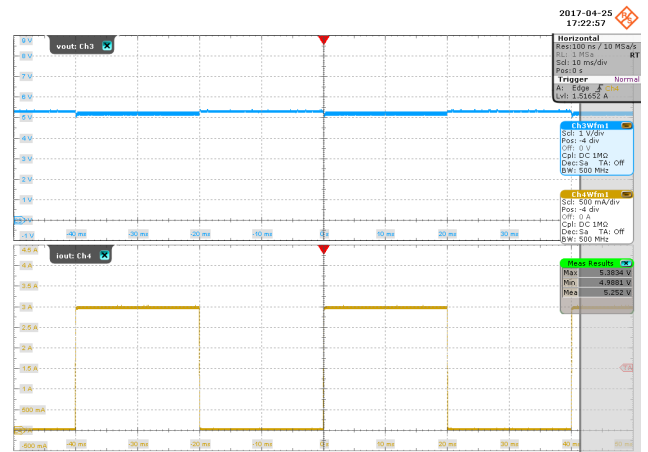
**Figure 79** – Transient Secondary Drain Voltage,  
 $V_{IN} = 265 \text{ VAC}, 50 \text{ Hz}$ .  
 Input: 265 VAC, 50 Hz.  
 Output: 9 V, 3 A to 15 V, 3 A.  
 Secondary Drain Voltage: 15 V / div.  
 Time Scale: 5 ms / div.  
 Peak Voltage: 112.8 V.

12.1.4 Load Transient Response

12.1.4.1  $V_{OUT} = 5 V$

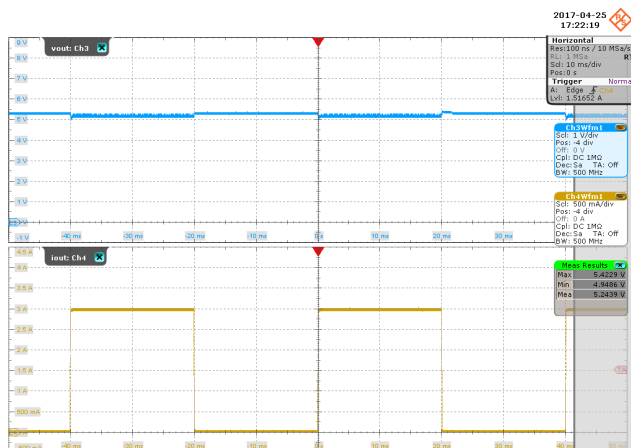


**Figure 80** – Load Transient Response,  $V_{OUT} = 5 V$ .  
 Input: 85 VAC, 60 Hz.  
 Output: 5 V, 3 A.  
 $V_{OUT}$ : 1 V / div;  $I_{OUT}$ : 500 mA / div.  
 Time Scale: 10 ms / div.  
 Max  $V_{OUT}$ : 5.4229 V.  
 Min  $V_{OUT}$ : 4.9486 V.  
 Mean  $V_{OUT}$ : 5.2381 V

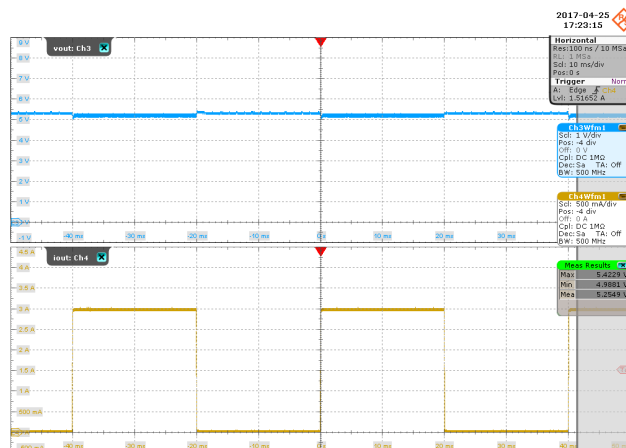


**Figure 81** – Load Transient Response,  $V_{OUT} = 5 V$ .  
 Input: 85 VAC, 60 Hz.  
 Input: 230 VAC, 50 Hz.  
 Output: 5 V, 3 A.  
 $V_{OUT}$ : 1 V / div;  $I_{OUT}$ : 500 mA / div.  
 Time Scale: 10 ms / div.  
 Max  $V_{OUT}$ : 5.3834 V.  
 Min  $V_{OUT}$ : 4.9881 V.  
 Mean  $V_{OUT}$ : 5.252 V.



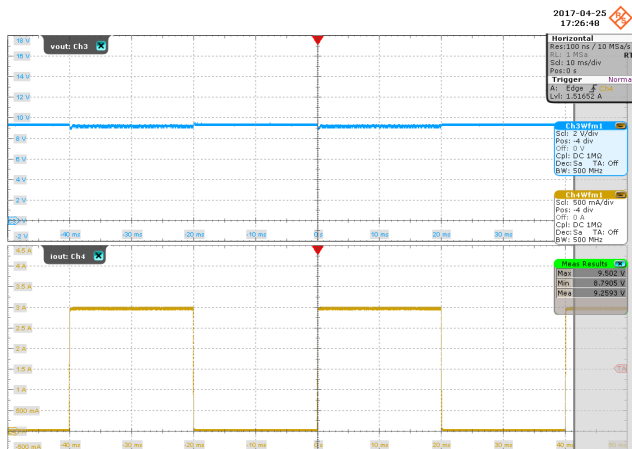


**Figure 82** – Load Transient Response,  $V_{OUT} = 5\text{ V}$ .  
 Input: 115 VAC, 60 Hz.  
 Output: 5 V, 3 A.  
 $V_{OUT}$ : 1 V / div;  $I_{OUT}$ : 500 mA / div.  
 Time Scale: 10 ms / div.  
 Max  $V_{OUT}$ : 5.4229 V.  
 Min  $V_{OUT}$ : 4.9486 V.  
 Mean  $V_{OUT}$ : 5.2439 V.

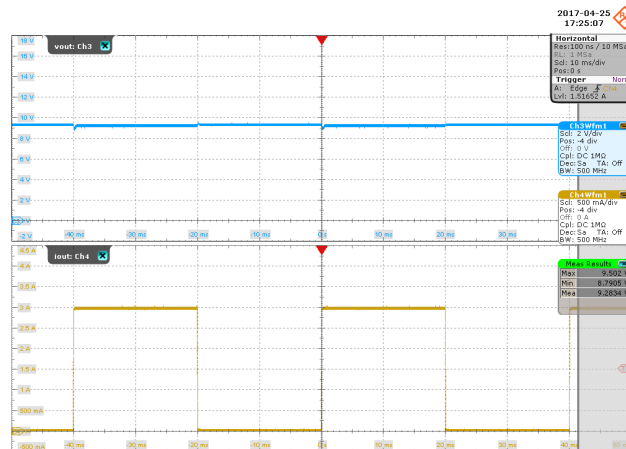


**Figure 83** – Load Transient Response,  $V_{OUT} = 5\text{ V}$ .  
 Input: 265 VAC, 50 Hz.  
 Output: 5 V, 3 A.  
 $V_{OUT}$ : 1 V / div;  $I_{OUT}$ : 500 mA / div.  
 Time Scale: 10 ms / div.  
 Max  $V_{OUT}$ : 5.4229 V.  
 Min  $V_{OUT}$ : 4.9881 V.  
 Mean  $V_{OUT}$ : 5.2549 V.

12.1.4.2  $V_{OUT} = 9\text{ V}$

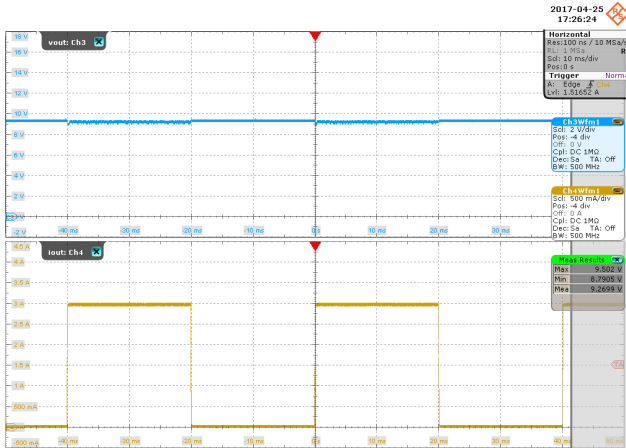


**Figure 84** – Load Transient Response,  $V_{OUT} = 9\text{ V}$ .  
 Input: 85 VAC, 60 Hz.  
 Output: 9 V, 3 A.  
 $V_{OUT}$ : 2 V / div;  $I_{OUT}$ : 500 mA / div.  
 Time Scale: 10 ms / div.  
 Max  $V_{OUT}$ : 9.502 V.  
 Min  $V_{OUT}$ : 8.7905 V.  
 Mean  $V_{OUT}$ : 9.2593 V.

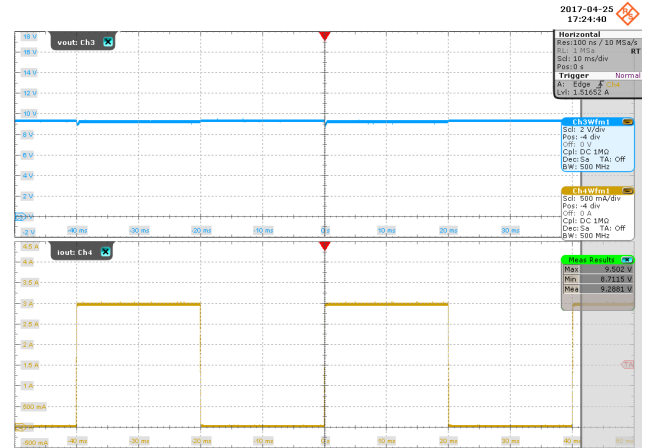


**Figure 85** – Load Transient Response,  $V_{OUT} = 9\text{ V}$ .  
 Input: 230 VAC, 50 Hz.  
 Output: 9 V, 3 A.  
 $V_{OUT}$ : 2 V / div;  $I_{OUT}$ : 500 mA / div.  
 Time Scale: 10 ms / div.  
 Max  $V_{OUT}$ : 9.502 V.  
 Min  $V_{OUT}$ : 8.7905 V.  
 Mean  $V_{OUT}$ : 9.2834 V.





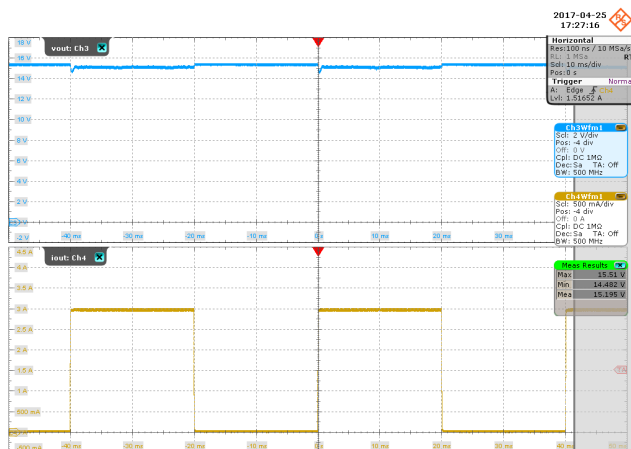
**Figure 86** – Load Transient Response,  $V_{OUT} = 9\text{ V}$ .  
 Input: 115 VAC, 60 Hz.  
 Output: 9 V, 3 A.  
 $V_{OUT}$ : 2 V / div;  $I_{OUT}$ : 500 mA / div.  
 Time Scale: 10 ms / div.  
 Max  $V_{OUT}$ : 9.502 V.  
 Min  $V_{OUT}$ : 8.7905 V.  
 Mean  $V_{OUT}$ : 9.2699 V.



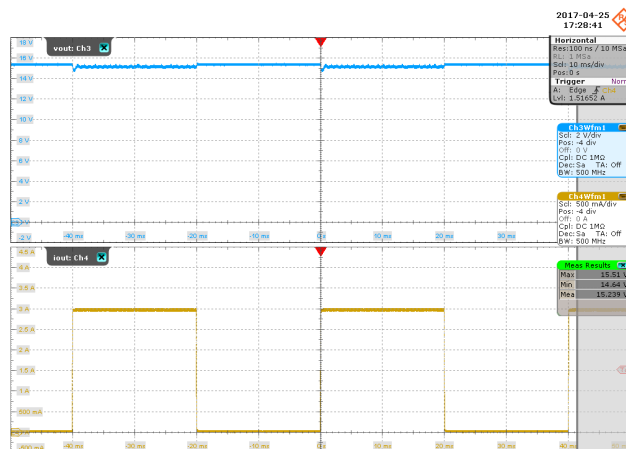
**Figure 87** – Load Transient Response,  $V_{OUT} = 9\text{ V}$ .  
 Input: 265 VAC, 50 Hz.  
 Output: 9 V, 3 A.  
 $V_{OUT}$ : 2 V / div;  $I_{OUT}$ : 500 mA / div.  
 Time Scale: 10 ms / div.  
 Max  $V_{OUT}$ : 9.502 V.  
 Min  $V_{OUT}$ : 8.7115 V.  
 Mean  $V_{OUT}$ : 9.2881 V.



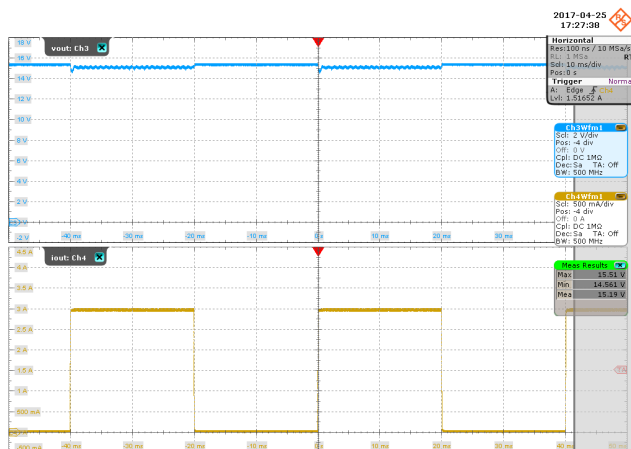
12.1.4.3  $V_{OUT} = 15\text{ V}$



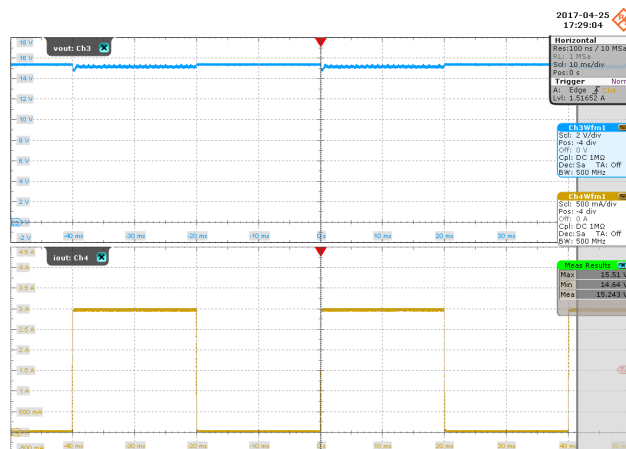
**Figure 88** – Load Transient Response,  $V_{OUT} = 15\text{ V}$ .  
 Input: 85 VAC, 60 Hz.  
 Output: 15 V, 3 A.  
 $V_{OUT}$ : 2 V / div;  $I_{OUT}$ : 500 mA / div.  
 Time Scale: 10 ms / div.  
 Max  $V_{OUT}$ : 15.51 V.  
 Min  $V_{OUT}$ : 14.482 V.  
 Mean  $V_{OUT}$ : 15.195 V.



**Figure 89** – Load Transient Response,  $V_{OUT} = 15\text{ V}$ .  
 Input: 230 VAC, 50 Hz.  
 Output: 15 V, 3 A.  
 $V_{OUT}$ : 2 V / div;  $I_{OUT}$ : 500 mA / div.  
 Time Scale: 10 ms / div.  
 Max  $V_{OUT}$ : 15.51 V.  
 Min  $V_{OUT}$ : 14.64 V.  
 Mean  $V_{OUT}$ : 15.239 V.



**Figure 90** – Load Transient Response,  $V_{OUT} = 15\text{ V}$ .  
 Input: 115 VAC, 60 Hz.  
 Output: 15 V, 3 A.  
 $V_{OUT}$ : 2 V / div;  $I_{OUT}$ : 500 mA / div.  
 Time Scale: 10 ms / div.  
 Max  $V_{OUT}$ : 15.51 V.  
 Min  $V_{OUT}$ : 14.561 V.  
 Mean  $V_{OUT}$ : 15.19 V.

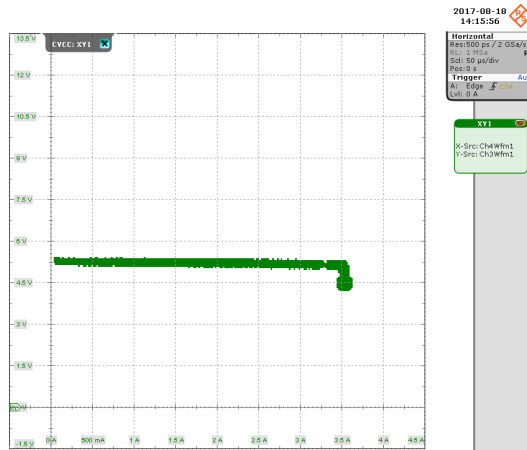


**Figure 91** – Load Transient Response,  $V_{OUT} = 15\text{ V}$ .  
 Input: 265 VAC, 50 Hz.  
 Output: 15 V, 3 A.  
 $V_{OUT}$ : 2 V / div;  $I_{OUT}$ : 500 mA / div.  
 Time Scale: 10 ms / div.  
 Max  $V_{OUT}$ : 15.51 V.  
 Min  $V_{OUT}$ : 14.64 V.  
 Mean  $V_{OUT}$ : 15.243 V.

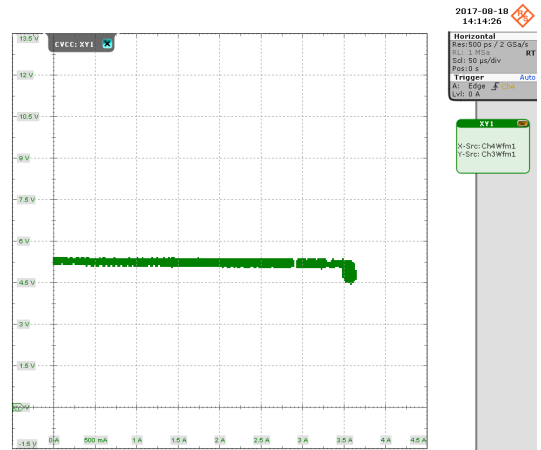


12.1.5 CVCC Profile

12.1.5.1  $V_{OUT} = 5\text{ V}$



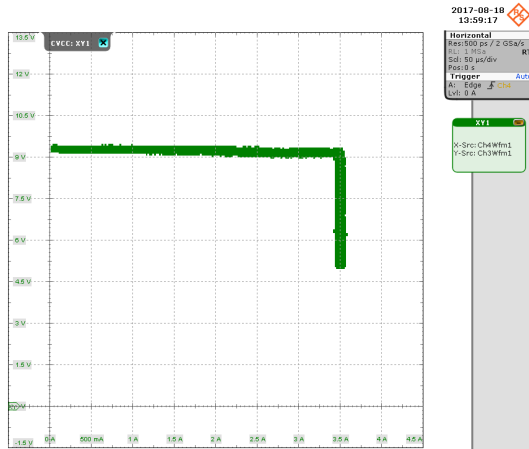
**Figure 92** – CVCC Profile,  $V_{OUT} = 5\text{ V}$ .  
 Input: 85 VAC, 60 Hz.  
 Output: 5 V, 3 A.  
 $V_{OUT}$ : 1.5 V / div.  
 $I_{OUT}$ : 500 mA / div.



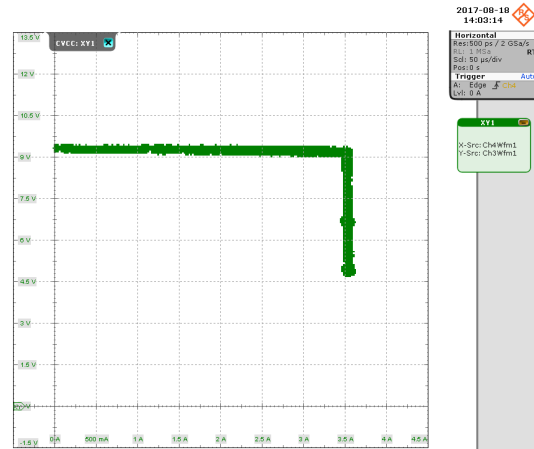
**Figure 93** – CVCC Profile,  $V_{OUT} = 5\text{ V}$ .  
 Input: 265 VAC, 50 Hz.  
 Output: 5 V, 3 A.  
 $V_{OUT}$ : 1.5 V / div.  
 $I_{OUT}$ : 500 mA / div.



12.1.5.2  $V_{OUT} = 9\text{ V}$

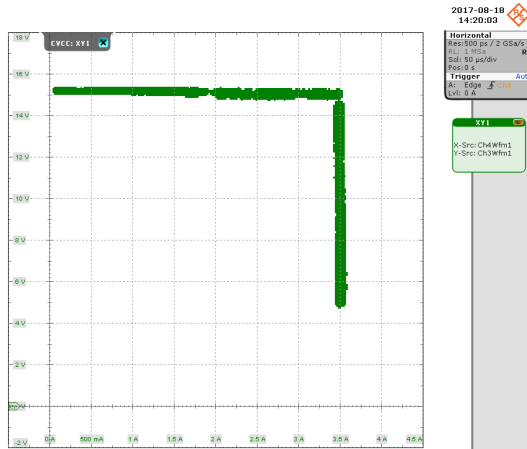


**Figure 94** – CVCC Profile,  $V_{OUT} = 9\text{ V}$ .  
 Input: 85 VAC, 60 Hz.  
 Output: 9 V, 3 A.  
 $V_{OUT}$ : 1.5 V / div.  
 $I_{OUT}$ : 500 mA / div.

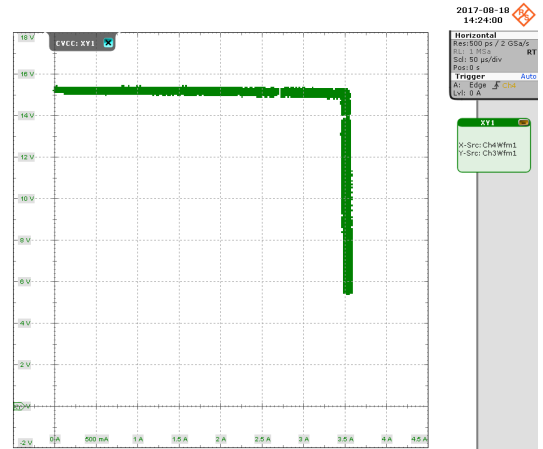


**Figure 95** – CVCC Profile,  $V_{OUT} = 9\text{ V}$ .  
 Input: 265 VAC, 50 Hz.  
 Output: 9 V, 3 A.  
 $V_{OUT}$ : 1.5 V / div.  
 $I_{OUT}$ : 500 mA / div.

12.1.5.3  $V_{OUT} = 15\text{ V}$



**Figure 96** – CVCC Profile,  $V_{OUT} = 15\text{ V}$ .  
 Input: 85 VAC, 60 Hz.  
 Output: 15 V, 3 A.  
 $V_{OUT}$ : 2 V / div.  
 $I_{OUT}$ : 500 mA / div.



**Figure 97** – CVCC Profile,  $V_{OUT} = 15\text{ V}$ .  
 Input: 265 VAC, 50 Hz.  
 Output: 15 V, 3 A.  
 $V_{OUT}$ : 2 V / div.  
 $I_{OUT}$ : 500 mA / div.



### 13 Conducted EMI

#### 13.1 Test Set-up

Parameter	Value
Input Voltage	115 VAC, 230 VAC
Output	15 V, 3 A; 9 V, 3 A; 5 V, 3 A
Enclosure	3D Printed Box
Load	At the End of a 100 mΩ Type-C Cable (Google)

#### 13.2 Test Data

13.2.1 Line = 115 VAC

13.2.1.1  $V_{OUT} = 5 V$

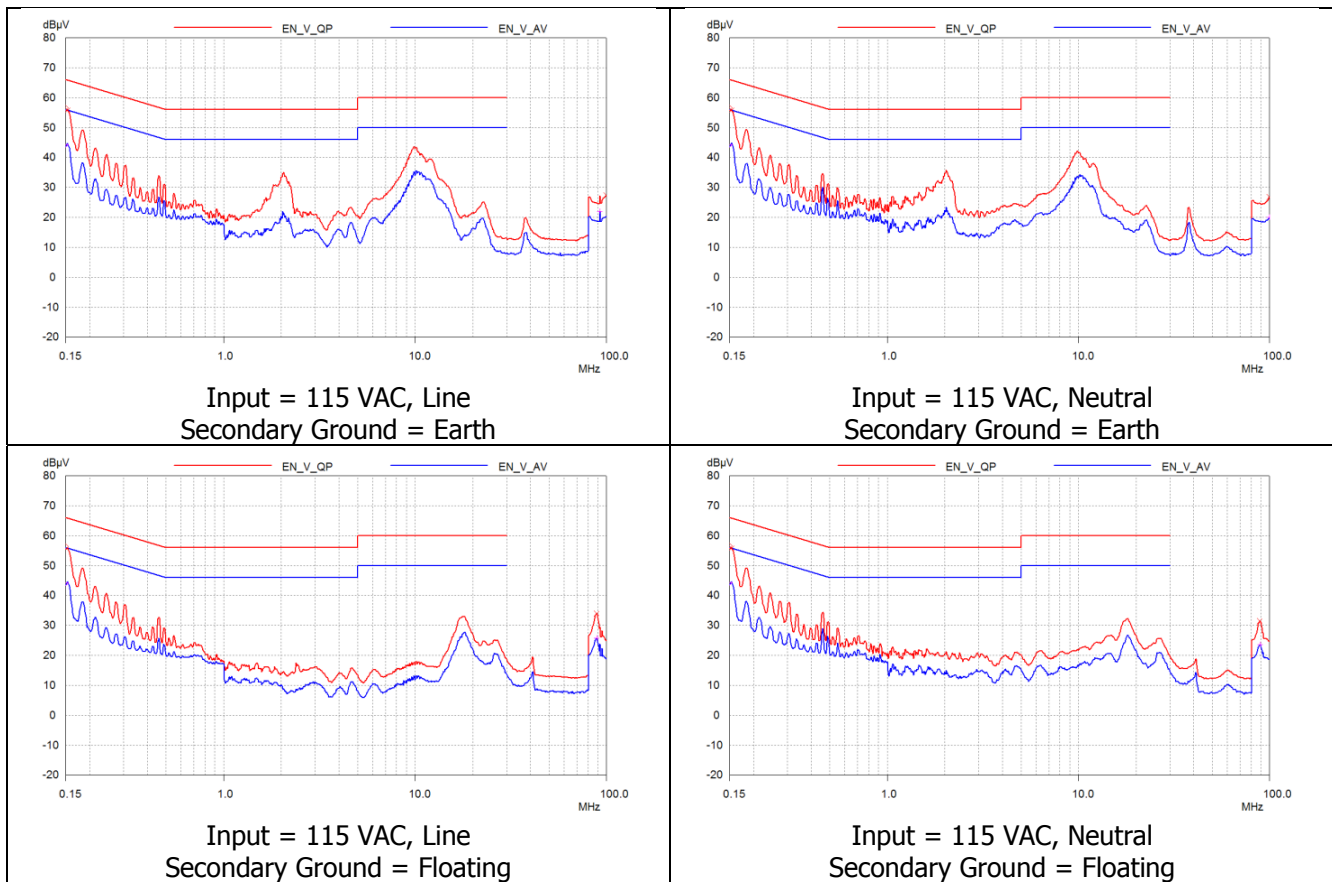


Figure 98 – Conducted EMI,  $V_{OUT} = 5 V$ .

13.2.1.2  $V_{OUT} = 9 V$

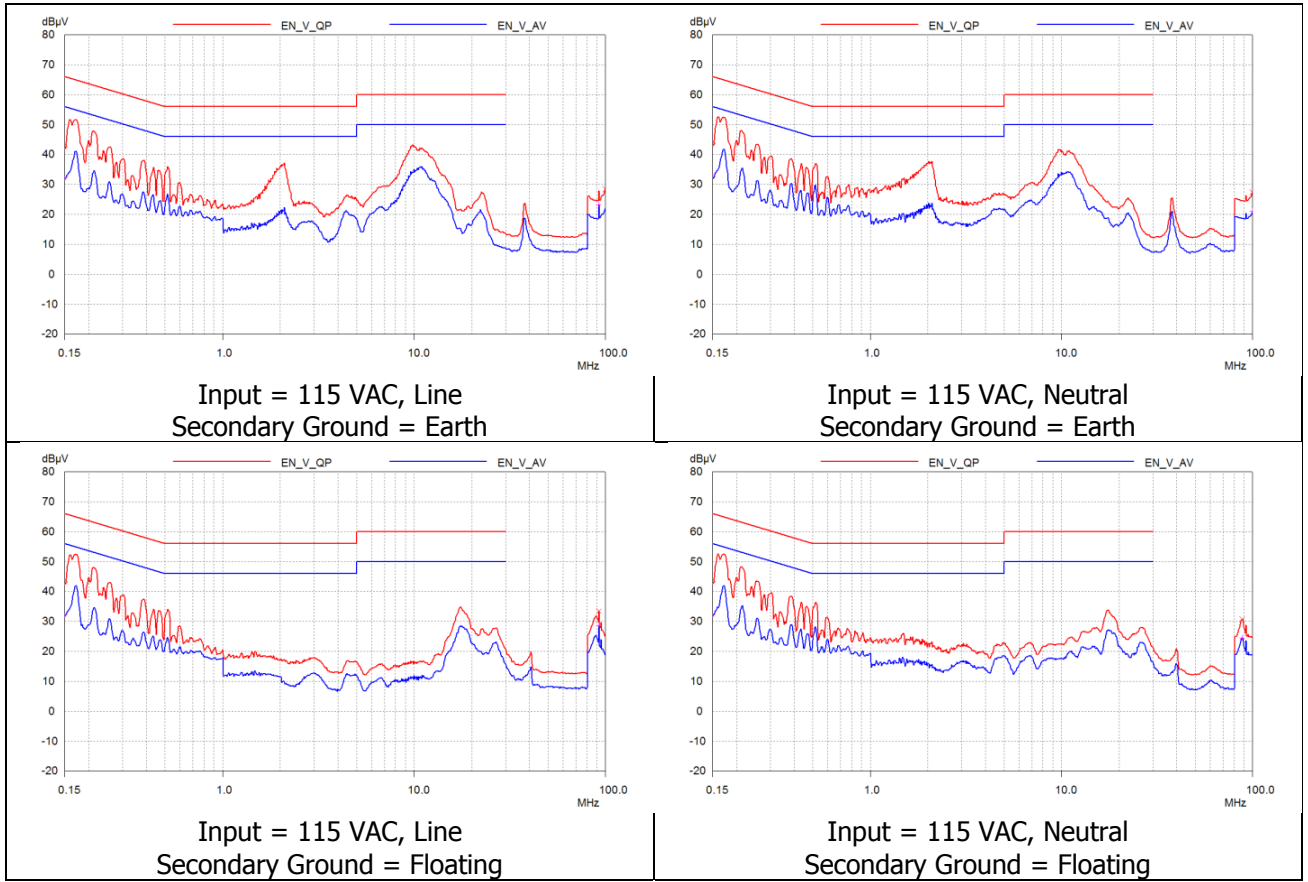


Figure 99 – Conducted EMI,  $V_{OUT} = 9 V$ .



13.2.1.3  $V_{OUT} = 15 V$

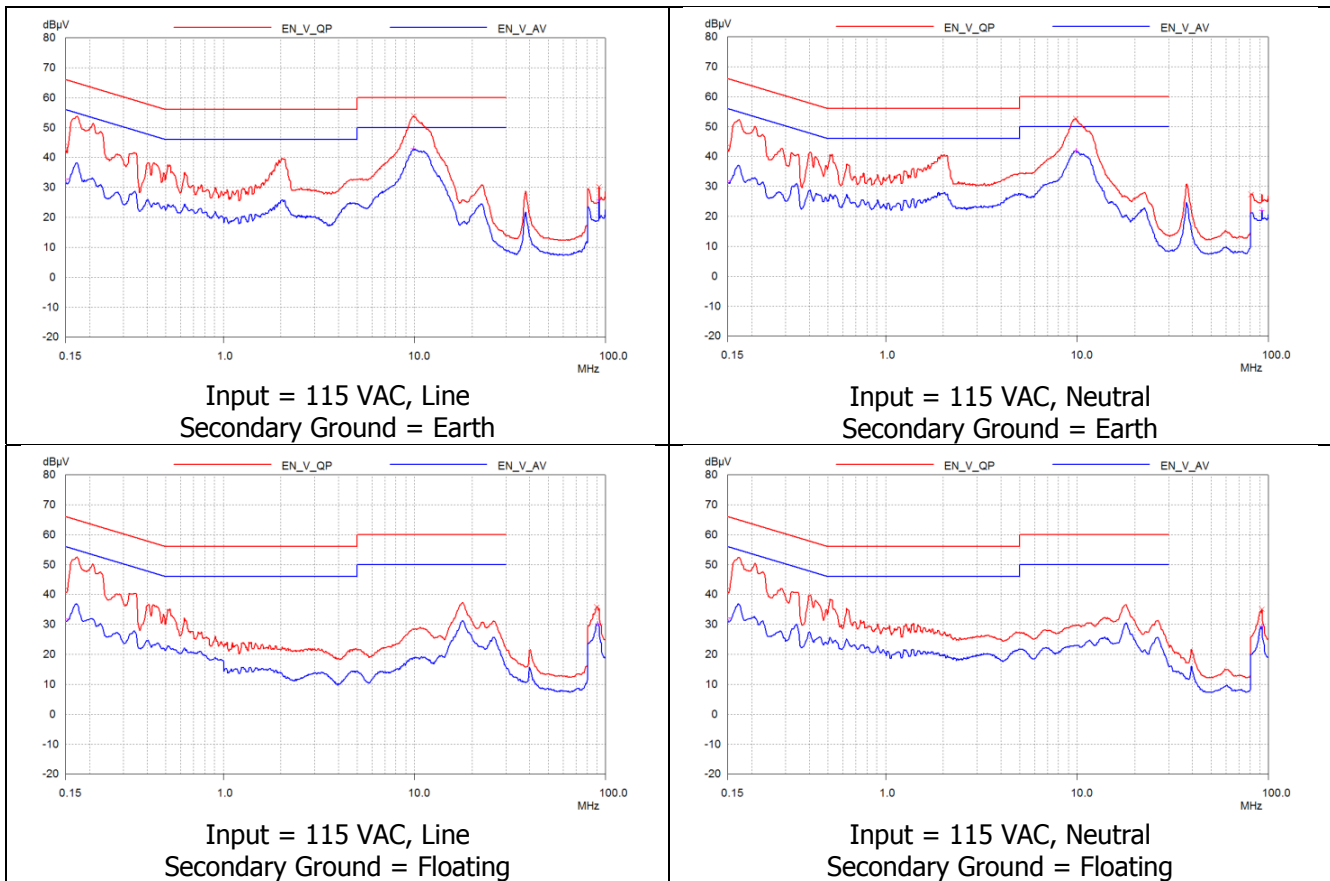


Figure 100 – Conducted EMI,  $V_{OUT} = 15 V$ .

13.2.2 Line = 230 VAC

13.2.2.1  $V_{OUT} = 5 V$

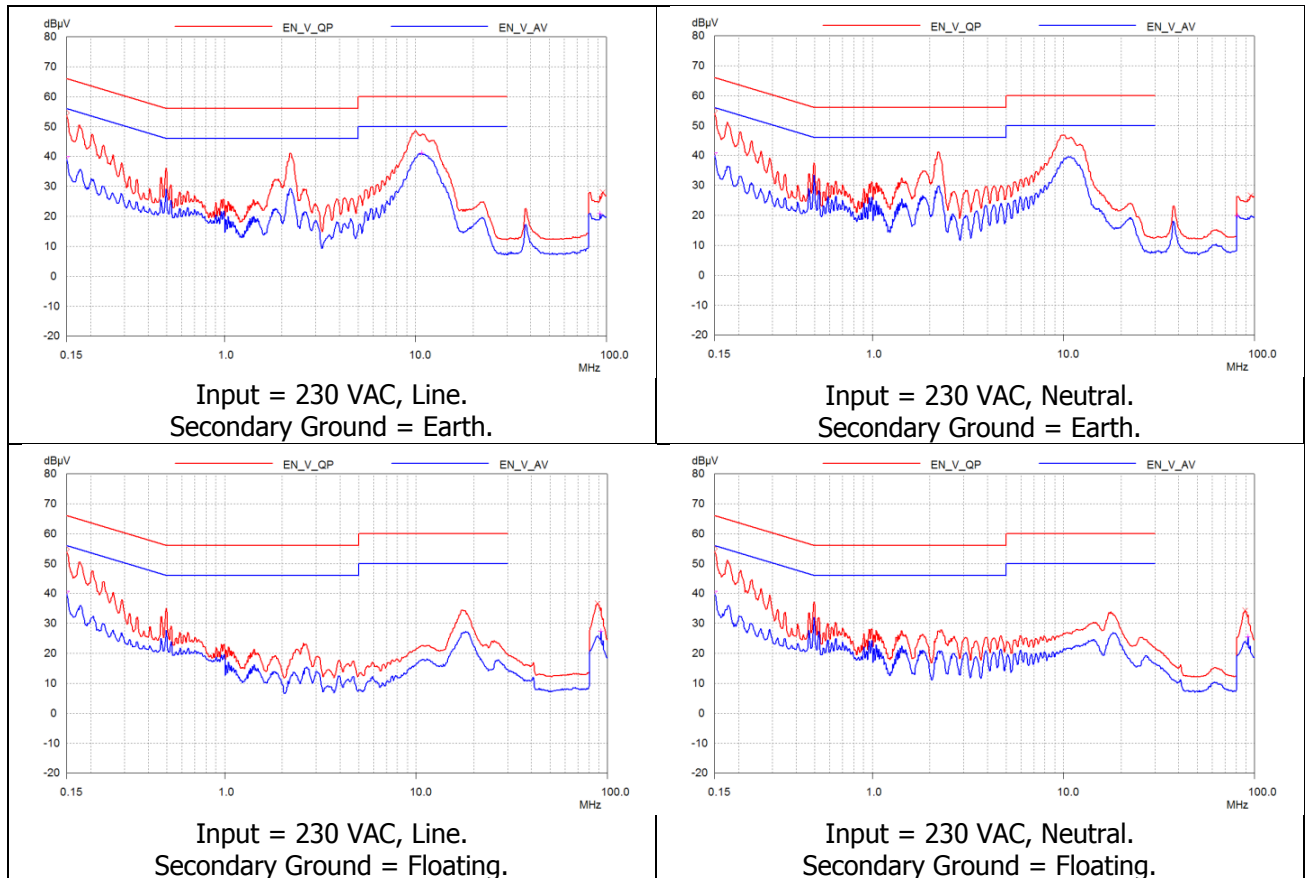


Figure 101 – Conducted EMI,  $V_{OUT} = 5 V$ .

13.2.2.2  $V_{OUT} = 9\text{ V}$

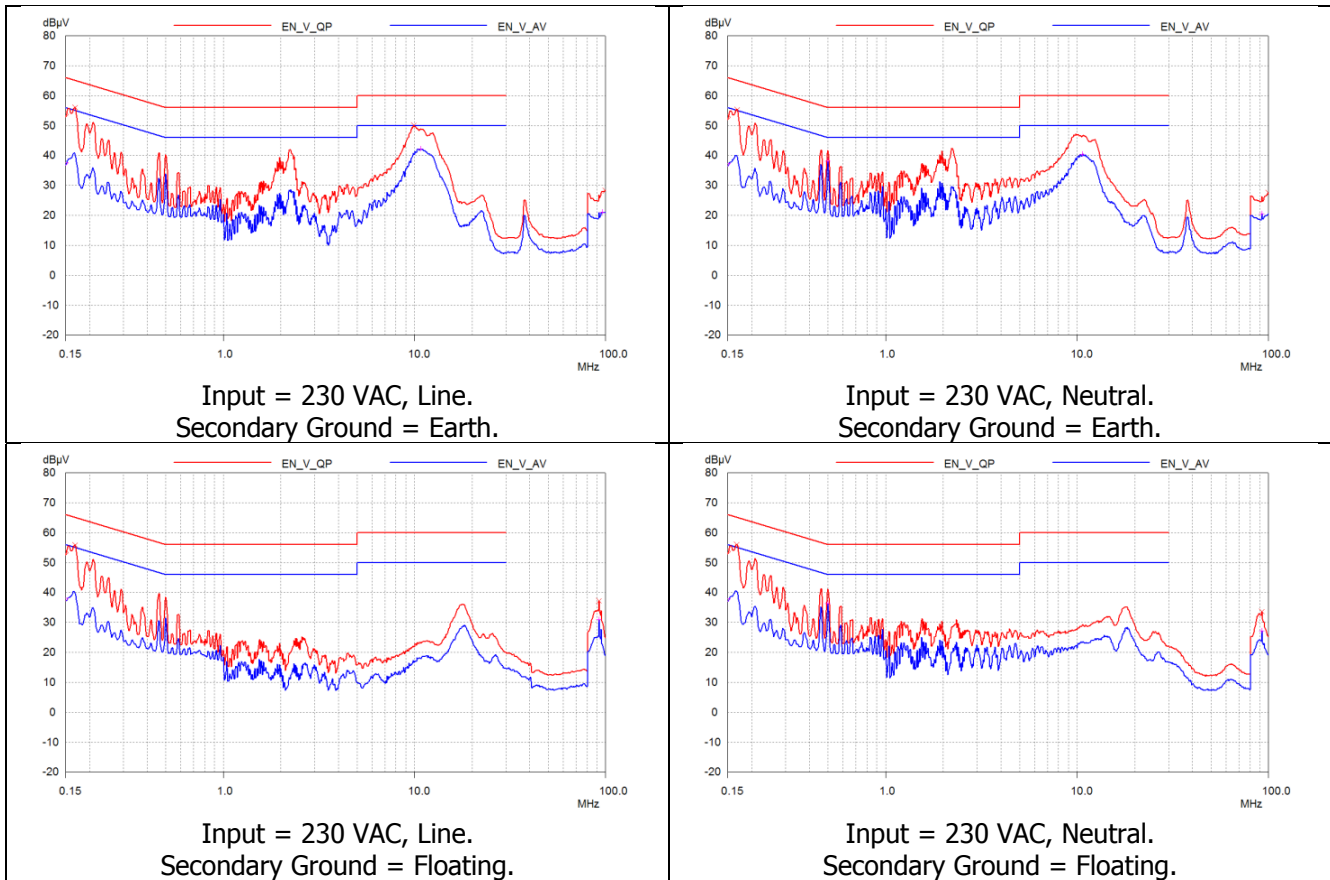


Figure 102 – Conducted EMI,  $V_{OUT} = 9\text{ V}$ .



13.2.2.3  $V_{OUT} = 15 V$

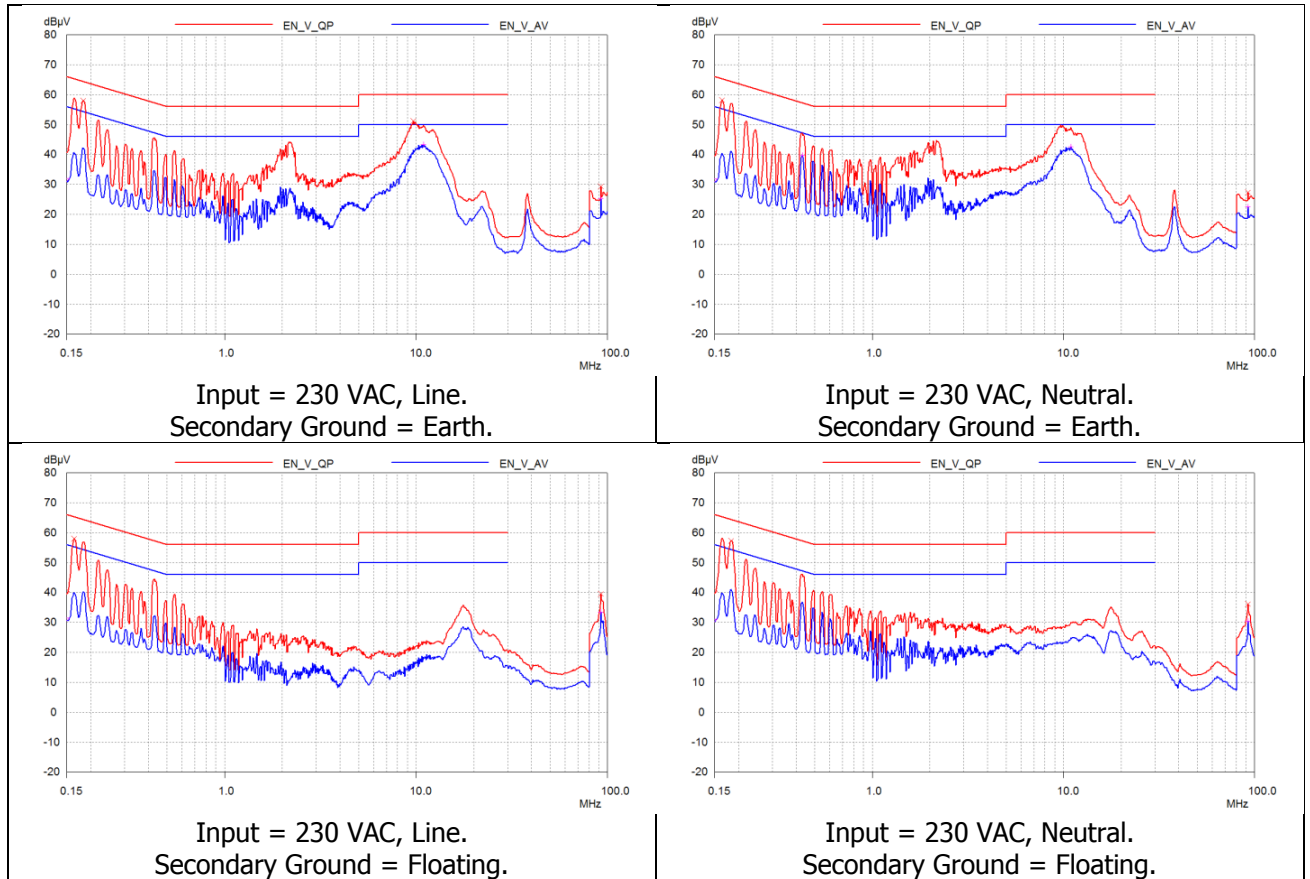


Figure 103 – Conducted EMI,  $V_{OUT} = 15 V$ .



## 14 Surge Testing

### 14.1 Test Set-up

Parameter	Value
Input Voltage	230 VAC
Output	15 V, 3 A
Enclosure	3D Printed Box
Load	At the End of a 100 mΩ Type-C Cable (Google)

### 14.2 Test Data

#### 14.2.1 Combination Wave Differential Surge Test

Coupling: IEC (L -> N)

Impedance: 2Ω

Repetition time: 60s

Step duration: 10 pulses

Voltage (V)	Phase (°)	Load	Strikes	Result
+2500	0	Full Load	10	Pass
-2500	0	Full Load	10	Pass
+2500	90	Full Load	10	Pass
-2500	90	Full Load	10	Pass
+2500	180	Full Load	10	Pass
-2500	180	Full Load	10	Pass
+2500	270	Full Load	10	Pass
-2500	270	Full Load	10	Pass
+2500	0	No-Load	10	Pass
-2500	0	No-Load	10	Pass
+2500	90	No-Load	10	Pass
-2500	90	No-Load	10	Pass
+2500	180	No-Load	10	Pass
-2500	180	No-Load	10	Pass
+2500	270	No-Load	10	Pass
-2500	270	No-Load	10	Pass

Table 4: Combination Wave Differential Surge Test Results.

### 15 Revision History

Date	Author	Revision	Description & Changes	Reviewed
09-Sep-17	ID	1.0	Initial Release	Apps & Mktg



**For the latest updates, visit our website: [www.power.com](http://www.power.com)**

Reference Designs are technical proposals concerning how to use Power Integrations' gate drivers in particular applications and/or with certain power modules. These proposals are "as is" and are not subject to any qualification process. The suitability, implementation and qualification are the sole responsibility of the end user. The statements, technical information and recommendations contained herein are believed to be accurate as of the date hereof. All parameters, numbers, values and other technical data included in the technical information were calculated and determined to our best knowledge in accordance with the relevant technical norms (if any). They may base on assumptions or operational conditions that do not necessarily apply in general. We exclude any representation or warranty, express or implied, in relation to the accuracy or completeness of the statements, technical information and recommendations contained herein. No responsibility is accepted for the accuracy or sufficiency of any of the statements, technical information, recommendations or opinions communicated and any liability for any direct, indirect or consequential loss or damage suffered by any person arising therefrom is expressly disclaimed.

Power Integrations reserves the right to make changes to its products at any time to improve reliability or manufacturability. Power Integrations does not assume any liability arising from the use of any device or circuit described herein. POWER INTEGRATIONS MAKES NO WARRANTY HEREIN AND SPECIFICALLY DISCLAIMS ALL WARRANTIES INCLUDING, WITHOUT LIMITATION, THE IMPLIED WARRANTIES OF MERCHANTABILITY, FITNESS FOR A PARTICULAR PURPOSE, AND NON-INFRINGEMENT OF THIRD PARTY RIGHTS.

**Patent Information**

The products and applications illustrated herein (including transformer construction and circuits' external to the products) may be covered by one or more U.S. and foreign patents, or potentially by pending U.S. and foreign patent applications assigned to Power Integrations. A complete list of Power Integrations' patents may be found at [www.power.com](http://www.power.com). Power Integrations grants its customers a license under certain patent rights as set forth at <http://www.power.com/ip.htm>.

The PI Logo, TOPSwitch, TinySwitch, LinkSwitch, LYTSwitch, InnoSwitch, DPA-Switch, PeakSwitch, CAPZero, SENZero, LinkZero, HiperPFS, HiperTFS, HiperLCS, Qspeed, EcoSmart, Clampless, E-Shield, Filterfuse, FluxLink, StackFET, PI Expert and PI FACTS are trademarks of Power Integrations, Inc. Other trademarks are property of their respective companies. ©Copyright 2015 Power Integrations, Inc.

**Power Integrations Worldwide Sales Support Locations****WORLD HEADQUARTERS**

5245 Hellyer Avenue  
San Jose, CA 95138, USA.  
Main: +1-408-414-9200  
Customer Service:  
Phone: +1-408-414-9665  
Fax: +1-408-414-9765  
e-mail: [usasales@power.com](mailto:usasales@power.com)

**GERMANY**

(IGBT Driver Sales)  
HellwegForum 1  
59469 Ense, Germany  
Tel: +49-2938-64-39990  
Email: [igbt-driver.sales@power.com](mailto:igbt-driver.sales@power.com)

**KOREA**

RM 602, 6FL  
Korea City Air Terminal B/D,  
159-6  
Samsung-Dong, Kangnam-Gu,  
Seoul, 135-728 Korea  
Phone: +82-2-2016-6610  
Fax: +82-2-2016-6630  
e-mail: [koreasales@power.com](mailto:koreasales@power.com)

**CHINA (SHANGHAI)**

Rm 2410, Charity Plaza, No.  
88,  
North Caoxi Road,  
Shanghai, PRC 200030  
Phone: +86-21-6354-6323  
Fax: +86-21-6354-6325  
e-mail:  
[chinasales@power.com](mailto:chinasales@power.com)

**INDIA**

#1, 14<sup>th</sup> Main Road  
Vasanthanagar  
Bangalore-560052  
India  
Phone: +91-80-4113-8020  
Fax: +91-80-4113-8023  
e-mail:  
[indiasales@power.com](mailto:indiasales@power.com)

**SINGAPORE**

51 Newton Road,  
#19-01/05 Goldhill Plaza  
Singapore, 308900  
Phone: +65-6358-2160  
Fax: +65-6358-2015  
e-mail:  
[singaporesales@power.com](mailto:singaporesales@power.com)

**CHINA (SHENZHEN)**

17/F, Hivac Building, No. 2, Keji  
Nan 8th Road, Nanshan District,  
Shenzhen, China, 518057  
Phone: +86-755-8672-8689  
Fax: +86-755-8672-8690  
e-mail: [chinasales@power.com](mailto:chinasales@power.com)

**ITALY**

Via Milanese 20, 3<sup>rd</sup>. Fl.  
20099 Sesto San Giovanni (MI)  
Italy  
Phone: +39-024-550-8701  
Fax: +39-028-928-6009  
e-mail: [eurosales@power.com](mailto:eurosales@power.com)

**TAIWAN**

5F, No. 318, Nei Hu Rd.,  
Sec. 1  
Nei Hu District  
Taipei 11493, Taiwan R.O.C.  
Phone: +886-2-2659-4570  
Fax: +886-2-2659-4550  
e-mail: [taiwansales@power.com](mailto:taiwansales@power.com)

**GERMANY**

(AC-DC/LED Sales)  
Lindwurmstrasse 114  
80337, Munich  
Germany  
Phone: +49-895-527-39110  
Fax: +49-895-527-39200  
e-mail: [eurosales@power.com](mailto:eurosales@power.com)

**JAPAN**

Kosei Dai-3 Building  
2-12-11, Shin-Yokohama,  
Kohoku-ku, Yokohama-shi,  
Kanagawa 222-0033  
Japan  
Phone: +81-45-471-1021  
Fax: +81-45-471-3717  
e-mail: [japansales@power.com](mailto:japansales@power.com)

**UK**

Cambridge Semiconductor,  
a Power Integrations company  
Westbrook Centre, Block 5, 2nd  
Floor  
Milton Road  
Cambridge CB4 1YG  
Phone: +44 (0) 1223-446483  
e-mail: [eurosales@power.com](mailto:eurosales@power.com)



**Power Integrations, Inc.**

Tel: +1 408 414 9200 Fax: +1 408 414 9201  
[www.power.com](http://www.power.com)