

Title	<i>Reference Design Report for a 40 W Power Supply Using InnoSwitch™ 3-Pro INN3377C–H301 and Microchip’s PIC16F18325 Microcontroller</i>
Specification	85 VAC to 265 VAC Input; 3 V to 8 V, 5 A; 8 V to 20 V Constant Power
Application	Programmable Industrial Power Supply
Author	Applications Engineering Department
Document Number	RDR-641
Date	July 28, 2020
Revision	1.9

Summary and Features

- InnoSwitch3-Pro is industry’s first AC/DC IC with isolated, safety rated integrated feedback and I²C interface
- Completely programmable and configurable
 - Controllable output voltage and output current
- Telemetry (read-back) feature with fully configurable protection features
- All the benefits of secondary-side control with the simplicity of primary-side regulation
 - Insensitive to transformer variation
 - Built in synchronous rectification driver for high efficiency
- Easily meets DOE6 and CoC V5 2016 efficiency standards
- <30 mW no-load input power
- Integrated thermal protection
- Primary sensed line overvoltage protection
- 3rd Party Microcontroller – Microchip PIC16F18325

PATENT INFORMATION

The products and applications illustrated herein (including transformer construction and circuits external to the products) may be covered by one or more U.S. and foreign patents, or potentially by pending U.S. and foreign patent applications assigned to Power Integrations. A complete list of Power Integrations' patents may be found at www.powerint.com. Power Integrations grants its customers a license under certain patent rights as set forth at <https://www.power.com/company/intellectual-property-licensing/>.

Power Integrations

5245 Hellyer Avenue, San Jose, CA 95138 USA.
Tel: +1 408 414 9200 Fax: +1 408 414 9201
www.power.com

Table of Contents

1	Introduction	5
2	Power Supply Specification	6
3	Schematic	7
4	Circuit Description	8
4.1	Input EMI Filtering	8
4.2	InnoSwitch3-Pro IC Primary	8
4.3	InnoSwitch3-Pro IC Secondary	8
4.4	Digitally Controlled Feature	10
4.5	Debounce Switches	10
4.6	Headers and Jumpers Settings	10
5	PCB Layout	11
6	Bill of Materials	12
7	Transformer (T2) Specification	14
7.1	Electrical Diagram	14
7.2	Electrical Specifications	14
7.3	Material List	14
7.4	Transformer Build Diagram	15
7.5	Transformer Construction	15
7.6	Winding Illustrations	16
8	Common Mode Choke Specifications	22
8.1	108 μ H Common Mode Choke (L2)	22
8.1.1	Electrical Diagram	22
8.1.2	Electrical Specifications	22
8.1.3	Material List	22
8.1.4	Illustrations	22
8.2	19.8 mH Common Mode Choke (L1)	23
8.2.1	Electrical Diagram	23
8.2.2	Electrical Specifications	23
8.2.3	Materials List	23
8.2.4	Winding Instructions	23
9	Transformer Design Spreadsheet	24
10	Performance Data	28
10.1	Efficiency vs. Load	28
10.1.1	Output: 3 V / 5 A	28
10.1.2	Output: 5 V / 5 A	29
10.1.3	Output: 8 V / 5 A	30
10.1.4	Output: 15 V / 2.666 A	31
10.1.5	Output: 20 V / 2 A	32
10.2	Efficiency vs. Line	33
10.3	Line Regulation	34
10.3.1	Output: 3 V / 5 A	34
10.3.2	Output: 5 V / 5 A	35



10.3.3	Output: 8 V / 5 A	36
10.3.4	Output: 15 V / 2.666 A	37
10.3.5	Output: 20 V / 2 A	38
10.4	Load Regulation	39
10.4.1	Output: 3 V	39
10.4.2	Output: 5 V	40
10.4.3	Output: 8 V	41
10.4.4	Output: 15 V	42
10.4.5	Output: 20 V	43
10.5	No-Load Input Power at 5 V _{OUT}	44
10.6	Average Efficiency	45
10.6.1	Average Efficiency Requirements	45
10.7	Average and 10% Efficiency (On the Board) at 115 VAC Input	45
10.7.1	Output: 3 V	45
10.7.2	Output: 5 V	45
10.7.3	Output: 8 V	45
10.7.4	Output: 15 V	46
10.7.5	Output: 20 V	46
10.8	Average and 10% Efficiency (On the Board) at 230 VAC Input	46
10.8.1	Output: 3 V	46
10.8.2	Output: 5 V	46
10.8.3	Output: 8 V	46
10.8.4	Output: 15 V	47
10.8.5	Output: 20 V	47
10.9	CV/CC	48
10.9.1	Output: 3 V (CC Programmed to 5.1 A, V _{KP} Programmed to 7 V)	48
10.9.2	Output: 5 V (CC Programmed to 5.1 A, V _{KP} Programmed to 7 V)	49
10.9.3	Output: 8 V (CC Programmed to 5.1 A, V _{KP} Programmed to 7 V)	50
10.9.4	Output: 15 V (CC Programmed to 5.1 A, V _{KP} Programmed to 7 V)	51
10.9.5	Output: 20 V (CC Programmed to 5.1 A, V _{KP} Programmed to 7 V)	52
11	Thermal Performance in Open Case	53
11.1	85 VAC Input 3 V / 5 A	53
11.2	265 VAC Input 3 V / 5 A	53
11.3	85 VAC Input 5 V / 5 A	54
11.4	265 VAC Input 5 V / 5 A	54
11.5	85 VAC Input 8 V / 5 A	55
11.6	265 VAC Input 8 V / 5 A	55
11.7	85 VAC Input 15 V / 2.666 A	56
11.8	265 VAC Input 15 V / 2.666 A	56
11.9	85 VAC Input 20 V / 2 A	57
11.10	265 VAC Input 20 V / 2 A	57
12	Waveforms	58
12.1	Load Transient Response (PCB End)	58

12.2	Switching Waveforms.....	61
12.2.1	Drain Voltage and Current	61
12.2.2	Drain Voltage and Current Start-up	63
12.2.3	SR FET Voltage	64
12.2.4	Output Voltage and Current Start-up (On the Board).....	67
12.3	Output Ripple Measurements.....	68
12.3.1	Ripple Measurement Technique	68
12.3.2	Ripple Amplitude vs. Line	69
13	Conducted EMI	72
13.1	Floating Output	72
13.1.1	Output: 8 V / 5 A	72
13.1.2	Output: 20 V / 2 A	74
13.2	Artificial Hand.....	76
13.2.1	Output: 8 V / 5 A	76
13.2.2	Output: 20 V / 2 A	78
13.3	Earth Ground.....	80
13.3.1	Output: 8 V / 5 A	80
13.3.2	Output: 20 V / 2 A	82
14	Line Surge.....	84
14.1	Differential Surge.....	84
14.2	Common Mode Surge.....	84
15	Revision History	85

Important Note:

Although this board is designed to satisfy safety isolation requirements, the engineering prototype has not been agency approved. Therefore, all testing should be performed using an isolation transformer to provide the AC input to the prototype board.



1 Introduction

This document is an engineering report describing a 5 A CV/CC charger (3 V to 8 V range), which switches to constant power in the 8 V to 20 V range using the InnoSwitch3-Pro and Microchip's PIC16F18325 microcontroller. PIC16F18325 controls the InnoSwitch3-Pro via an I²C interface, programming its COMMAND and telemetry registers. This design shows the high power density and efficiency that is possible from the high level of integration in the InnoSwitch3-Pro controller. The report contains the power supply specification, schematic, bill of materials, transformer documentation, printed circuit layout, and performance data.



Figure 1 – Populated Circuit Board Photograph, Top.
(DER-641 is equivalent to RD-641.)

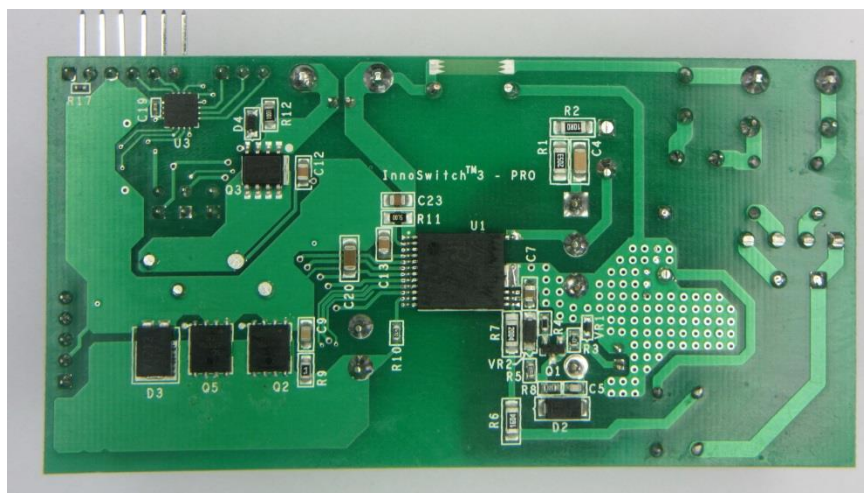

Figure 2 – Populated Circuit Board Photograph, Bottom.

2 Power Supply Specification

The table below represents the minimum acceptable performance for the design. Actual performance is listed in the results section.

Description	Symbol	Min	Typ	Max	Units	Comment
Input						
Voltage	V_{IN}	85		265	VAC	2 Wire – no P.E.
Frequency	f_{LINE}	47	50/60	64	Hz	
No-load Input Power (230 VAC)			36	40	mW	Measured at 230 VAC.
3 V – 20 V Output						
Output Voltage	V_{OUT}	3	5	20	V	±3%
Output Ripple Voltage	V_{RIPPLE}			150	mV	At End of 100 mΩ Cable.
Output Current	I_{OUT}			5.0	A	20 MHz Bandwidth.
Continuous Output Power	P_{OUT}			40	W	
Conducted EMI						
Safety						Meets CISPR22B / EN55022B Designed to meet IEC60950 / UL1950 Class II
Ambient Temperature	T_{AMB}	0		40	°C	Free Convection, Sea Level.

Note: To use this design for a charger/adaptor, the circuit board may need to be modified to match the shape and form factor of the housing. ESD and line surge performance would need to be evaluated and layout adjusted as appropriate for the revised design.

4 Circuit Description

4.1 Input EMI Filtering

Fuse F1 isolates the circuit and provides protection from component failure. The common mode choke L2 along with capacitors C1 and C8 provides EMI attenuation. Bridge rectifier BR1 rectifies the AC line voltage and provides a full wave rectified DC to a π filter made up of C2, L1, and C3. This filter provides differential and common mode noise filtering. Thermistor RT1 limits the inrush current when the power supply is connected to the input AC supply.

4.2 InnoSwitch3-Pro IC Primary

One end of the transformer primary winding is connected to the rectified DC bus, the other to the drain terminal of the InnoSwitch3-Pro IC MOSFET (U1). Resistors R6 and R7 provide sense input line voltage and used undervoltage and overvoltage protection via the V pin of U1.

A simple RCD clamp formed by diode D1, resistors R1 and R2, and capacitor C4 limits the peak drain-source voltage of U1 at the instant the MOSFET inside U1 turns off. The clamp helps dissipate the energy stored in the leakage reactance of transformer T1.

The IC is self-starting, using an internal high-voltage current source to charge the BPP pin capacitor (C7) when AC is first applied. During normal operation the primary side block is powered from an auxiliary winding on the transformer T1. Output of the auxiliary (or bias) winding is rectified using diode D2 and filtered by capacitor C6. Resistor R4 limits the current being supplied to the BPP pin. A linear regulator comprising resistor R3, BJT Q1 and Zener diode VR1 prevents any change in current through R4. An RC network comprising resistor R8 and capacitor C5 damp the high frequency voltage ring across diode D2. This reduces radiated EMI.

Zener diode VR2 offers primary sensed output overvoltage protection. In a flyback converter, output of the auxiliary winding tracks the output voltage of the converter. In case of over voltage at output of the converter, the auxiliary winding voltage increases and causes breakdown of VR2 which then causes a current to flow into the BPP pin of InnoSwitch3-Pro IC U1. If the current flowing into the BPP pin increases above the I_{SD} threshold, the InnoSwitch3-Pro controller will latch off and prevent any further increase in output voltage. Resistor R5 limits the current injected to BPP pin.

4.3 InnoSwitch3-Pro IC Secondary

The secondary-side of the InnoSwitch3-Pro IC provides output voltage, output current sensing and drive to a MOSFET providing synchronous rectification. The secondary of the transformer is rectified by MOSFETs Q2 and Q5 and filtered by capacitors C10 and C11.



High frequency ringing during switching transients that would otherwise create radiated EMI is reduced via a RC snubber, R9 and C9.

The gate of Q2 and Q5 are turned on by secondary-side controller inside IC U1, based on the secondary winding voltage sensed via resistor R10 and fed into the FWD pin of the IC. Current sharing of the two FETs Q2 and Q5 are obtained by adding the resistors R25 and R26 in series with the gates of the respective FETs.

In continuous conduction mode of operation, the MOSFET is turned off just prior to the secondary-side commanding a new switching cycle from the primary. In discontinuous mode of operation, the power MOSFET is turned off when the voltage drop across the MOSFET falls below a threshold of approximately $V_{SR(TH)}$. Secondary-side control of the primary-side power MOSFET avoids any possibility of cross conduction of the two MOSFETs and provides extremely reliable synchronous rectification.

The secondary-side of the IC is self-powered from either the secondary winding forward voltage or the output voltage. Capacitor C13 connected to the BPS pin of InnoSwitch3-Pro IC U1 provides decoupling for the internal circuitry.

During CC operation, when the output voltage falls, the device will power itself from the secondary winding directly. During the on-time of the primary-side power MOSFET, the forward voltage that appears across the secondary winding is used to charge the SECONDARY BYPASS pin decoupling capacitor C13 via resistor R10 and an internal regulator. This allows output current regulation to be maintained down to 3.0 V. Below this level the unit enters auto-restart until the output load is reduced. Capacitor C12 is needed between the VOUT pin and the SECONDARY GROUND pin for ESD protection of the VOUT pin.

Output current is sensed by monitoring the voltage drop across resistor R11 between the IS and SECONDARY GROUND pins. A threshold of approximately 32 mV reduces losses. A decoupling capacitor C23 is needed between the IS and SECONDARY GROUND pin to improve CC accuracy. Once the internal current sense threshold is exceeded, the device regulates the number of switch pulses to maintain a fixed output current. When the output current is below the CC threshold, the device operates in constant voltage mode. The output voltage is set by the I²C interface.

N-MOSFET Q3 forms the bus switch and is controlled by the VB/D pin on the InnoSwitch3-Pro IC. Resistor R12 and diode D4 are needed from the Source of the MOSFET to its gate for providing a voltage discharge path when the bus switch is opened. Capacitor C21 is needed at the output for ESD protection.

4.4 Digitally Controlled Feature

In this design, PIC16F18325 is the I²C Master and InnoSwitch3-Pro is the Slave device. The output of the InnoSwitch3-Pro powers the MCU directly to its μ VCC output pin.

The PIC microcontroller communicates over its I²C lines to the SDA and SCL pins (which are both 3.3 V and 5 V compatible) of the InnoSwitch3-Pro IC. The SDA and SCL lines need pull-up resistors R24 and R23 respectively to the μ VCC pin. The μ VCC pin needs a decoupling capacitor C20.

The MCU enables dynamic control of output voltage and current along with many configurable features through I²C communication. I²C Communication is set to 400 kHz on this design.

4.5 Debounce Switches

Two debounce switches are present on the board. When Idle, the switches are pulled high (+3.3 V). When pressed, they are grounded. On each button press I²C commands are generated to do the following below.

Switch 1 (SW1) Functions:

Single Click	1 V Increment
Double Click	1 V Decrement

Switch 2 (SW2) Functions:

Single Click	200 mv Increment
Double Click	200 mv Decrement

4.6 Headers and Jumpers Settings

The table provides the description for each jumper available on the board.

Jumper	Description	Settings
J3	μ VCC and MCU Supply Jumper	If connected the μ VCC output pin of the InnoSwitch3-Pro will provide power to the on board microcontroller.
J6 J7	I ² C Lines Isolation Jumper	The user can select whether or not the SDA and SCL lines from the MCU will be connected to the InnoSwitch3-Pro.

The following headers are also available on the board.

Header	Description	Settings
J4	InnoSwitch3-Pro I ² C Lines Header	When J6 and J7 are removed, an external I ² C master can be connected through this header.
J5	PICkit3 Programming Header	For MCU firmware update using PICkit3 in-Circuit debugger/programmer.
J8	MCU GPIO Header	This can be used as debug pins

5 PCB Layout

PCB copper thickness is 2.0 oz.

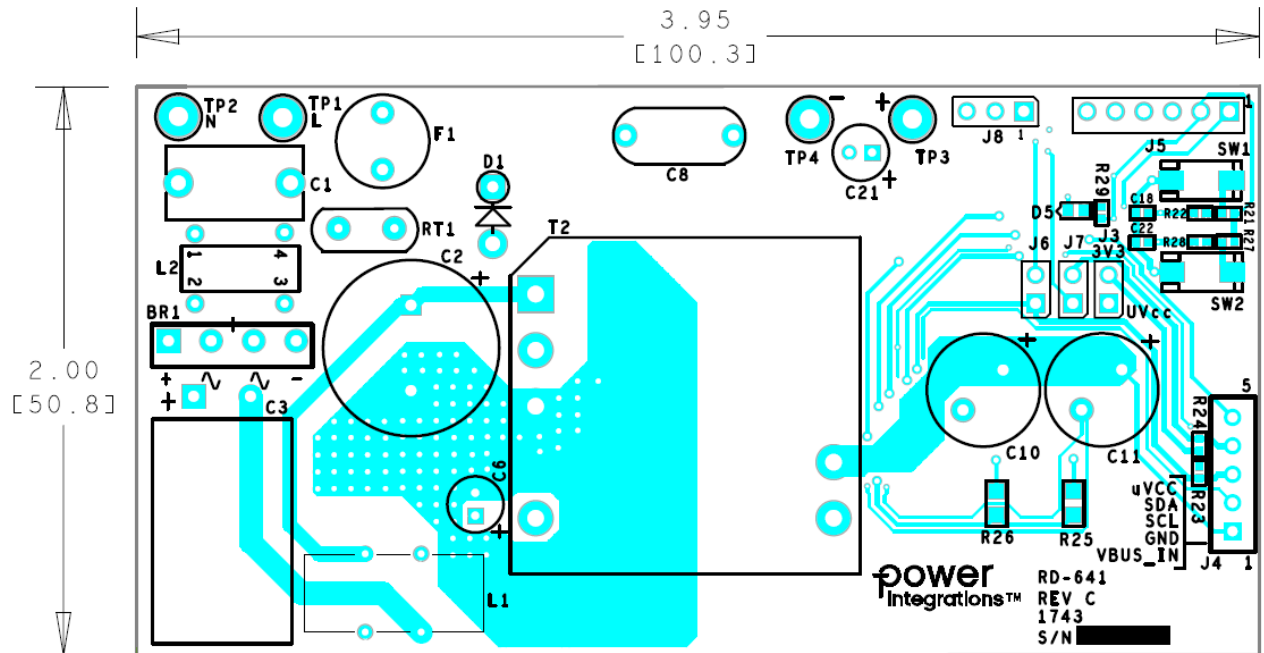

Figure 4 – Printed Circuit Layout, Top.

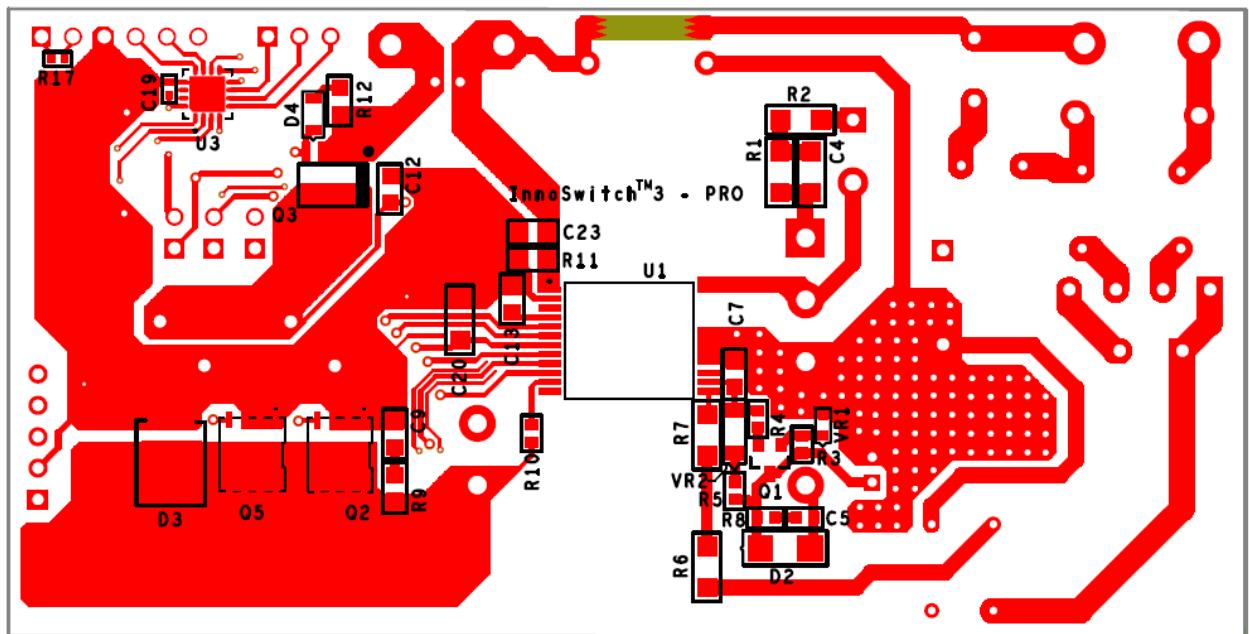

Figure 5 – Printed Circuit Layout, Bottom.

6 Bill of Materials

Item	Qty	Ref Des	Description	Mfg Part Number	Mfg
1	1	BR1	Bridge Rectifier, 1000 V, 4 A, 4-ESIP, D3K, -55°C ~ 150°C (TJ), Vf = 1 V @ 7.5 A	UD4KB100-BP	Micro Commercial
2	1	C1	100 nF, 275 VAC, Film, X2	R46KF310000P1M	Kemet
3	1	C2	68 µF, 400 V, Electrolytic, (16 x 25)	UCY2G680MHD9TN	Nichicon
4	1	C3	33 µF, 400 V, Electrolytic, (12.5 x 20)	KMG401ELL330MK20S 860021378014	Nippon Chemi-Con Würth
5	1	C4	2.2 nF, 630 V, Ceramic, X7R, 1206	C3216X7R2J222K115AA	TDK
6	1	C5	56 pF, 250 V, Ceramic, NPO, 0603	GQM1875C2E560JB12D	Murata
7	1	C6	22 µF, 50 V, Electrolytic, (5 x 11)	UPW1H220MDD	Nichicon
8	1	C7	4.7 µF, 50 V, Ceramic, X5R, 0805	CL21A475KBQNNNE	Samsung
9	1	C8	680 pF, Ceramic, Y1	440LT68-R	Vishay
10	1	C9	1 nF, 200 V, Ceramic, X7R, 0805	08052C102KAT2A	AVX
11	1	C10	470 µF, 25 V, ±20%, Al Organic Polymer, Gen. Purpose, Can, 15 mΩ, 2000 Hrs @ 105°C	A750MS477M1EAAE015	KEMET
12	1	C11	470 µF, 25 V, ±20%, Al Organic Polymer, Gen. Purpose, Can, 15 mΩ, 2000 Hrs @ 105°C	A750MS477M1EAAE015	KEMET
13	1	C12	2.2 µF, ±10%, 25 V, Ceramic, X7R, 0805, -55 to 125 °C	C2012X7R1E225M	TDK
14	1	C13	2.2 µF, 25 V, Ceramic, X7R, 0805	C2012X7R1E225M	TDK
15	1	C18	1 nF 100 V, Ceramic, X7R, 0402	GCM155R72A102KA37D	Murata
16	1	C19	100 nF 16 V, Ceramic, X7R, 0402	L05B104KO5NNNC	Samsung
17	1	C20	2.2 µF, 25 V, Ceramic, X7R, 0805	C2012X7R1E225M	TDK
18	1	C21	10 µF, 50 V, Electrolytic, Gen Purpose, (5 x 11)	ECA-1HHG100	Panasonic
19	1	C22	1 nF 100 V, Ceramic, X7R, 0402	GCM155R72A102KA37D	Murata
20	1	C23	1 µF, ±20%, 50 V, Ceramic, X7R, Boardflex Sensitive, 0805	CGA4J3X7R1H105M125AE	TDK
21	1	D1	1000 V, 1 A, Fast Recovery Diode, GP DO-41	FR107G-B	Rectron
22	1	D2	200 V, 1 A, Fast Recovery, 150 ns, SMA	RS1D-13-F	Diodes, Inc.
23	1	D3	Diode, Schottky, 120V, 12A, Surface Mount, TO-277A (SMPC)	V12P12-M3/86A	Vishay
24	1	D4	75 V, 0.15 A, Switching, SOD-323	BAV16WS-7-F	Diodes, Inc.
25	1	D5	LED, GREEN, 525nm, 3.2V, 20mA, 260.5mcd, RECT, CLEAR, 0603	LTST-C194TGKT	Lite-On
26	1	F1	4 A, 250V, Fast, TR5	37014000410	Wickman
27	1	J3	2 Position (1 x 2) header, 0.1 pitch, Vertical	22-03-2021	Molex
28	1	J4	5 Position (1 x 5) Female header, 0.1 pitch, 00.126" (3.20mm), Vertical, Au	PPPC051LFBN-RC	Sullins
29	1	J5	6 Position (1 x 6) header, 0.1 pitch, R/A Tin	22-05-2061	Molex
30	1	J6	2 Position (1 x 2) header, 0.1 pitch, Vertical	22-03-2021	Molex
31	1	J7	2 Position (1 x 2) header, 0.1 pitch, Vertical	22-03-2021	Molex
32	1	J8	3 Position (1 x 3) header, 0.1 pitch, Vertical	22-28-4030	Molex
33	1	L1	19.8 mH, Toroidal Common Mode Choke, custom, wound on 32-00286-00 core (14.90 mm O.D. 6.5 mm Th 7.0 mm ID)	32-00463-00 TSD-4191	Power Integrations Premier Magnetics
34	1	L2	Custom, 108 µH, constructed on Core 35T0375-10H from PI# 30-00275-00	TSD-3761	Power Integrations Premier Magnetics
35	1	Q1	NPN, Small Signal BJT, 80 V, 0.5 A, SOT-23	MMBTA06LT1G	On Semi
36	1	Q2	MOSFET, N-Channel, 100 V, 46 A (Tc), 83 W (Tc), Surface Mount, 8PDFN (5x6)	TSM160N10LCR RLG	Taiwan Semi
37	1	Q3	MOSFET, N-CH, 60 V, 12 A, 8SOIC	AO4264 AO4354	Alpha & Omega Semi
38	1	Q5	MOSFET, N-Channel, 100 V, 46 A (Tc), 83 W (Tc), Surface Mount, 8PDFN (5x6)	TSM160N10LCR RLG	Taiwan Semi
39	1	R1	RES, 205 kΩ, 1%, 1/4 W, Thick Film, 1206	ERJ-8ENF2053V	Panasonic
40	1	R2	RES, 10 Ω, 1%, 1/4 W, Thick Film, 1206	ERJ-8ENF10R0V	Panasonic
41	1	R3	RES, 100 kΩ, 5%, 1/10 W, Thick Film, 0603	ERJ-3GEYJ104V	Panasonic
42	1	R4	RES, 3.01 kΩ, 1%, 1/16 W, Thick Film, 0603	ERJ-3EKF3011V	Panasonic



43	1	R5	RES, 22 Ω , 5%, 1/10 W, Thick Film, 0603	ERJ-3GEYJ220V	Panasonic
44	1	R6	RES, 1.60 M Ω , 1%, 1/4 W, Thick Film, 1206	ERJ-8ENF1604V	Panasonic
45	1	R7	RES, 2.00 M Ω , 1%, 1/4 W, Thick Film, 1206	ERJ-8ENF2004V	Panasonic
46	1	R8	RES, 22 Ω , 5%, 1/10 W, Thick Film, 0603	ERJ-3GEYJ220V	Panasonic
47	1	R9	RES, 5.6 Ω , 5%, 1/8 W, Thick Film, 0805	ERJ-6GEYJ5R6V	Panasonic
48	1	R10	RES, 47 Ω , 5%, 1/10 W, Thick Film, 0603	ERJ-3GEYJ470V	Panasonic
49	1	R11	RES, 0.005 Ω , 0.5 W, 1%, 0805	PMR10EZPFU5L00	Rohm
50	1	R12	RES, 1.00 k Ω , 1%, 1/8 W, Thick Film, 0805	ERJ-6ENF1001V	Panasonic
51	1	R17	RES, 10 k Ω , 5%, 1/16 W, Thick Film, 0402	RC0402JR-0710KL	Yageo
52	1	R21	RES, 10 k Ω , 5%, 1/16 W, Thick Film, 0402	RC0402JR-0710KL	Yageo
53	1	R22	RES, 470 Ω , 5%, 1/10 W, Thick Film, 0402	ERJ-2GEJ471X	Panasonic
54	1	R23	RES, 4.70 k Ω , 1%, 1/10 W, Thick Film, 0402	ERJ-2RKF4701X	Panasonic
55	1	R24	RES, 4.70 k Ω , 1%, 1/10 W, Thick Film, 0402	ERJ-2RKF4701X	Panasonic
56	1	R25	RES, 5.1 Ω , 5%, 1/8 W, Thick Film, 0805	ERJ-6GEYJ5R1V	Panasonic
57	1	R26	RES, 5.1 Ω , 5%, 1/8 W, Thick Film, 0805	ERJ-6GEYJ5R1V	Panasonic
58	1	R27	RES, 10 k Ω , 5%, 1/16 W, Thick Film, 0402	RC0402JR-0710KL	Yageo
59	1	R28	RES, 470 Ω , 5%, 1/10 W, Thick Film, 0402	ERJ-2GEJ471X	Panasonic
60	1	R29	RES, 10 k Ω , 5%, 1/16 W, Thick Film, 0402	RC0402JR-0710KL	Yageo
61	1	RT1	NTC Thermistor, 2.5 Ohms, 3 A	SL08 2R503	Ametherm
62	1	SW1	SWITCH TACTILE SPST-NO 0.05A 12 V	EVQ-PE105K	Panasonic
63	1	SW2	SWITCH TACTILE SPST-NO 0.05A 12 V	EVQ-PE105K	Panasonic
64	1	T2	Bobbin, EQ30, 10 pins, Vertical (low profile) Transformer Transformer	CSV-EQ30-1S-10P POL-INN034 RLPI-1013	Ferroxcube Premier Magnetics Renco
65	1	TP1	Test Point, BLK, THRU-HOLE MOUNT	5011	Keystone
66	1	TP2	Test Point, WHT, THRU-HOLE MOUNT	5012	Keystone
67	1	TP3	Test Point, RED, THRU-HOLE MOUNT	5010	Keystone
68	1	TP4	Test Point, BLK, THRU-HOLE MOUNT	5011	Keystone
69	1	U1	InnoSwitch3-Pro, InSOP24D	INN3377C-H301	Power Integrations
70	1	U3	IC, PIC, PIC®, XLP™, 16F Microcontroller IC, 8-Bit, 32 MHz, 14KB (8K x 14,) FLASH 16-UQFN (4x4)	PIC16F18325-I/JQ	Microchip Tech
71	1	VR1	16 V, 5%, 150 mW, SSMINI-2	DZ2S160M0L EDZVT2R16B	Panasonic ROHM
72	1	VR2	DIODE ZENER 51 V 500 mW SOD123	MMSZ5262BT1G	On Semi

7 Transformer (T2) Specification

7.1 Electrical Diagram

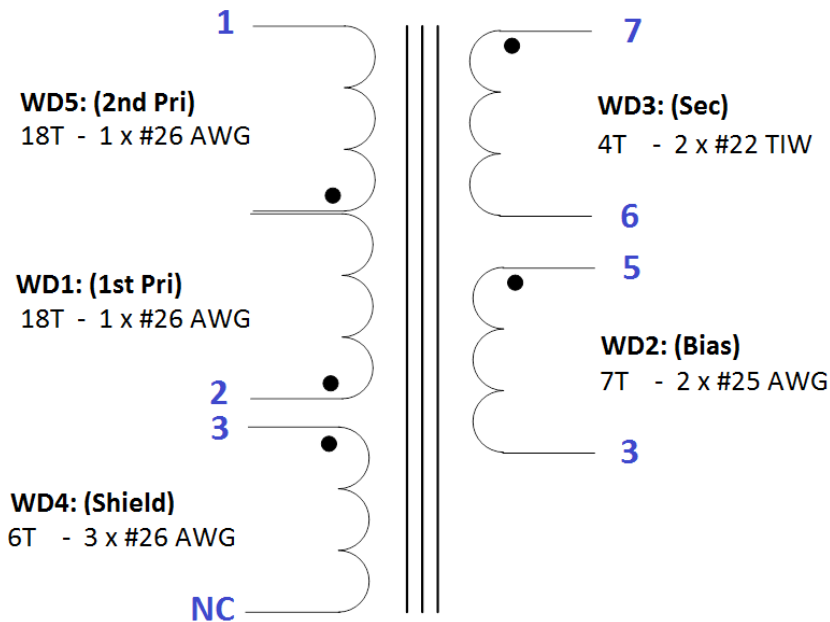

Figure 6 – Transformer Electrical Diagram.

7.2 Electrical Specifications

Electrical Strength	60 second, 60 Hz, from pins 1, 2, 5, 3 to 7, 6.	3000 VAC
Primary Inductance	Pins 1-2, all other windings open, measured at 100 kHz, 0.4 V _{RMS} .	718 μH ±5%
Primary Leakage Inductance	Pins 1-2, with 7-6 shorted, measured at 100 kHz, 0.4 V _{RMS} .	17.95 μH (Max.)

7.3 Material List

Item	Description
[1]	Core: EQ30 - 3C96.
[2]	Bobbin: EQ30, Vertical, 10 Pins.
[3]	Magnet Wire: #26 AWG Solderable Double Coated.
[4]	Magnet Wire: #22 AWG Triple Insulated Wire.
[5]	Magnet Wire: #25 AWG Solderable Double Coated.
[6]	Tape: Polyester Film, 3M, 1 mil thick, 8.2 mm Wide.
[7]	Tape: Polyester Film, 3M, 1 mil thick, 18.2 mm Wide.
[8]	Varnish: Dolph BC-359.
[9]	Tape: Copper Foil, 6 to 6.3 mm Wide.

7.4 Transformer Build Diagram

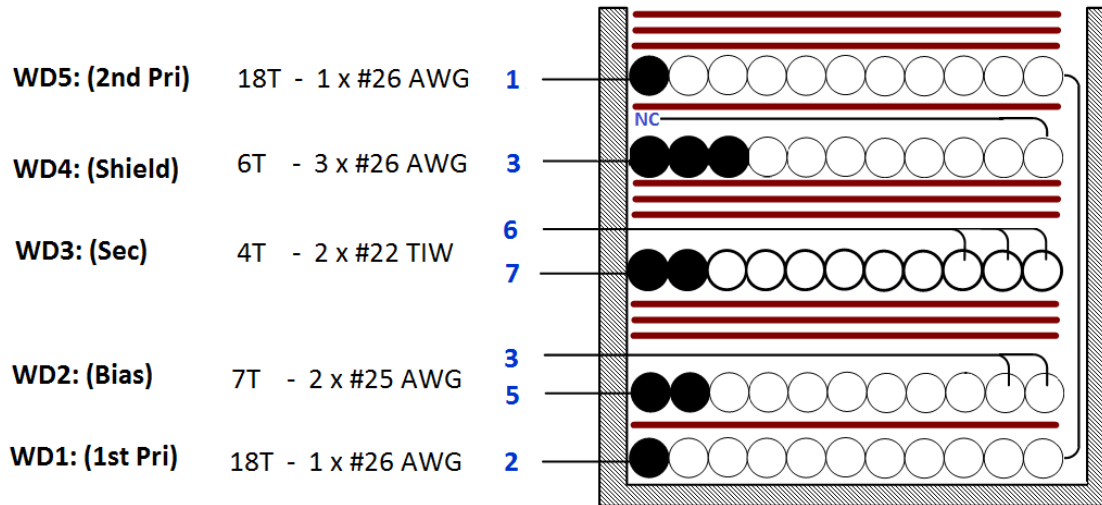
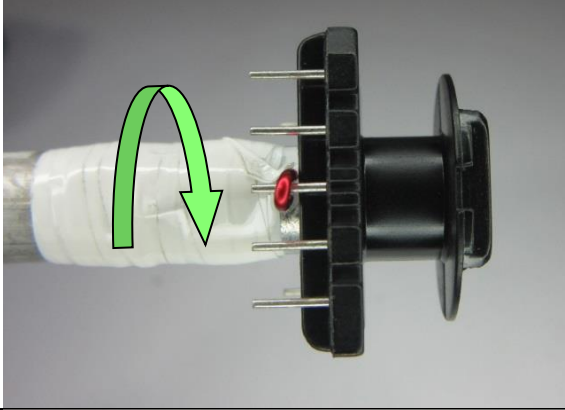
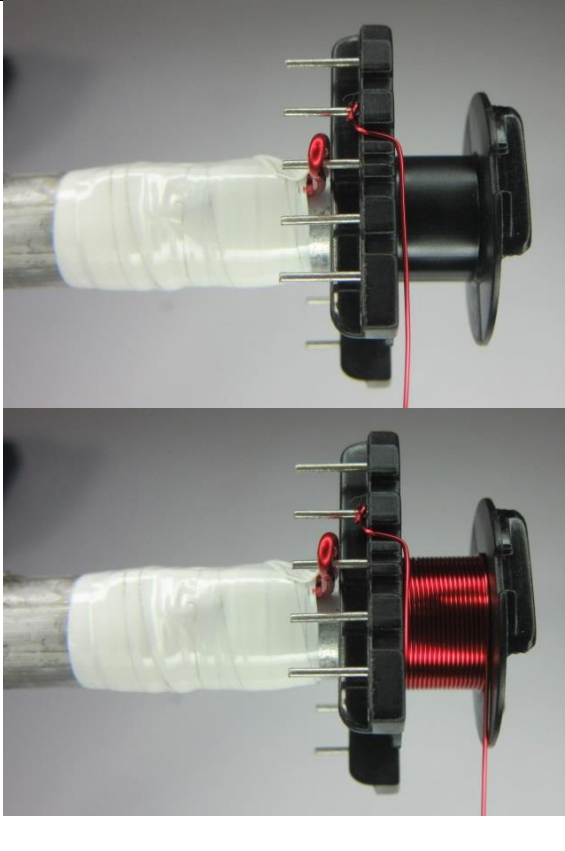

Figure 7 – Transformer Build Diagram.

7.5 Transformer Construction

Winding Preparation	Position the bobbin item [2] on the mandrel such that the pin side of the bobbin is on the left side. Winding direction is clock-wise direction.
WD1 1st Primary	Start at pin 2, wind 18 turns of wire item [3] in 1 layer. At the last turn, leave the wire hanging and enough length for the 2 nd primary.
Insulation	1 layer of tape item [6].
WD2 Bias	Start at pin 5, wind 7 bi-filar turns of wire item [5] in 1 layer, from left to right, spread the wires evenly across the width of the bobbin. At the last turn bring these wires back to the left and finish at pin 3.
Insulation	3 layer of tape item [6].
WD3 Secondary	Start on pin 7 on the secondary side of the bobbin, use 2 wires item [4]. Wind 4 turns in 1 layer, from left to right, at the last turn bring these wires back to the left, finish winding at pin 6.
Insulation	3 layer of tape item [6].
WD4 Shield	Start at pin 3, wind 6 tri-filar turns of wire item [3] in 1 layer. At the last turn, bring these wires back to the left and cut wires for no-connect.
Insulation	1 layer of tape item [6].
WD1 2nd Primary	Use wire hanging from WD1 and continue winding 18 turns from right to left. At the last turn, finish winding at pin 1.
Insulation	Place 3 layers of tape item [6] for insulation and secure the windings.
Finish	Gap core halves to get 718 μ H inductance. Cover the whole core with copper foil as shown. Use small length of item [3] and Solder it to pin 3 and the copper foil. Secure and cover core with 3 layers of tape item [7]. Remove pin 4, 8, 9 and 10. Varnish item [8].

7.6 Winding Illustrations

Winding Preparation		Position the bobbin Item [2] on the mandrel such that the pin side of the bobbin is on the left side. Winding direction is clockwise direction.
WD1 1st Primary		Start at pin 2, wind 8 turns of wire Item [3] in 1 layer. At the last turn, leave the wire hanging and enough length for the 2nd primary.

<p>Insulation</p>		<p>1 layer of tape Item [6].</p>
<p>WD2 Bias</p>		<p>Start at pin 5, wind 7 bi-filar turns of wire Item [5] in 1 layer, from left to right, spread the wires evenly across the width of the bobbin. At the last turn bring these wires back to the left and finish at pin 3.</p>
<p>Insulation</p>		<p>3 layers of tape Item [6].</p>

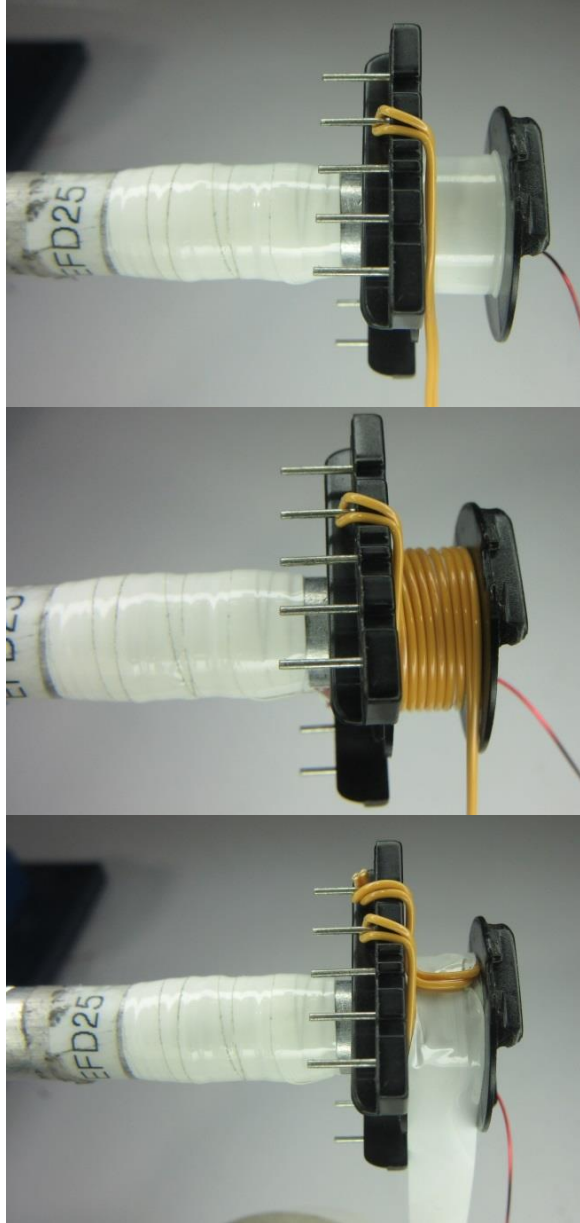
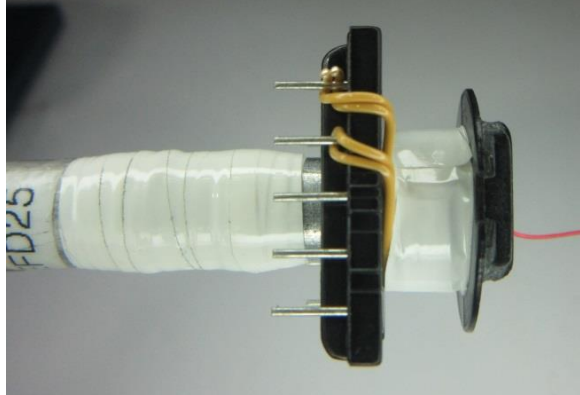
<p>WD3 Secondary</p>		<p>Start on pin 7 on the secondary side of the bobbin, use 2 wires Item [4]. Wind 4 turns in 1 layer, from left to right, at the last turn bring these wires back to the left, finish winding at pin 6.</p>
<p>Insulation</p>		<p>3 layers of tape Item [6].</p>

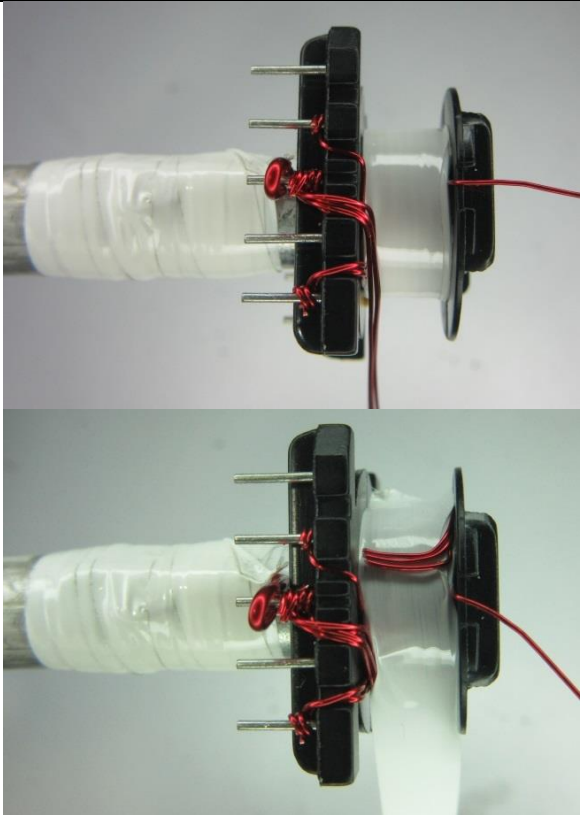
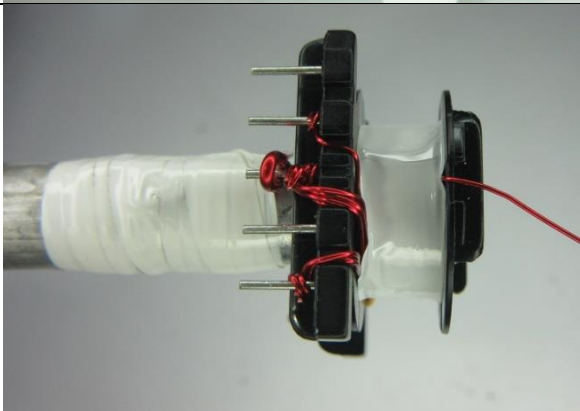
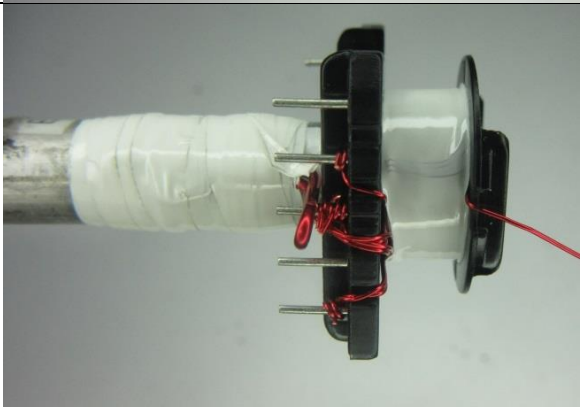
<p>WD4 Shield</p>		<p>Start at pin 3, wind 6 trifilar turns of wire Item [3] in 1 layer. At the last turn, bring these wires back to the left and cut wires for no-connect.</p>
<p>Insulation</p>		<p>1 layers of tape Item [6].</p>
<p>WD5 2nd Primary</p>		<p>Use wire hanging from WD1 and Continue winding 18 turns from right to left. At the last turn, finish winding at pin1</p>

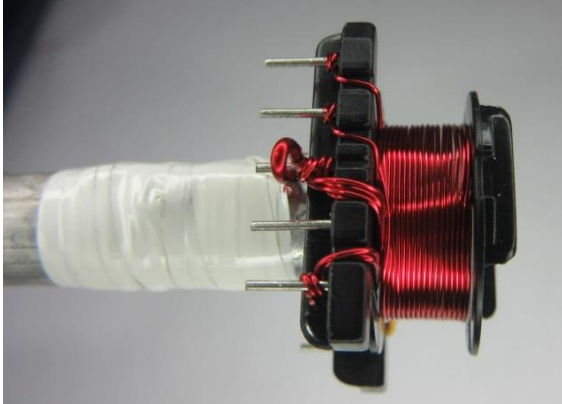
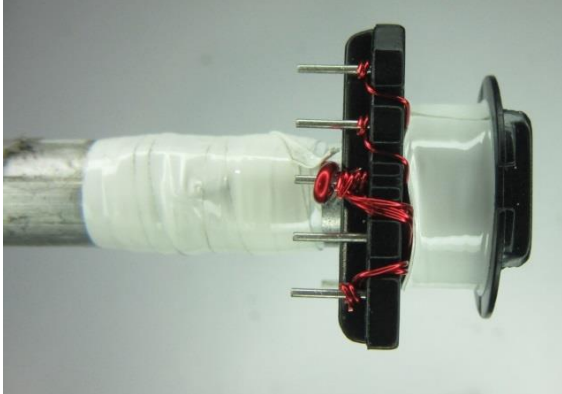
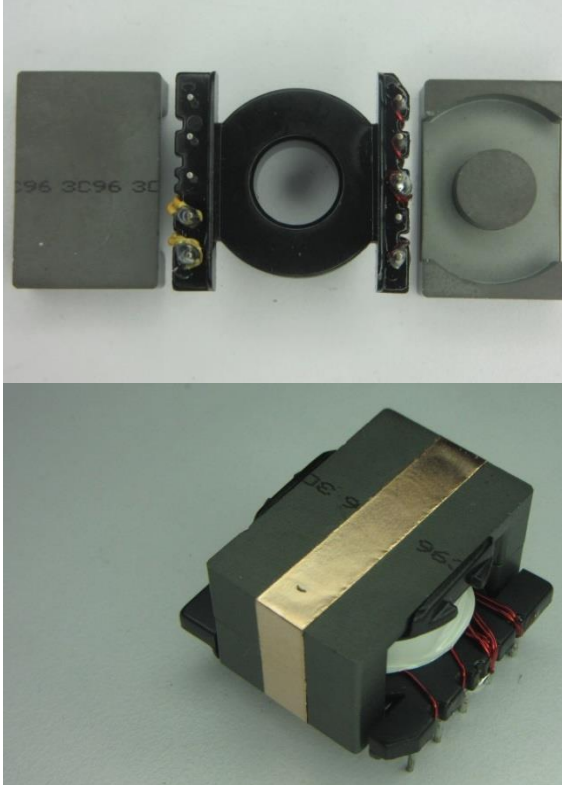
		
<p>Insulation</p>		<p>Place 3 layers of tape Item [6] for insulation and secure the windings.</p>
<p>Finish</p>		<p>Gap core halves to get 718 μH inductance. Cover the whole core with copper foil item [9] as shown. Use small length of item [3] and solder it to pin 3 and the copper foil. Secure and cover core with 3 layers of tape item [7]. Remove pins 4, 8, 9 and 10. Varnish item [8].</p>

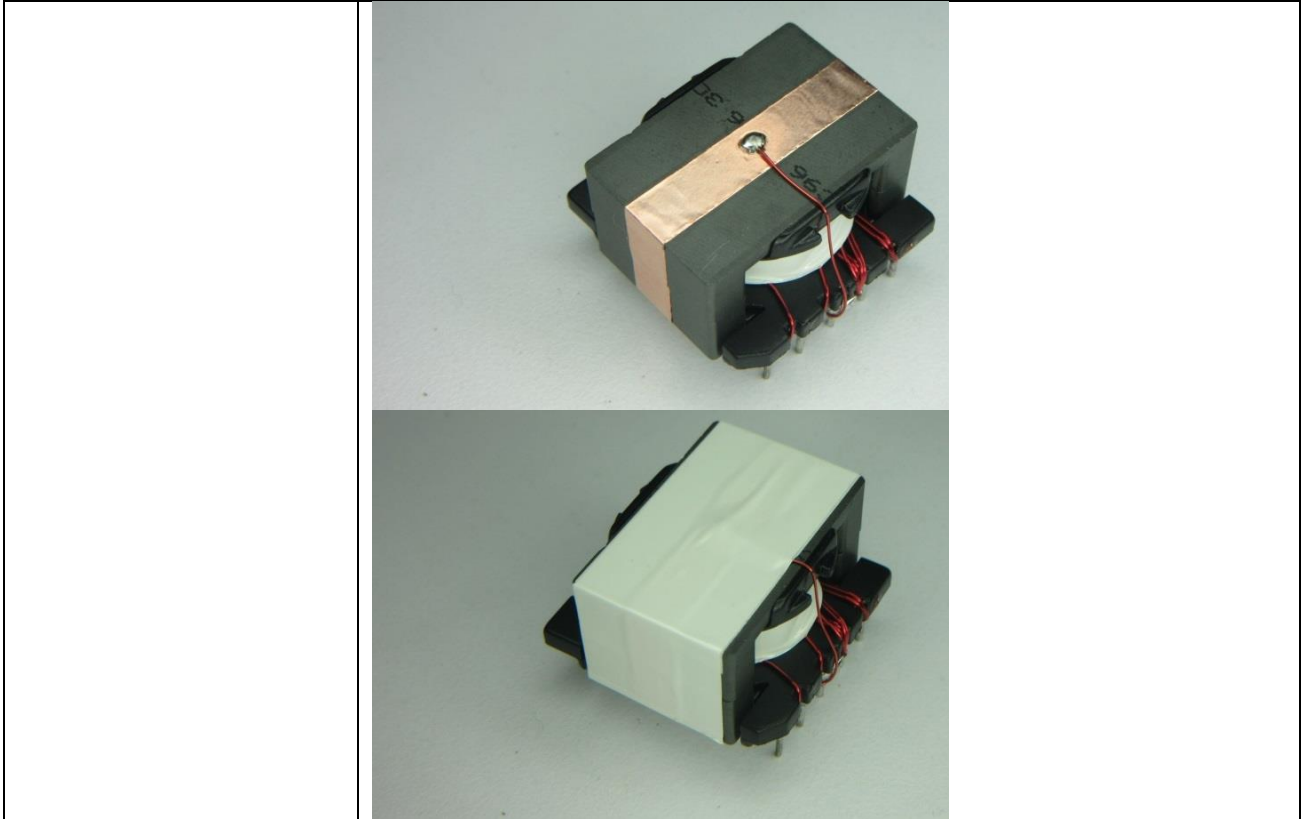

8 Common Mode Choke Specifications

8.1 108 μ H Common Mode Choke (L2)

8.1.1 Electrical Diagram

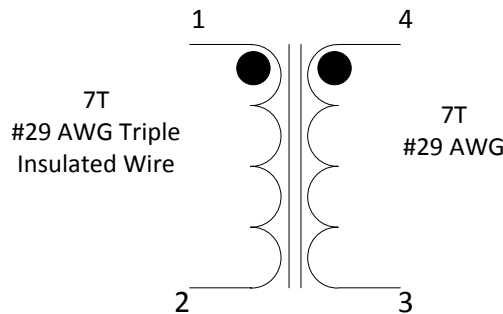

Figure 8 – Inductor Electrical Diagram.

8.1.2 Electrical Specifications

Inductance	Pins 1-2 measured at 100 kHz, 0.4 RMS.	108 μ H \pm 20%
Primary Leakage Inductance	Pins 1-2, with 3-4 shorted.	0.5 μ H

8.1.3 Material List

Item	Description
[1]	Toroid: FERRITE INDUCTR TOROID .415" O.D.;Mfg Part number: 35T0375-10H. Dim: 9.53 mm O.D. x 4.75 mm I.D. x 3.18 mm L.
[2]	Magnet Wire: #29 AWG.
[3]	Triple Insulated Wire #29 AWG.

8.1.4 Illustrations

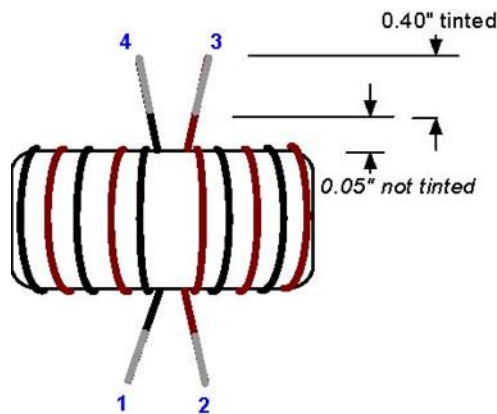

Figure 9 – CMC L2 Top View.



Figure 10 – CMC L2 Front View.

8.2 19.8 mH Common Mode Choke (L1)

8.2.1 Electrical Diagram

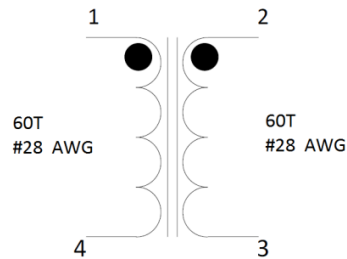

Figure 11 – Inductor Electrical Diagram.

8.2.2 Electrical Specifications

Inductance	Pins 1-4 and pins 2-3 measured at 100 kHz, 0.4 RMS.	~19.8 mH ±25%
Core effective Inductance		5500 nH/N ²
Primary Leakage Inductance	Pins 1-4, with 2-3 shorted.	~80µH

8.2.3 Materials List

Item	Description
[1]	Toroid: FERRITE INDUCTR TOROID T14 x 8 x 5.5. PI Part number: #32-00286-00.
[2]	Divider: Cable-tie, Panduit, PLT.6M-M, 75-00202-00
[3]	Magnet Wire: #28 AWG Heavy Nyleze.
[4]	Epoxy: Devcon, 14270, 5 min Epoxy; or Equivalent.

8.2.4 Winding Instructions

- Place 2 pieces of cable tie item [2] onto toroid item [1] to divide 2 equal sections.
- Use 4 ft of wire item [3], start as pin 1 wind 60 turns in 2 layers in 1 section of toroid, and end at pin 4.
- Do the same for another section of toroid, start at pin 2 then end at pin 3 symmetrically with last winding
- Apply Epoxy item [4] where leads floating. (see figure 1)

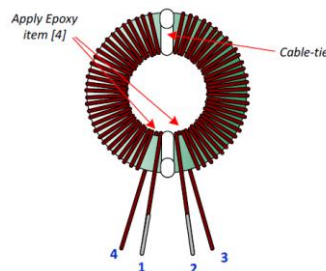

Figure 12 – Inductor Illustration

9 Transformer Design Spreadsheet

1	ACDC_InnoSwitch3-Pro_Flyback_022018; Rev.1.0; Copyright Power Integrations 2018	INPUT	INFO	OUTPUT	UNITS	InnoSwitch3-Pro Flyback Design Spreadsheet
2	APPLICATION VARIABLES					
3	VAC_MIN			85	V	Minimum AC line voltage
4	VAC_MAX			265	V	Maximum AC input voltage
5	VAC_RANGE			UNIVERSAL		AC line voltage range
6	FLINE			60	Hz	AC line voltage frequency
7	CAP_INPUT	101.0		101.0	uF	Input capacitance
9	SETPOINT 1					
10	VOUT1	20.00		20.00	V	Output voltage 1, should be the highest output voltage required
11	IOUT1	2.000		2.000	A	Output current 1
12	POUT1			40.00	W	Output power 1
13	EFFICIENCY1	0.90		0.90		Converter efficiency for output 1
14	Z_FACTOR1	0.50		0.50		Z-factor for output 1
16	SETPOINT 2					
17	VOUT2	8.00		8.00	V	Output voltage 2
18	IOUT2	5.000		5.000	A	Output current 2
19	POUT2			40.00	W	Output power 2
20	EFFICIENCY2	0.88		0.88		Converter efficiency for output 2
21	Z_FACTOR2	0.50		0.50		Z-factor for output 2
23	SETPOINT 3					
24	VOUT3	5.00		5.00	V	Output voltage 3
25	IOUT3	5.000		5.000	A	Output current 3
26	POUT3			25.00	W	Output power 3
27	EFFICIENCY3	0.86		0.86		Converter efficiency for output 3
28	Z_FACTOR3	0.50		0.50		Z-factor for output 3
30	SETPOINT 4					
31	VOUT4	3.00		3.00	V	Output voltage 4
32	IOUT4	5.000		5.000	A	Output current 4
33	POUT4			15.00	W	Output power 4
34	EFFICIENCY4	0.83		0.83		Converter efficiency for output 4
35	Z_FACTOR4	0.50		0.50		Z-factor for output 4
37	SETPOINT 5					
38	VOUT5			0.00	V	Output voltage 5
39	IOUT5			0.000	A	Output current 5
40	POUT5			0.00	W	Output power 5
41	EFFICIENCY5			0.00		Converter efficiency for output 5
42	Z_FACTOR5			0.00		Z-factor for output 5
44	SETPOINT 6					
45	VOUT6			0.00	V	Output voltage 6
46	IOUT6			0.000	A	Output current 6
47	POUT6			0.00	W	Output power 6
48	EFFICIENCY6			0.00		Converter efficiency for output 6
49	Z_FACTOR6			0.00		Z-factor for output 6
51	SETPOINT 7					
52	VOUT7			0.00	V	Output voltage 7
53	IOUT7			0.000	A	Output current 7
54	POUT7			0.00	W	Output power 7
55	EFFICIENCY7			0.00		Converter efficiency for output 7
56	Z_FACTOR7			0.00		Z-factor for output 7
58	SETPOINT 8					
59	VOUT8			0.00	V	Output voltage 8
60	IOUT8			0.000	A	Output current 8
61	POUT8			0.00	W	Output power 8
62	EFFICIENCY8			0.00		Converter efficiency for output 8
63	Z_FACTOR8			0.00		Z-factor for output 8



65	SETPOINT 9					
66	VOUT9			0.00	V	Output voltage 9
67	IOUT9			0.000	A	Output current 9
68	POUT9			0.00	W	Output power 9
69	EFFICIENCY9			0.00		Converter efficiency for output 9
70	Z_FACTOR9			0.00		Z-factor for output 9
72	VOLTAGE_CDC	0.000		0.000	V	Cable drop compensation desired at full current
76	PRIMARY CONTROLLER SELECTION					
77	ENCLOSURE	OPEN FRAME		OPEN FRAME		Power supply enclosure
78	ILIMIT_MODE	INCREASED		INCREASED		Device current limit mode
79	VDRAIN_BREAKDOWN	725		725	V	Device breakdown voltage
80	DEVICE_GENERIC	INN33X7		INN33X7		Device selection
81	DEVICE_CODE			INN3377C		Device code
82	PDEVICE_MAX			40	W	Device maximum power capability
83	RDSON_25DEG			1.38	Ω	Primary MOSFET on-time resistance at 25°C
84	RDSON_100DEG			2.14	Ω	Primary MOSFET on-time resistance at 100°C
85	ILIMIT_MIN			1.410	A	Primary MOSFET minimum current limit
86	ILIMIT_TYP			1.550	A	Primary MOSFET typical current limit
87	ILIMIT_MAX			1.689	A	Primary MOSFET maximum current limit
88	VDRAIN_ON_MOSFET			1.00	V	Primary MOSFET on-time voltage drop
89	VDRAIN_OFF_MOSFET			623.31	V	Peak drain voltage on the primary MOSFET during turn-off
93	WORST CASE ELECTRICAL PARAMETERS					
94	FSWITCHING_MAX	88000		88000	Hz	Maximum switching frequency at full load and the valley of the minimum input AC voltage
95	VOR	180.0		180.0	V	Voltage reflected to the primary winding (corresponding to setpoint 1) when the primary MOSFET turns off
96	VMIN			92.80	V	Valley of the rectified minimum input AC voltage at full load
97	KP			0.473		Measure of continuous/discontinuous mode of operation
98	MODE_OPERATION			CCM		Mode of operation
99	DUTYCYCLE			0.661		Primary MOSFET duty cycle
100	TIME_ON			12.38	us	Primary MOSFET on-time
101	TIME_OFF			4.97	us	Primary MOSFET off-time
102	LPRIMARY_MIN			681.9	μ H	Minimum primary magnetizing inductance
103	LPRIMARY_TYP			717.8	μ H	Typical primary magnetizing inductance
104	LPRIMARY_TOL			5.0		Primary magnetizing inductance tolerance
105	LPRIMARY_MAX			753.7	μ H	Maximum primary magnetizing inductance
107	PRIMARY CURRENT					
108	I AVG_PRIMARY			0.465	A	Primary MOSFET average current
109	IPEAK_PRIMARY			1.570	A	Primary MOSFET peak current
110	IPEDESTAL_PRIMARY			0.728	A	Primary MOSFET current pedestal
111	IRIPPLE_PRIMARY			1.541	A	Primary MOSFET ripple current
112	IRMS_PRIMARY			0.728	A	Primary MOSFET RMS current
114	SECONDARY CURRENT					
115	IPEAK_SECONDARY			14.134	A	Secondary MOSFET peak current
116	IPEDESTAL_SECONDARY			6.548	A	Secondary MOSFET pedestal current
117	IRMS_SECONDARY			7.371	A	Secondary MOSFET RMS current
118	IRIPPLE_CAP_OUT			5.415	A	Output capacitor ripple current
122	TRANSFORMER CONSTRUCTION PARAMETERS					
123	CORE SELECTION					

124	CORE	Custom		Custom		Core selection
125	CORE NAME	EQ30		EQ30		Core code
126	AE	108.0		108.0	mm ²	Core cross sectional area
127	LE	46.0		46.0	mm	Core magnetic path length
128	AL	3900		3900	nH	Ungapped core effective inductance per turns squared
129	VE	4970		4970	mm ³	Core volume
130	BOBBIN NAME	EQ30		EQ30		Bobbin name
131	AW	52.0		52.0	mm ²	Bobbin window area
132	BW	8.20		8.20	mm	Bobbin width
133	MARGIN			0.0	mm	Bobbin safety margin
135	PRIMARY WINDING					
136	NPRIMARY			36		Primary winding number of turns
137	BPEAK			3351	Gauss	Peak flux density
138	BMAX			3009	Gauss	Maximum flux density
139	BAC			1472	Gauss	AC flux density (0.5 x Peak to Peak)
140	ALG			554	nH	Typical gapped core effective inductance per turns squared
141	LG			0.210	mm	Core gap length
142	LAYERS_PRIMARY			2		Primary winding number of layers
143	AWG_PRIMARY			27		Primary wire gauge
144	OD_PRIMARY_INSULATED			0.418	mm	Primary wire insulated outer diameter
145	OD_PRIMARY_BARE			0.361	mm	Primary wire bare outer diameter
146	CMA_PRIMARY			276.8	Cmils/A	Primary winding wire CMA
148	SECONDARY WINDING					
149	NSECONDARY			4		Secondary winding number of turns
150	AWG_SECONDARY			18		Secondary wire gauge
151	OD_SECONDARY_INSULATED			1.328	mm	Secondary wire insulated outer diameter
152	OD_SECONDARY_BARE			1.024		Secondary wire bare outer diameter
153	CMA_SECONDARY			220.4	Cmils/A	Secondary winding wire CMA
155	BIAS WINDING					
156	NBIAS			7		Bias winding number of turns
160	PRIMARY COMPONENTS SELECTION					
161	LINE UNDERVOLTAGE					
162	BROWN-IN REQUIRED	73.00		73.00	V	Required line brown-in threshold
163	RLS			3.64	MΩ	Connect two 1.82 MOhm resistors to the V-pin for the required UV/OV threshold
164	BROWN-IN ACTUAL			73.04	V	Actual brown-in threshold using standard resistors
165	BROWN-OUT ACTUAL			66.07	V	Actual brown-out threshold using standard resistors
167	LINE OVERVOLTAGE					
168	OVERVOLTAGE_LINE		Warning	304.23	V	The device voltage stress will be higher than 90% of the breakdown voltage when overvoltage is triggered
170	BIAS WINDING					
171	VBIAS	4.00	Info	4.00	V	The rectified bias voltage maybe too low to supply the BP pin: Increase the rectified bias voltage to a value higher than 9V
172	VF_BIAS			0.70	V	Bias winding diode forward drop
173	VREVERSE_BIASDIODE			76.59	V	Bias diode reverse voltage (not accounting parasitic voltage ring)
174	CBIAS			22	uF	Bias winding rectification capacitor
175	CBPP			4.70	uF	BPP pin capacitor
179	SECONDARY COMPONENTS SELECTION					
180	RECTIFIER					
181	VDRAIN_OFF_SRFET			61.48	V	Secondary rectifier reverse voltage (not accounting parasitic voltage ring)
182	SRFET	Auto		AON6280		Secondary rectifier (Logic MOSFET)
183	VBREAKDOWN_SRFET			80	V	Secondary rectifier breakdown voltage



184	RDSON_SRFET			5.0	mΩ	SRFET on time drain resistance at 25degC for VGS=4.4V
188	VARIABLE OUTPUTS ANALYSIS					
189	TOLERANCE CORNER					
190	CORNER_VAC			85	V	Input AC RMS voltage corner to be evaluated
191	CORNER_ILIMIT	TYP		1.550	A	Current limit corner to be evaluated
192	CORNER_LPRIMARY	TYP		717.8	uH	Primary inductance corner to be evaluated
194	SETPOINT SELECTION					
195	SETPOINT	1		1		Select the setpoint which needs to be evaluated
196	FSWITCHING			56882.7	Hz	Maximum switching frequency at full load and the valley of the minimum input AC voltage
197	VOR			180.0	V	Voltage reflected to the primary winding when the primary MOSFET turns off
198	VMIN			93.40	V	Valley of the minimum input AC voltage
199	KP			1.118		Measure of continuous/discontinuous mode of operation
200	MODE_OPERATION			DCM		Mode of operation
201	DUTYCYCLE			0.635		Primary MOSFET duty cycle
202	TIME_ON			11.17	us	Primary controller's maximum on-time
203	TIME_OFF			6.41	us	Primary controller's minimum off-time
205	PRIMARY CURRENT					
206	Iavg_PRIMARY			0.457	A	Primary MOSFET average current
207	IPEAK_PRIMARY			1.438	A	Primary MOSFET peak current
208	IPEDESTAL_PRIMARY			0.000	A	Primary MOSFET current pedestal
209	IRIPPLE_PRIMARY			1.438	A	Primary MOSFET ripple current
210	IRMS_PRIMARY			0.662	A	Primary MOSFET RMS current
212	SECONDARY CURRENT					
213	IPEAK_SECONDARY			12.943	A	Secondary MOSFET peak current
214	IPEDESTAL_SECONDARY			0.000	A	Secondary MOSFET pedestal current
215	IRMS_SECONDARY			4.268	A	Secondary MOSFET RMS current
216	IRIPPLE_CAP_OUT			3.770	A	Output capacitor ripple current
218	MAGNETIC FLUX DENSITY					
219	BPEAK			2929	Gauss	Peak flux density
220	BMAX			2655	Gauss	Maximum flux density
221	BAC			1328	Gauss	AC flux density (0.5 x Peak to Peak)

Note: Although the spreadsheet shows a warning indicating that device voltage stress likely exceeding 90% of the device rating, this voltage will still be safely below the specified voltage breakdown rating of the device and is acceptable since line OV is an abnormal operating condition and hence not expected to be a continuous operating condition.

10 Performance Data

Note: Output voltages measured at PCB end.

10.1 Efficiency vs. Load

10.1.1 Output: 3 V / 5 A

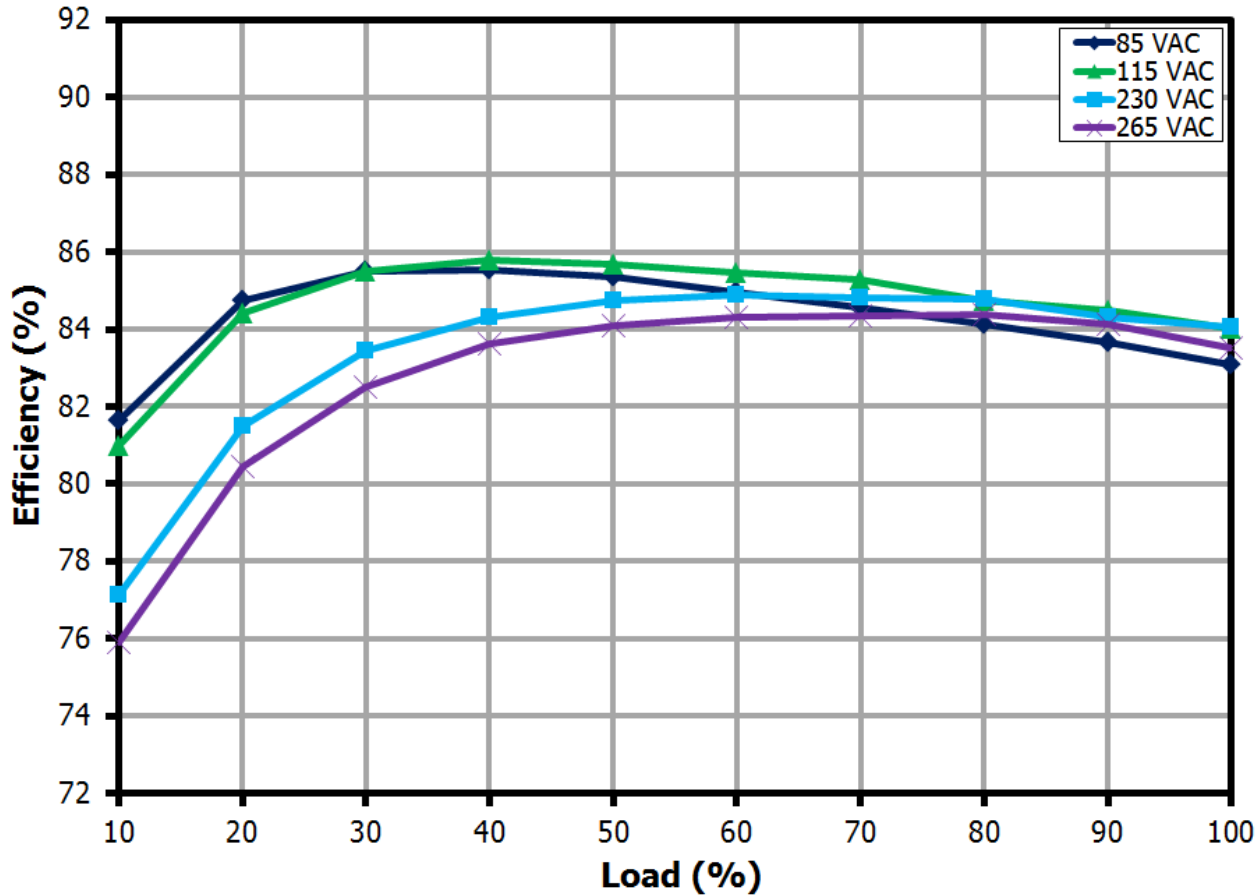

Figure 13 – Efficiency vs. Load, Room Ambient.

10.1.2 Output: 5 V / 5 A

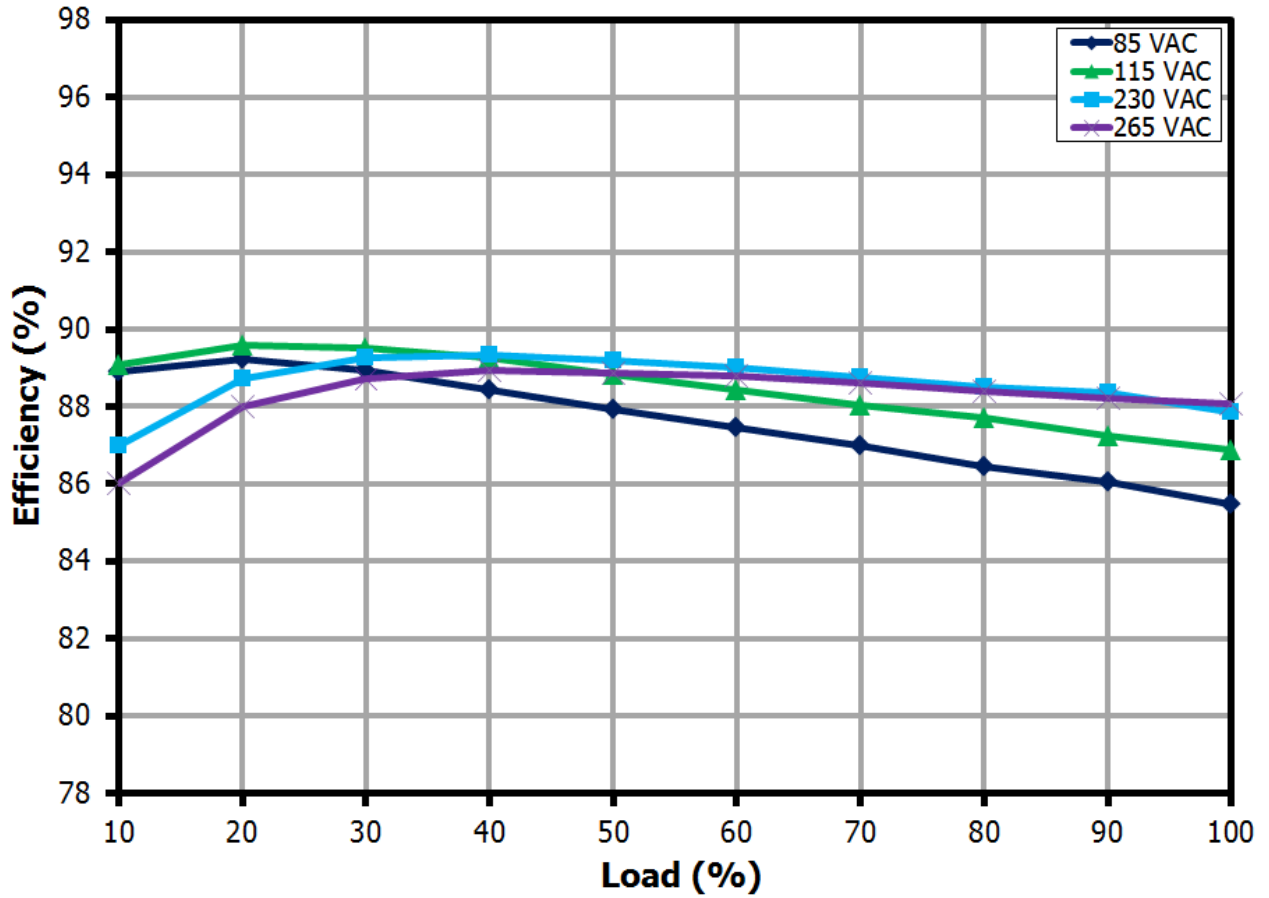

Figure 14 – Efficiency vs. Load, Room Ambient.



10.1.3 Output: 8 V / 5 A

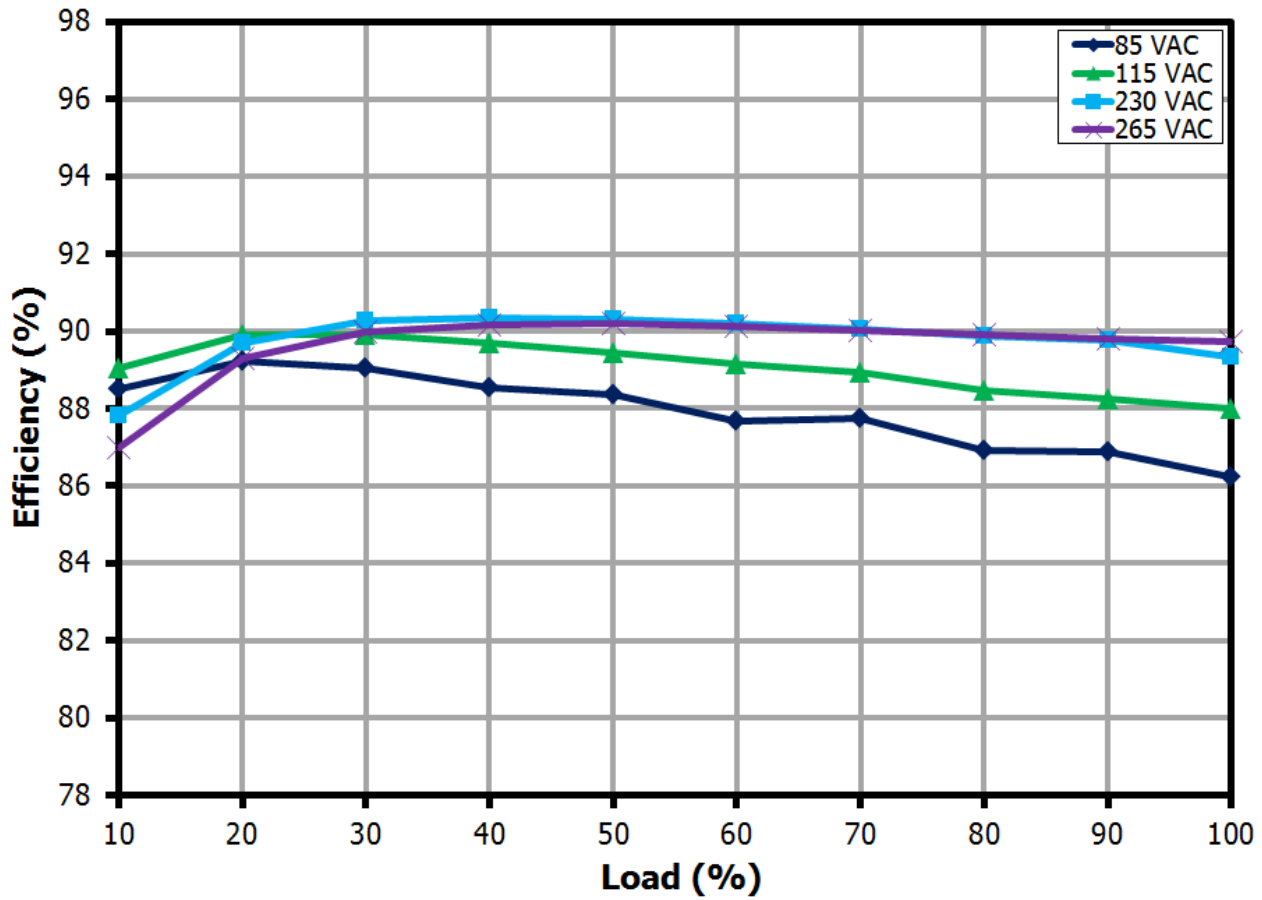

Figure 15 – Efficiency vs. Load, Room Ambient.

10.1.4 Output: 15 V / 2.666 A

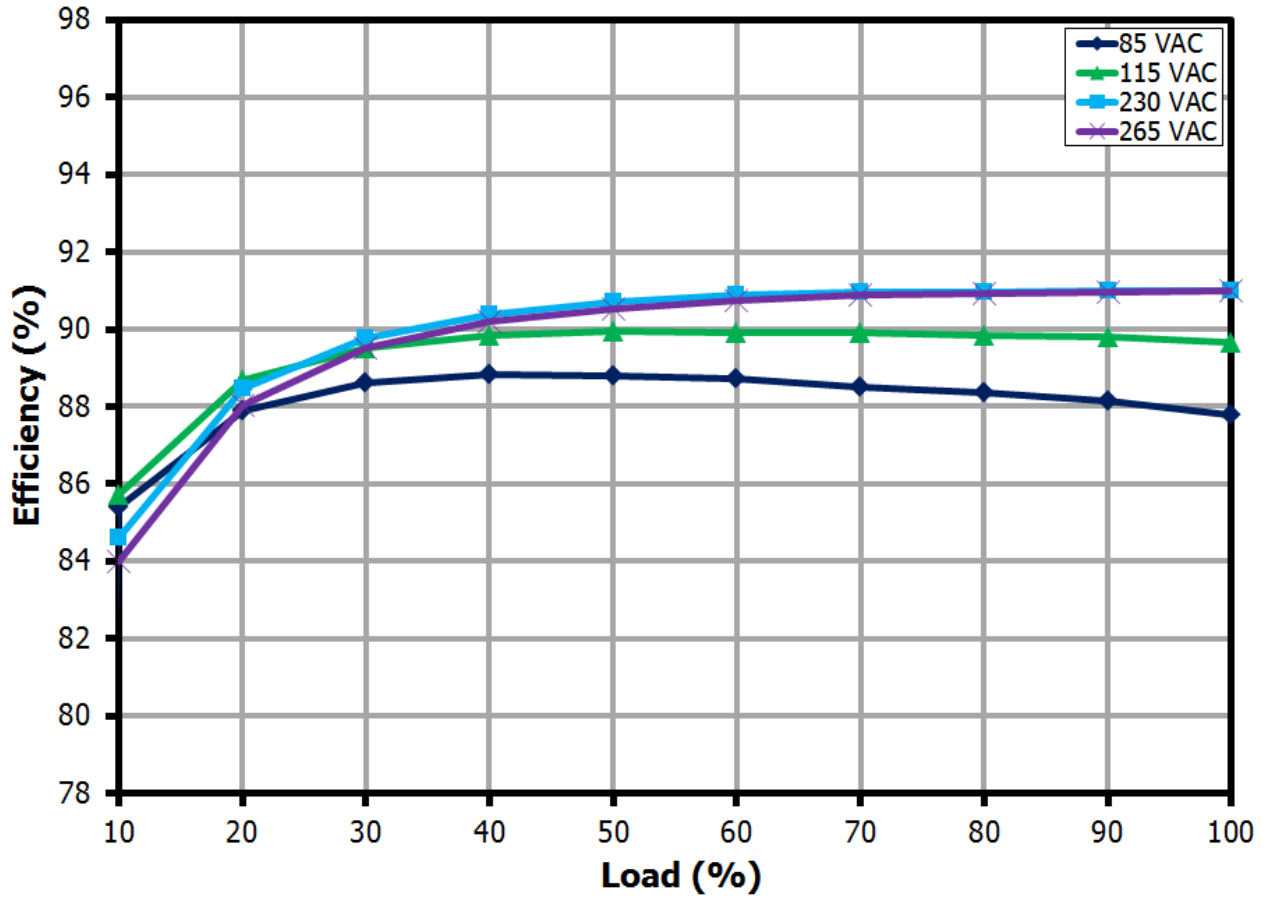

Figure 16 – Efficiency vs. Load, Room Ambient.



10.1.5 Output: 20 V / 2 A

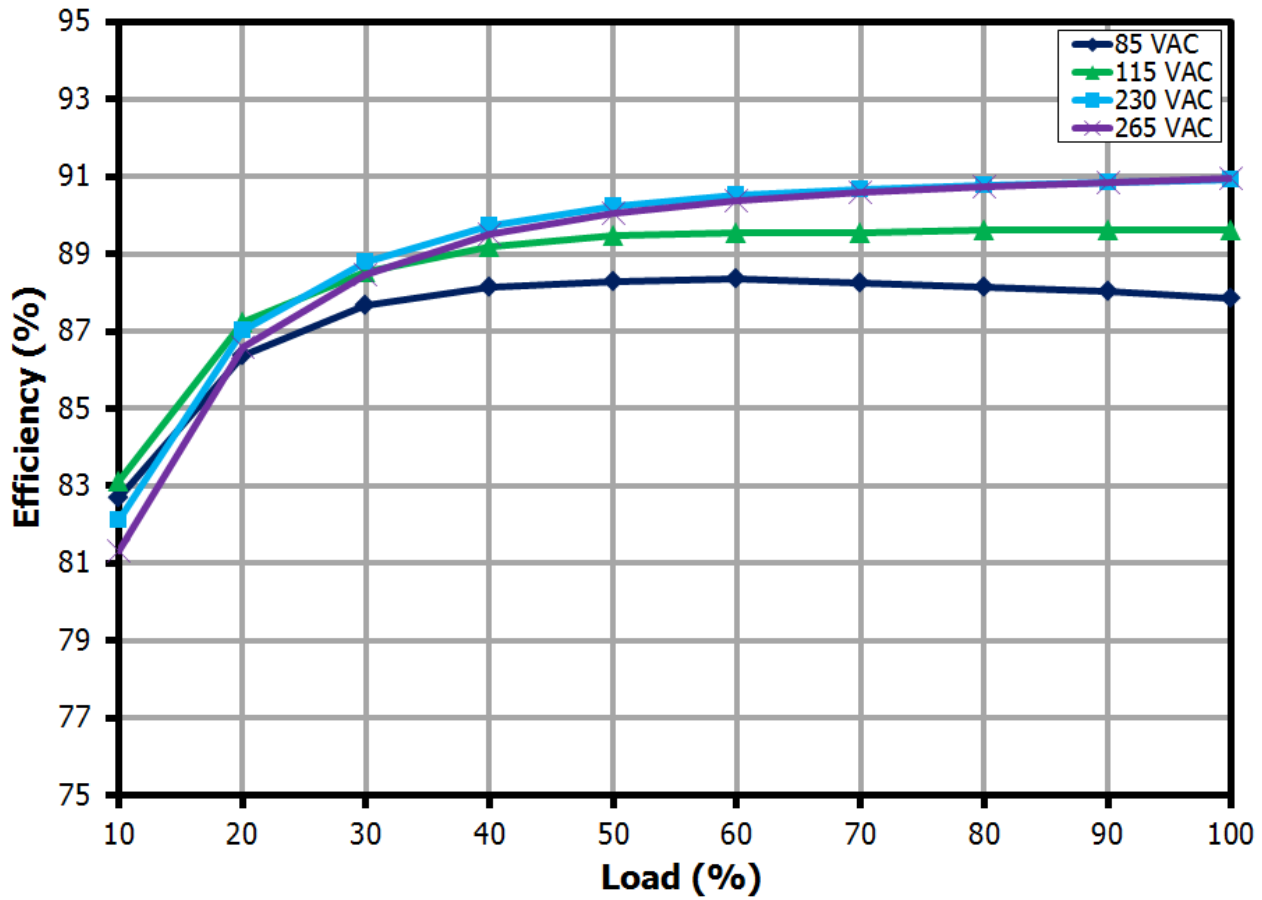

Figure 17 – Efficiency vs. Load, Room Ambient.

10.2 Efficiency vs. Line

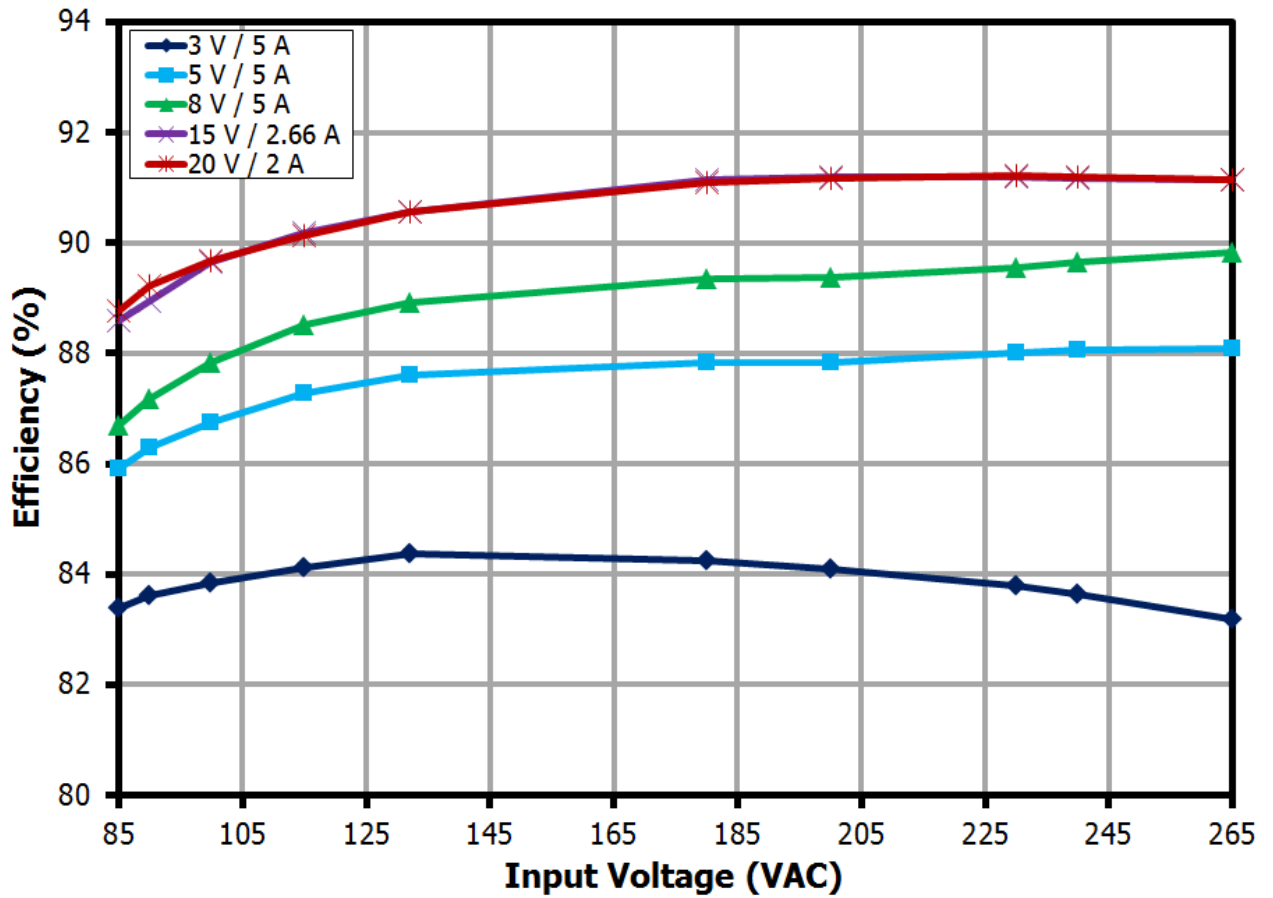

Figure 18 – Efficiency vs. Line, Room Ambient.



10.3 Line Regulation

10.3.1 Output: 3 V / 5 A

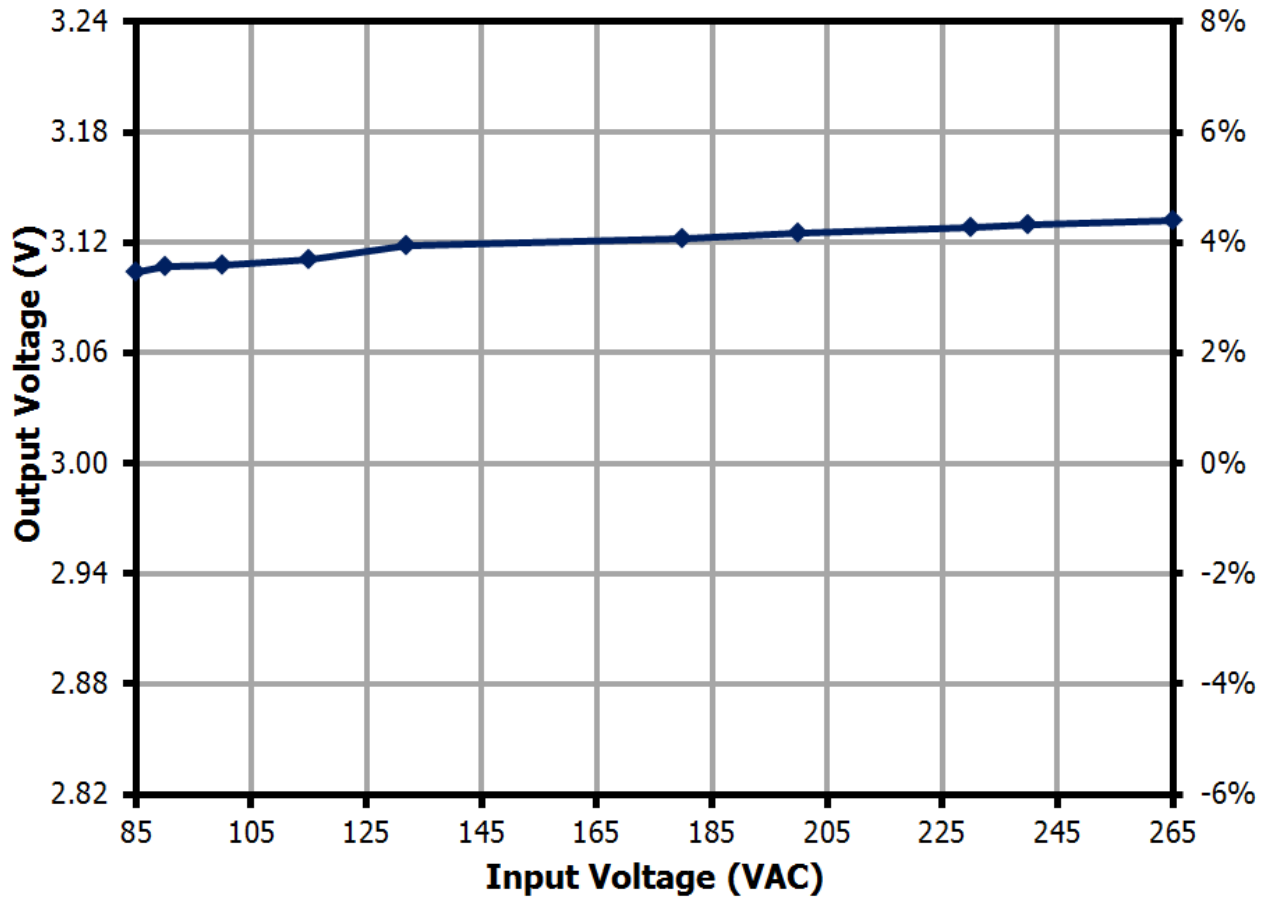

Figure 19 – 3 V Output Regulation vs. Input Line Voltage.



10.3.2 Output: 5 V / 5 A

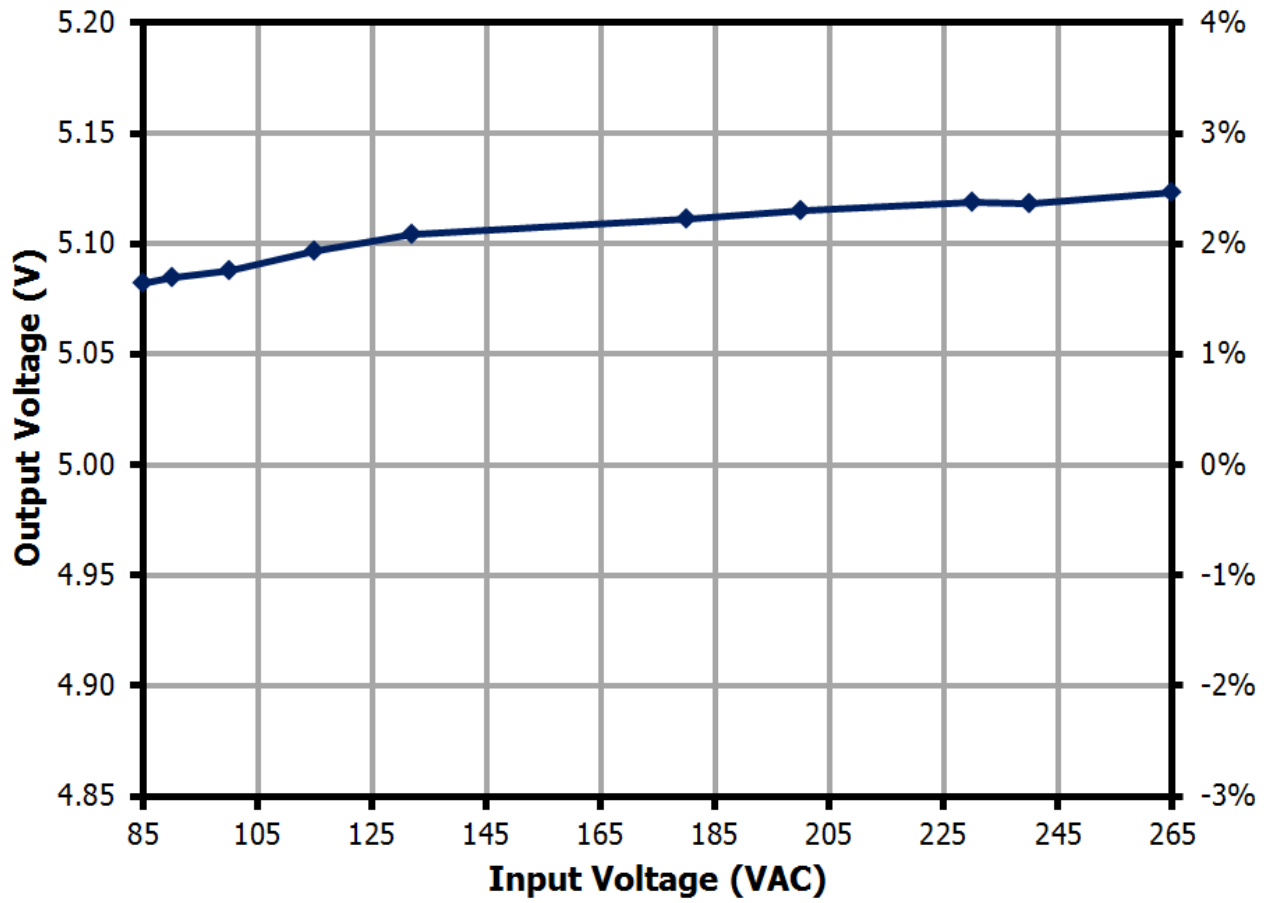

Figure 20 – 5 V Output Regulation vs. Input Line Voltage.



10.3.3 Output: 8 V / 5 A

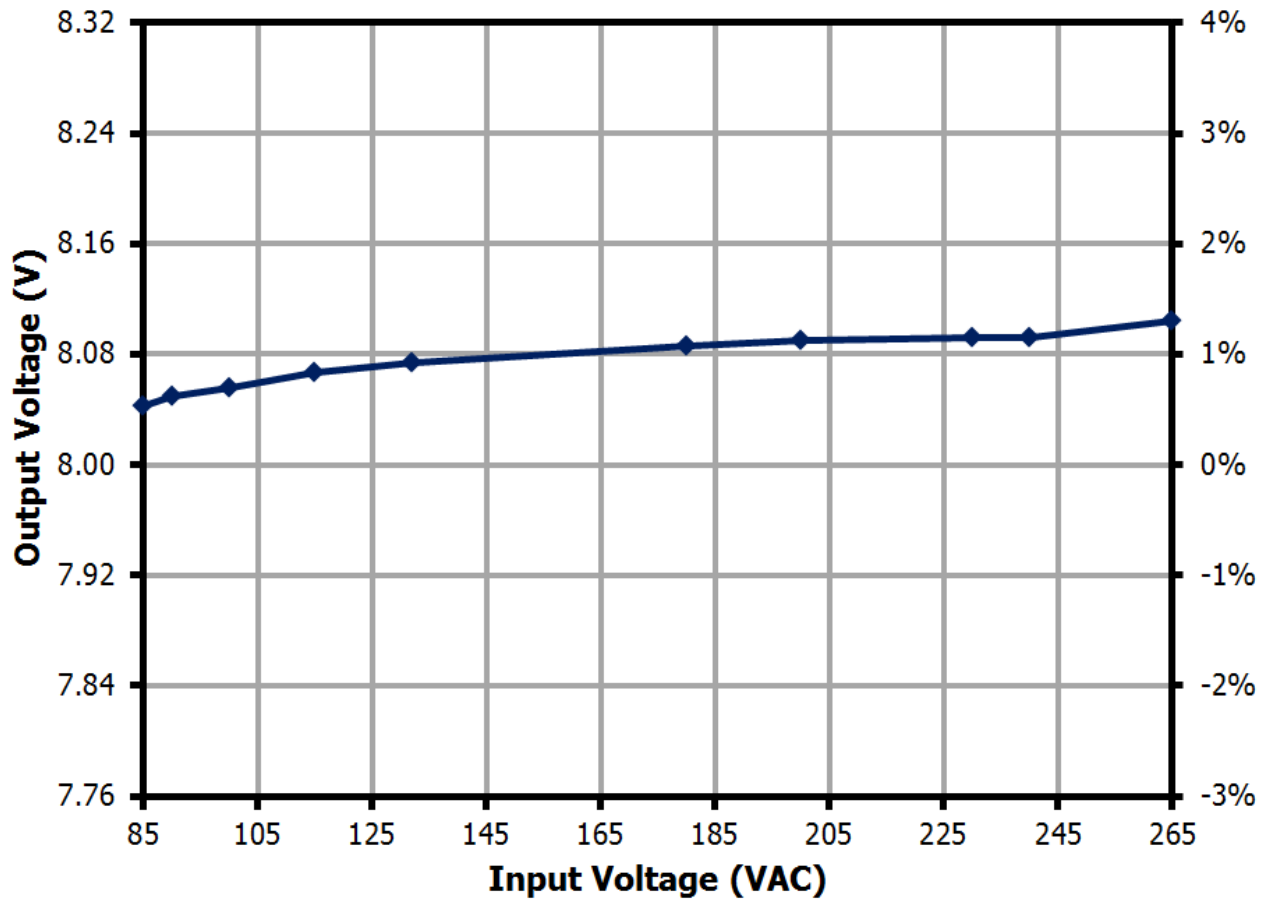

Figure 21 – 8 V Output Regulation vs. Input Line Voltage.

10.3.4 Output: 15 V / 2.666 A

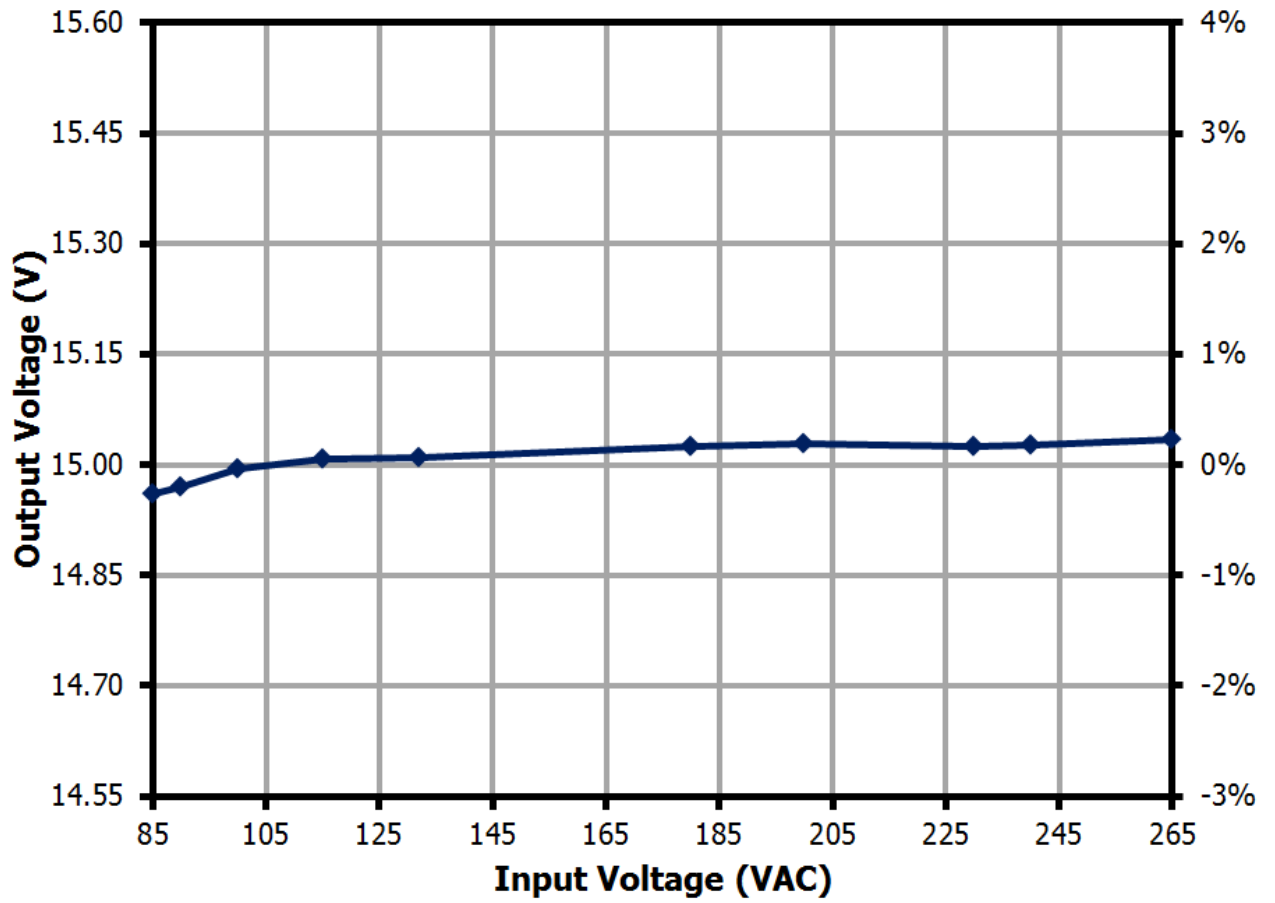

Figure 22 – 15 V Output Regulation vs. Input Line Voltage.



10.3.5 Output: 20 V / 2 A

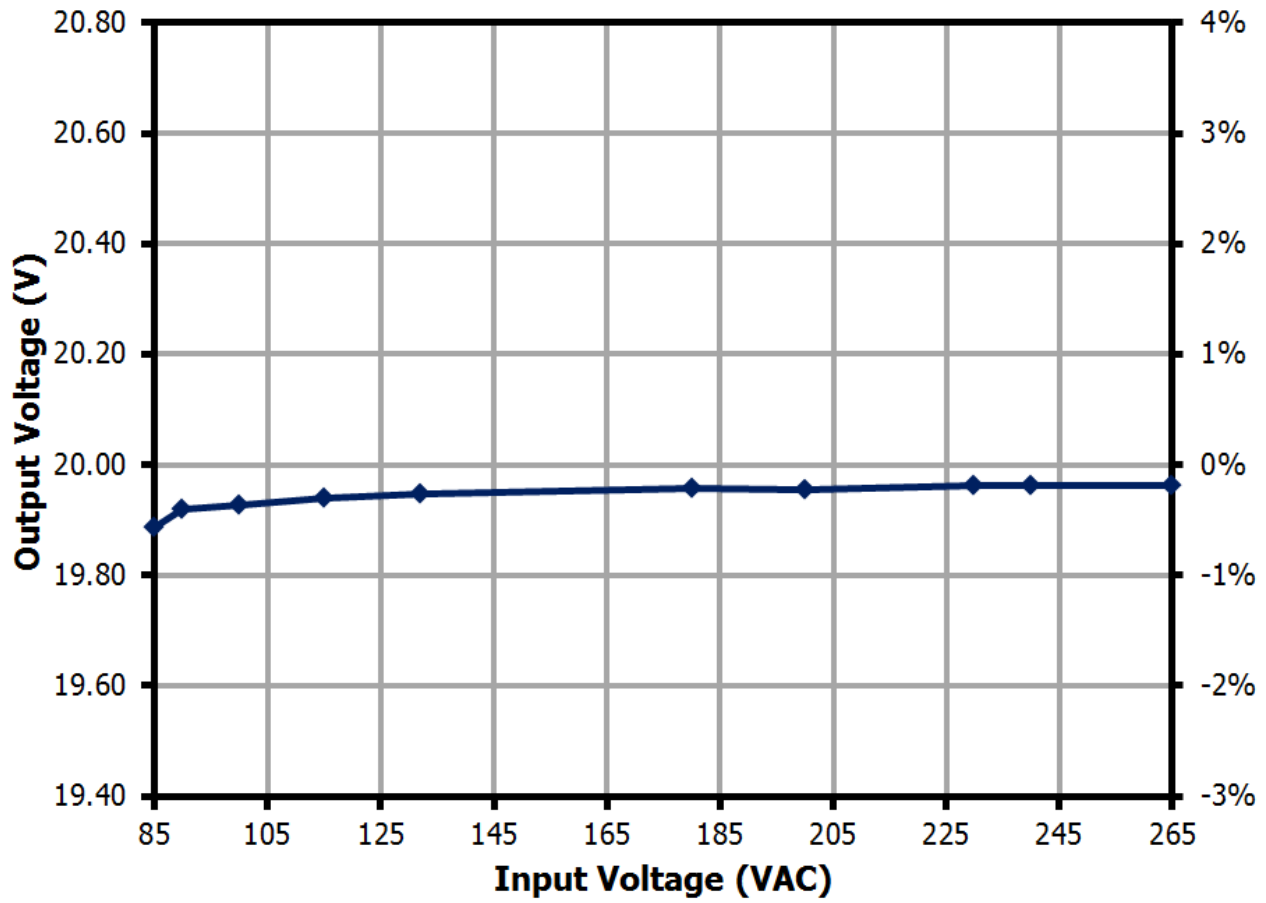

Figure 23 – 20 V Output Regulation vs. Input Line Voltage.

10.4 Load Regulation

10.4.1 Output: 3 V

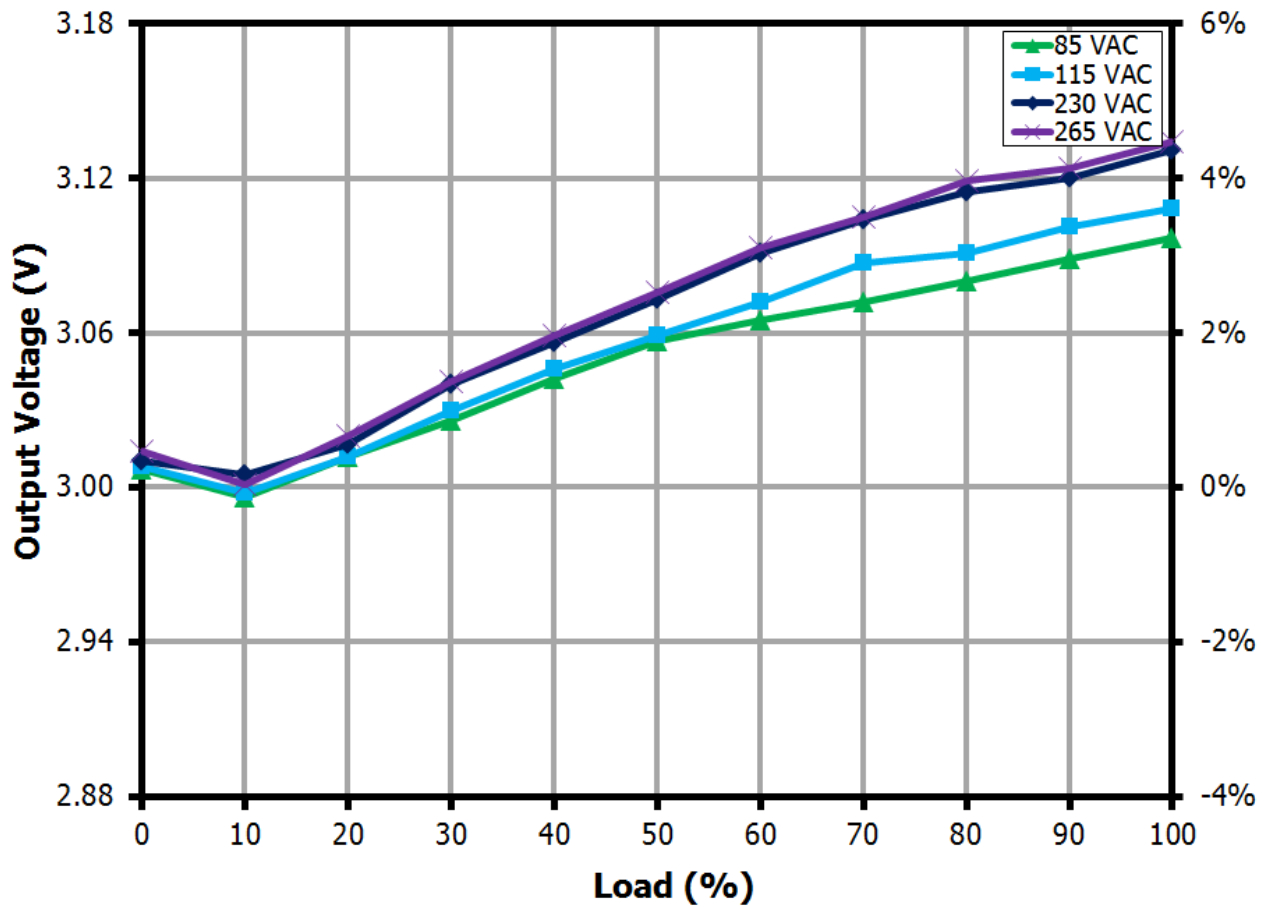

Figure 24 – 3 V Output Regulation vs. Percent Load.



10.4.2 Output: 5 V

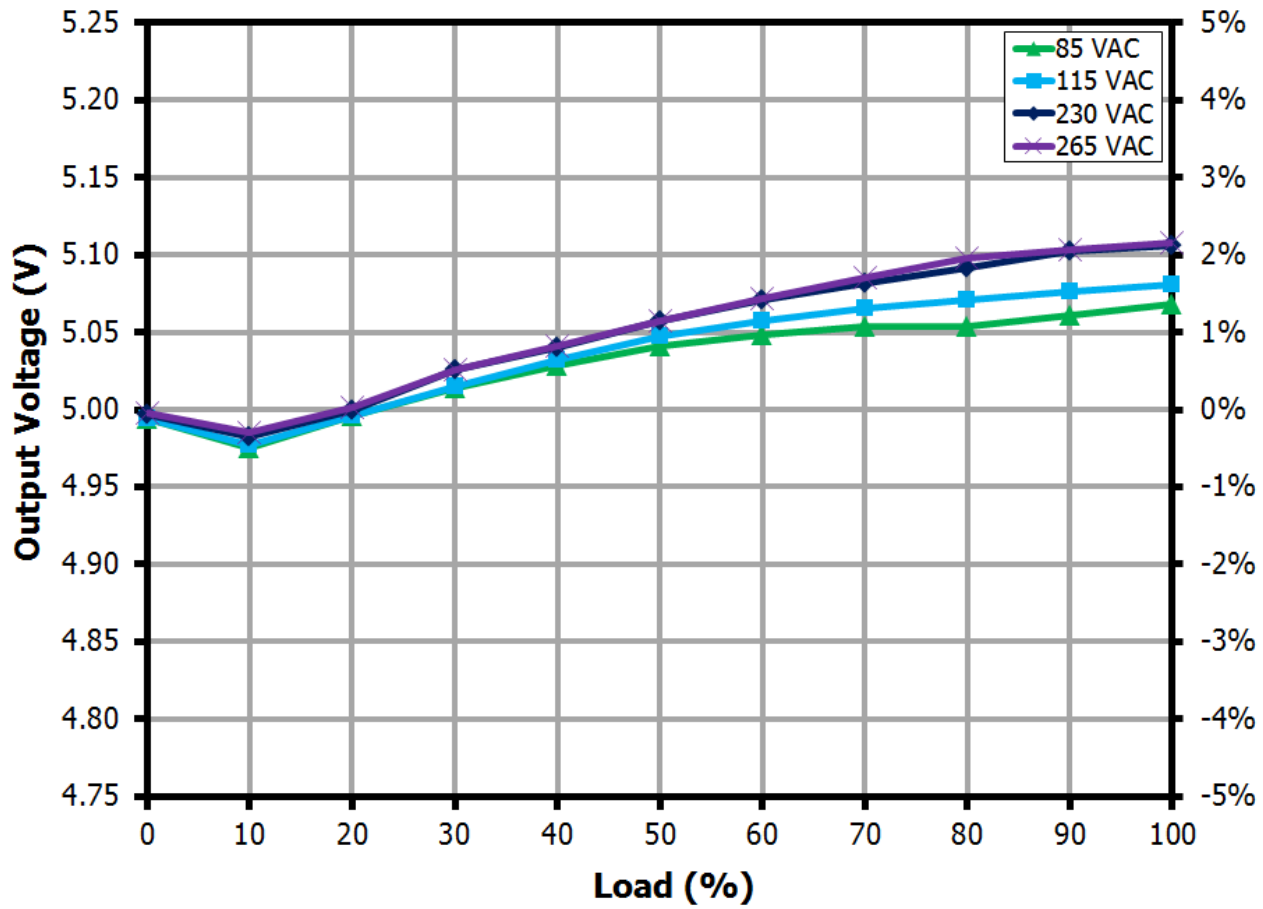

Figure 25 – 5 V Output Regulation vs. Percent Load.



10.4.3 Output: 8 V

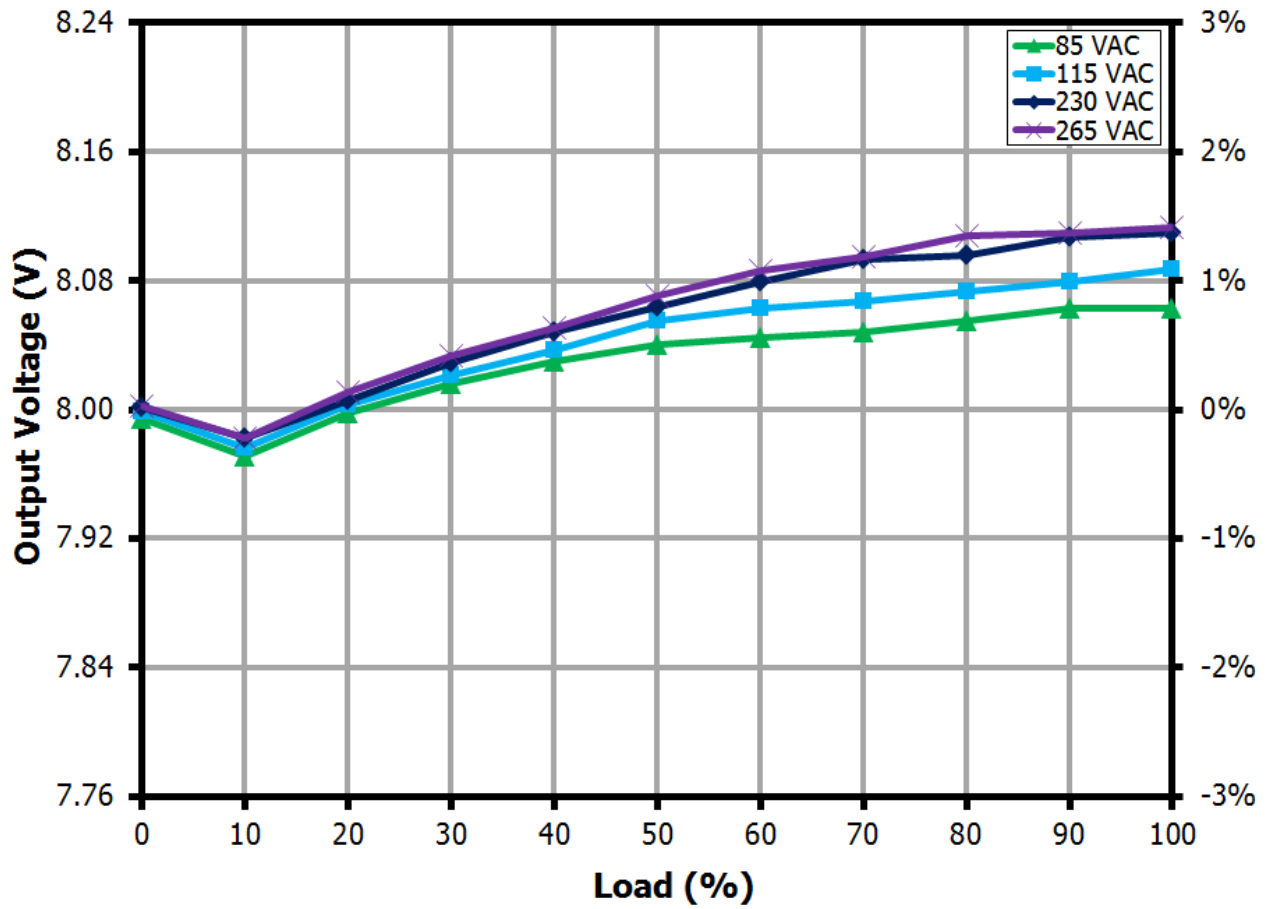

Figure 26 – 8 V Output Regulation vs. Percent Load.



10.4.4 Output: 15 V

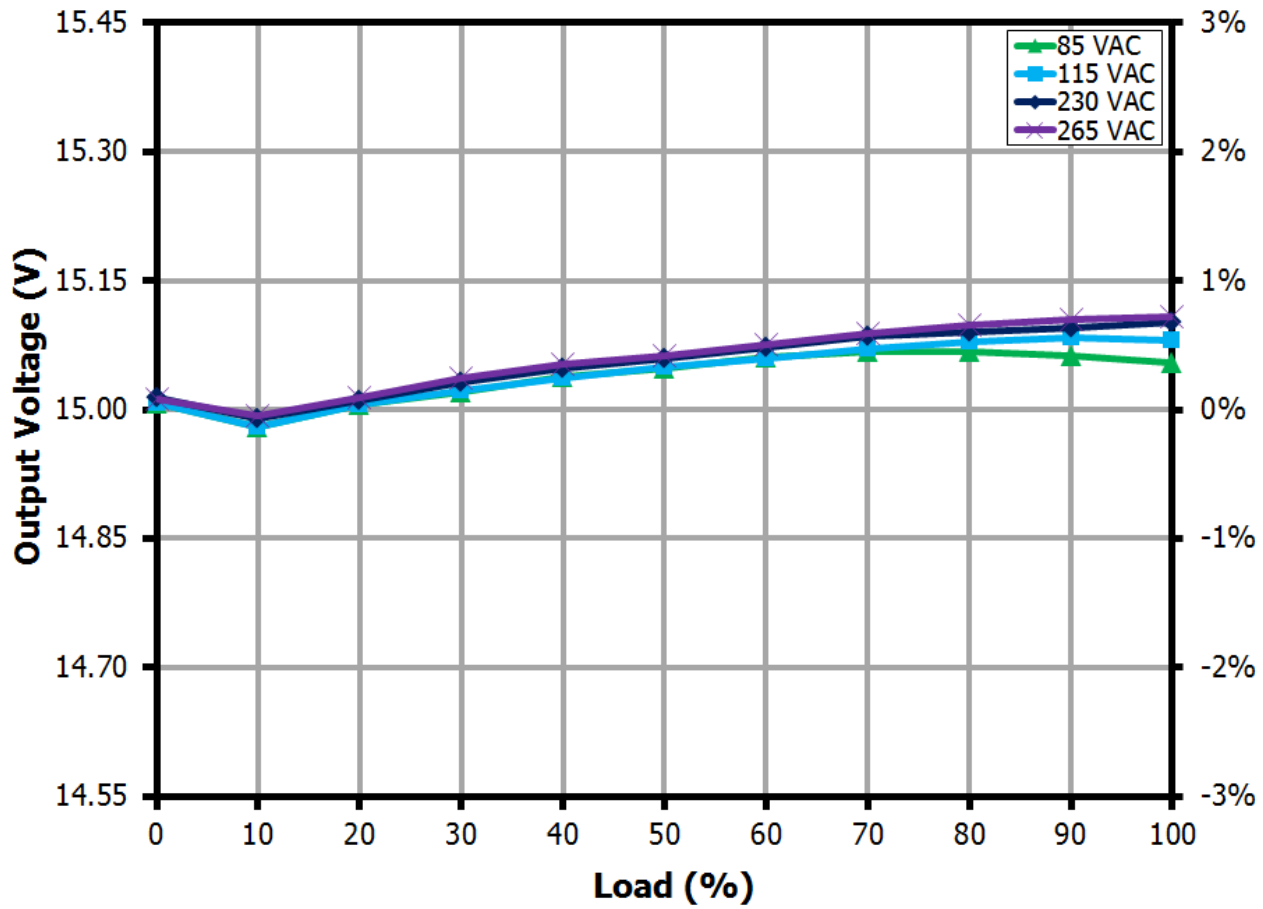

Figure 27 – 15 V Output Regulation vs. Percent Load.

10.4.5 Output: 20 V

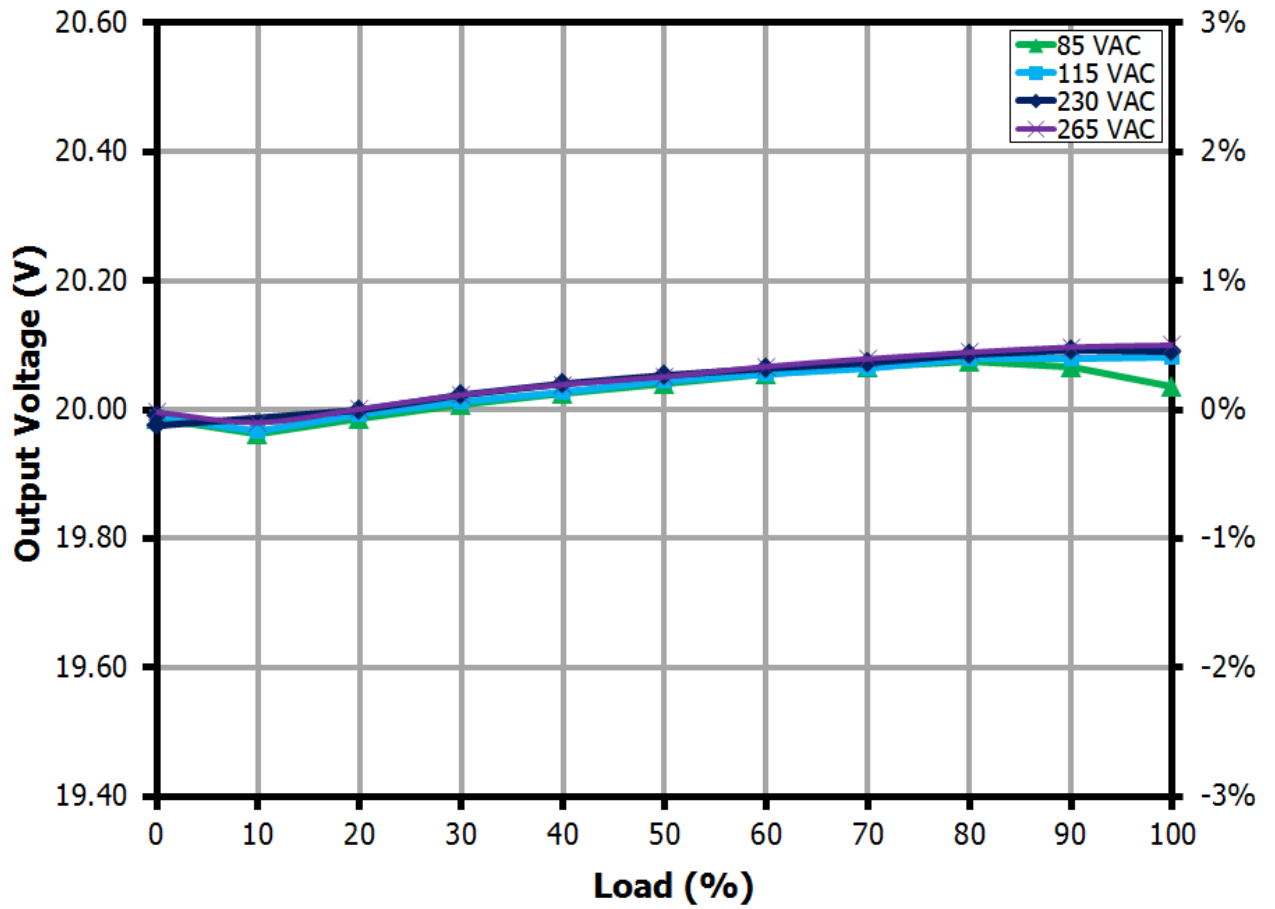

Figure 28 – 20 V Output Regulation vs. Percent Load.



10.5 No-Load Input Power at 5 VOUT

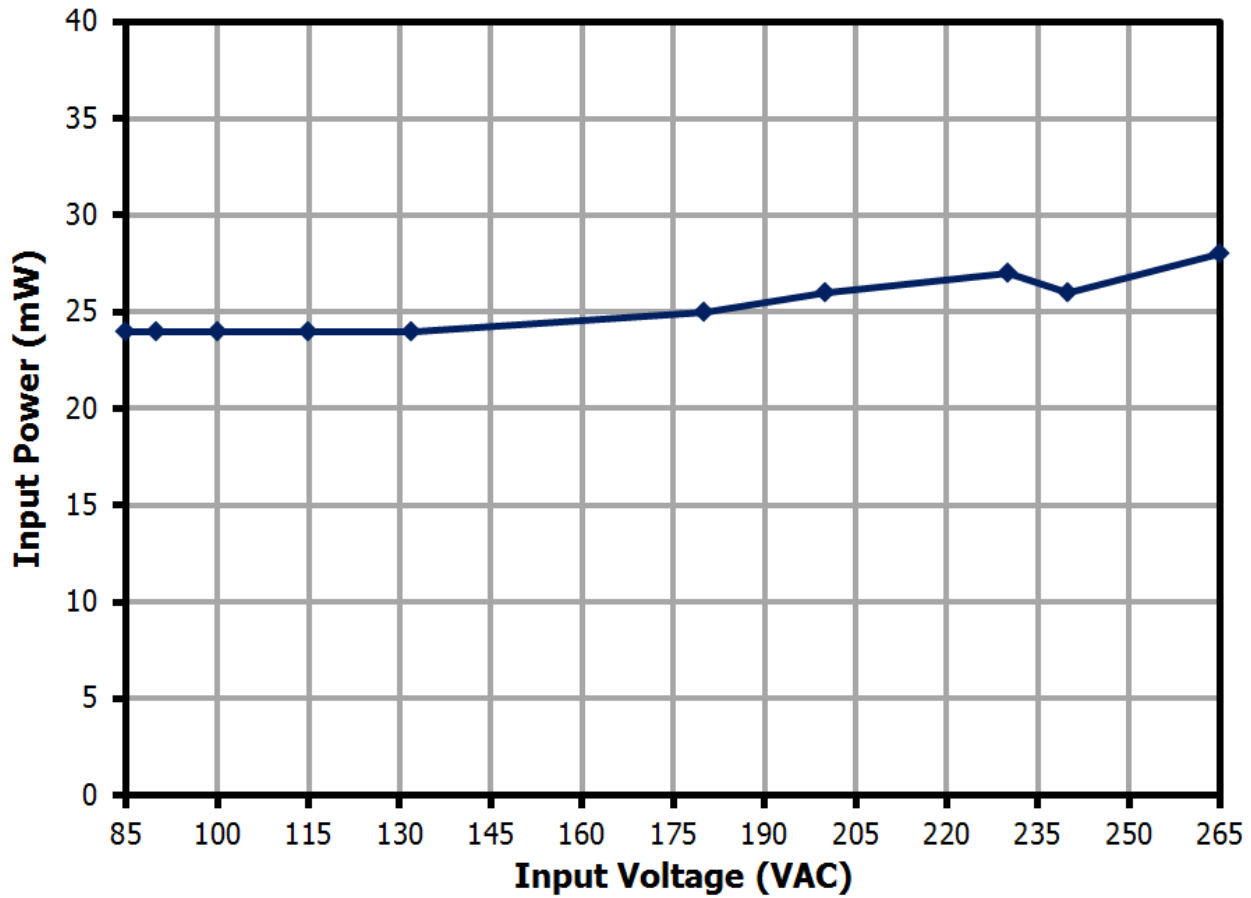

Figure 29 – No-Load Input Power vs. Input Line Voltage, Room Temperature.

10.6 Average Efficiency

10.6.1 Average Efficiency Requirements

		Test	Average	Average	Average	Average	10% Load	10% Load
		Effective	Now	2016	Jan-14	Jan-16	Jan-14	Jan-16
Output voltage	Model	Power [W]	Energy Star 2	New IESA2007	CoC v5 Tier 1	CoC v5 Tier 2	CoC v5 Tier 1	CoC v5 Tier 2
3	<6 V	15	77.21%	81.39%	79.05%	81.84%	69.50%	72.48%
5	<6 V	25	81.04%	84.25%	82.90%	85.00%	73.18%	75.47%
8	>6 V	40	85.93%	87.59%	87.69%	88.59%	77.69%	78.59%
15	>6 V	40	85.93%	87.59%	87.69%	88.59%	77.69%	78.59%
20	>6 V	40	85.93%	87.59%	87.69%	88.59%	77.69%	78.59%

10.7 Average and 10% Efficiency (On the Board) at 115 VAC Input

10.7.1 Output: 3 V

% Load	P _{OUT} (W)	Efficiency (%)	Average Efficiency (%)
100	15.52	84.04	84.92
75	11.56	85.07	
50	7.63	85.53	
25	3.77	85.05	
10	1.50	80.91	

10.7.2 Output: 5 V

% Load	P _{OUT} (W)	Efficiency (%)	Average Efficiency (%)
100	25.40	87.09	88.36
75	19.00	87.93	
50	12.61	88.79	
25	6.26	89.61	
10	2.49	89.17	

10.7.3 Output: 8 V

% Load	P _{OUT} (W)	Efficiency (%)	Average Efficiency (%)
100	40.39	88.35	89.32
75	30.24	89.06	
50	20.12	89.71	
25	10.01	90.15	
10	3.98	89.12	

10.7.4 Output: 15 V

% Load	P _{OUT} (W)	Efficiency (%)	Average Efficiency (%)
100	40.08	89.81	89.77
75	30.04	89.92	
50	19.99	90.01	
25	9.97	89.32	
10	3.97	85.81	

10.7.5 Output: 20 V

% Load	P _{OUT} (W)	Efficiency (%)	Average Efficiency (%)
100	40.12	89.71	89.20
75	30.06	89.62	
50	20.02	89.46	
25	9.99	88.01	
10	3.98	83.04	

10.8 Average and 10% Efficiency (On the Board) at 230 VAC Input

10.8.1 Output: 3 V

% Load	P _{OUT} (W)	Efficiency (%)	Average Efficiency (%)
100	15.65	84.02	84.04
75	11.65	84.75	
50	7.68	84.77	
25	3.79	82.61	
10	1.50	77.12	

10.8.2 Output: 5 V

% Load	P _{OUT} (W)	Efficiency (%)	Average Efficiency (%)
100	25.51	87.89	88.64
75	19.06	88.59	
50	12.64	89.20	
25	6.26	88.88	
10	2.49	86.96	

10.8.3 Output: 8 V

% Load	P _{OUT} (W)	Efficiency (%)	Average Efficiency (%)
100%	40.52	89.49	89.99
75%	30.33	90.09	
50%	20.15	90.39	
25%	10.02	90.01	
10%	3.99	87.86	

10.8.4 Output: 15 V

% Load	P_{OUT} (W)	Efficiency (%)	Average Efficiency (%)
100	40.14	91.05	90.53
75	30.08	90.98	
50	20.01	90.75	
25	9.98	89.33	
10	3.98	84.78	

10.8.5 Output: 20 V

% Load	P_{OUT} (W)	Efficiency (%)	Average Efficiency (%)
100	40.15	90.95	89.98
75	30.09	90.71	
50	20.04	90.23	
25	9.99	88.04	
10	3.98	82.11	

10.9 CV/CC

10.9.1 Output: 3 V (CC Programmed to 5.1 A, V_{KP} Programmed to 7 V)

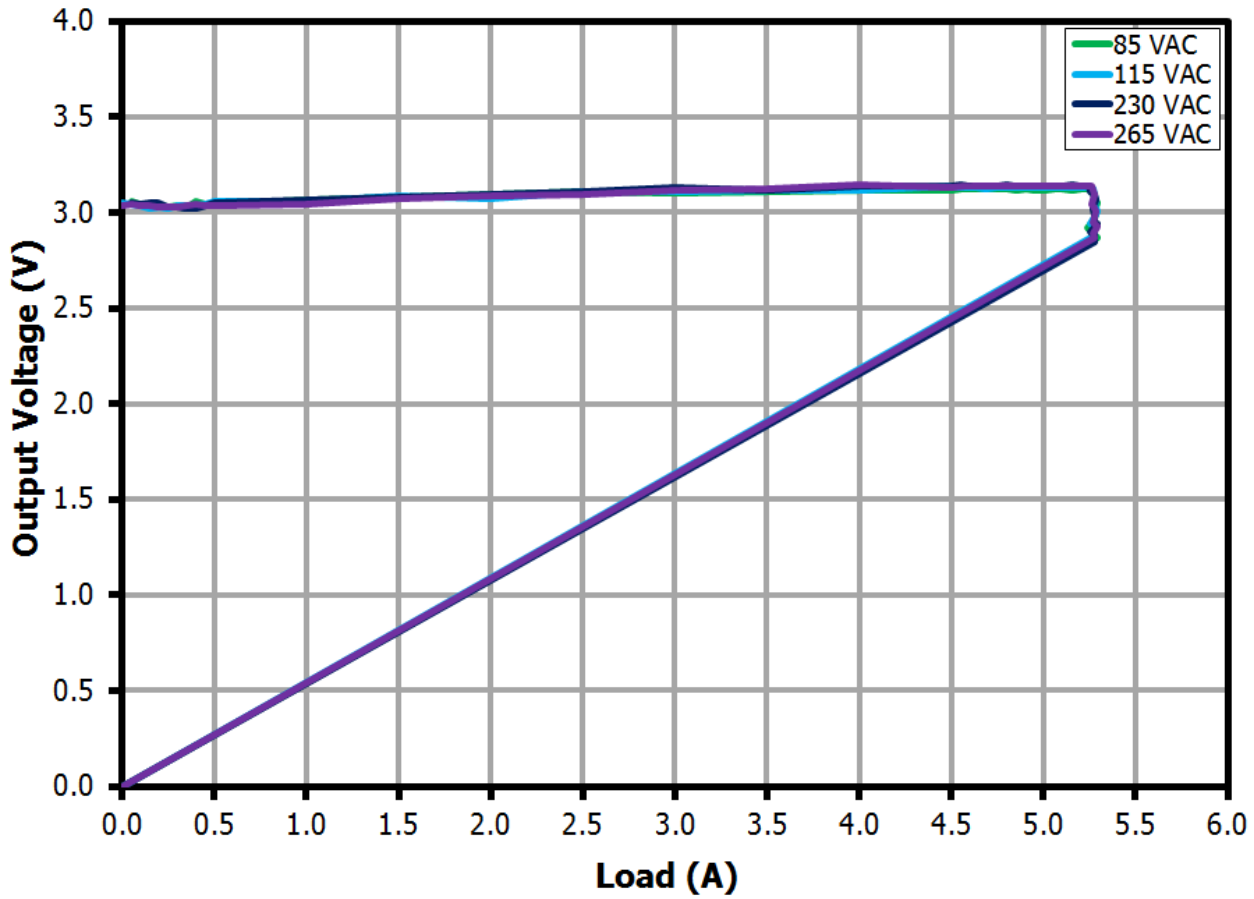

Figure 30 – Output Voltage vs. Output Current, Room Temperature.

10.9.2 Output: 5 V (CC Programmed to 5.1 A, V_{KP} Programmed to 7 V)

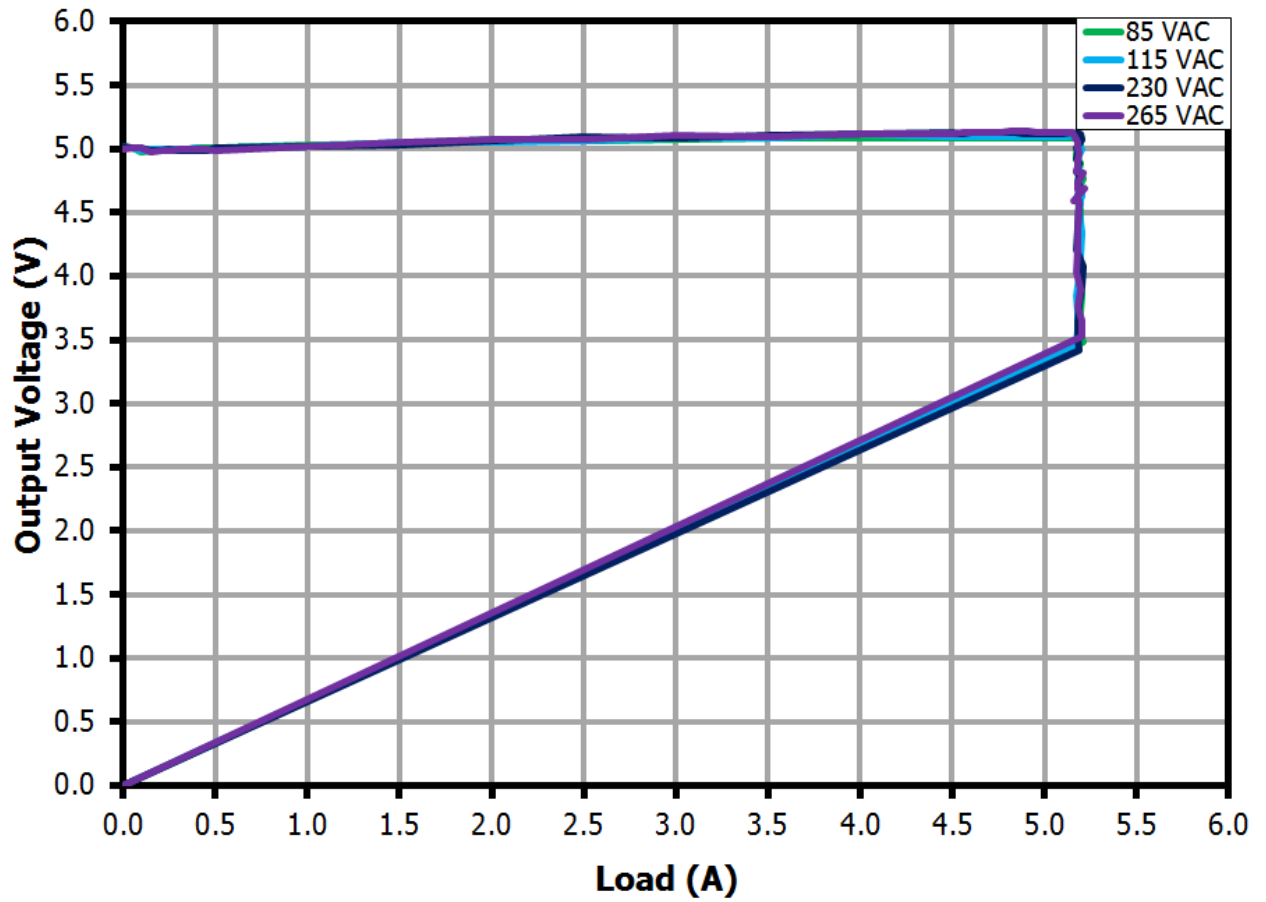

Figure 31 – Output Voltage vs. Output Current, Room Temperature.



10.9.3 Output: 8 V (CC Programmed to 5.1 A, V_{KP} Programmed to 7 V)

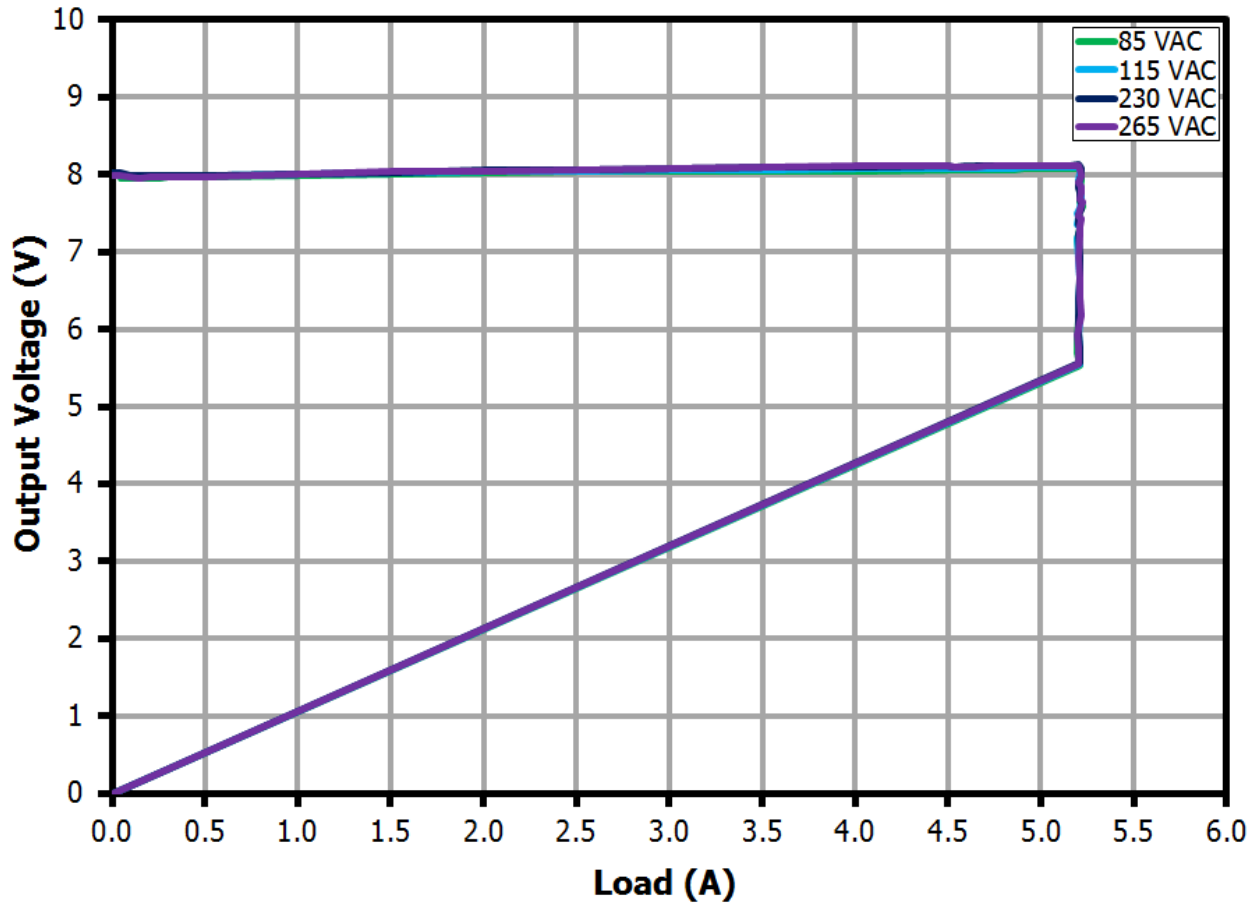

Figure 32 – Output Voltage vs. Output Current, Room Temperature.

10.9.4 Output: 15 V (CC Programmed to 5.1 A, V_{KP} Programmed to 7 V)

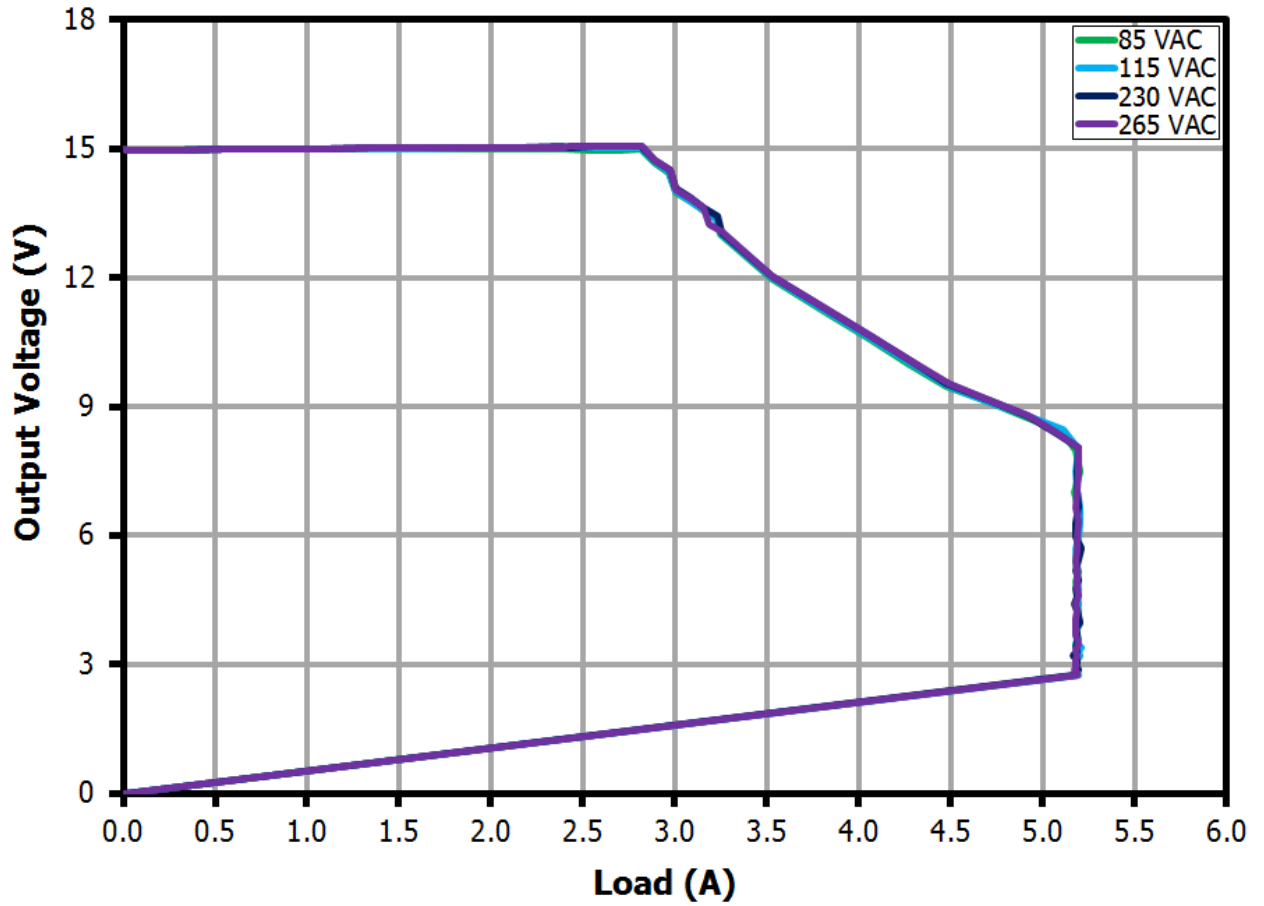

Figure 33 – Output Voltage vs. Output Current, Room Temperature.



10.9.5 Output: 20 V (CC Programmed to 5.1 A, V_{KP} Programmed to 7 V)

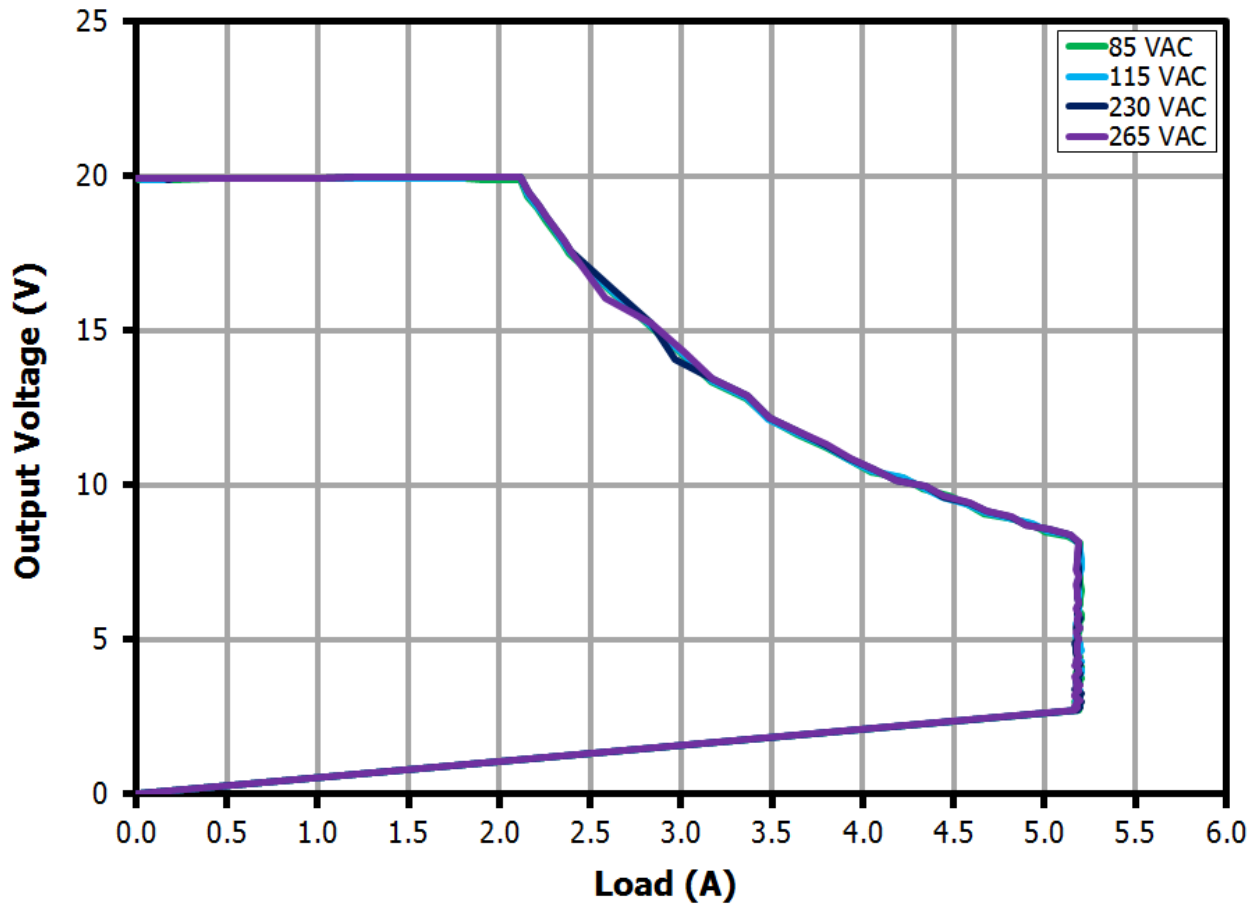

Figure 34 – Output Voltage vs. Output Current, Room Temperature.

11 Thermal Performance in Open Case

11.1 85 VAC Input 3 V / 5 A



Figure 35 – Top Components, Ambient = 27 °C.
 Bx1: SR FET, PCB = 51.2 °C.
 Bx2: Transformer = 50.4 °C.
 Bx3: Primary Snubber = 44.9 °C.
 Bx4: Thermistor = 54.7 °C.
 Bx5: Bridge Diodes = 46.7 °C.
 E1: Output Capacitor = 41.6 °C.
 E2: Input Capacitor = 41.6 °C.

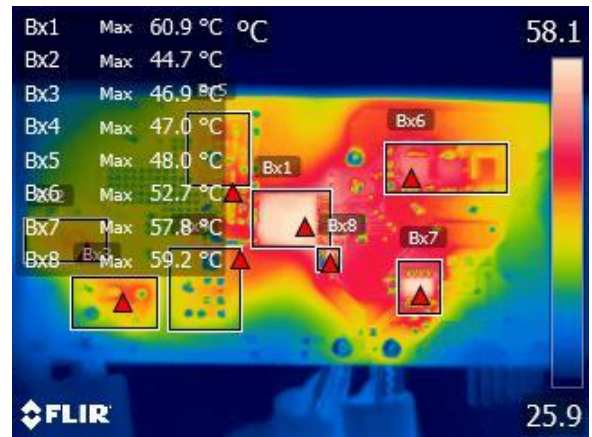

Figure 36 – Bottom Components, Ambient = 27 °C.
 Bx1: InnoSwitch3-Pro = 60.9 °C.
 Bx2: Bridge Diodes, PCB = 44.7 °C.
 Bx3: Thermistor, PCB = 46.9 °C.
 Bx4: Primary Snubber = 47.0 °C.
 Bx5: Auxiliary Circuit = 48.0 °C.
 Bx6: SR FET = 52.7 °C.
 Bx7: Pass FET = 57.8 °C.
 Bx8: Current Sense Resistor = 59.2 °C.

11.2 265 VAC Input 3 V / 5 A

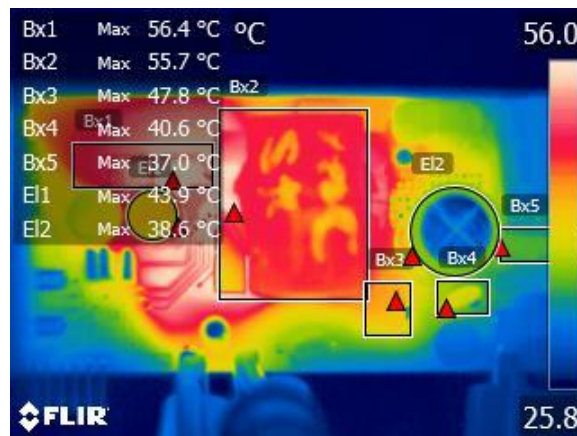

Figure 37 – Top Components, Ambient = 27 °C.
 Bx1: SR FET, PCB = 56.4 °C.
 Bx2: Transformer = 55.7 °C.
 Bx3: Primary Snubber = 47.8 °C.
 Bx4: Thermistor = 40.6 °C.
 Bx5: Bridge Diodes = 37.0 °C.
 E1: Output Capacitor = 43.9 °C.
 E2: Input Capacitor = 38.6 °C.

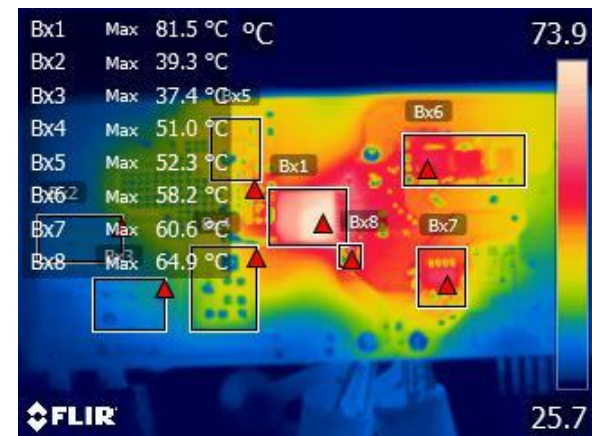

Figure 38 – Bottom Components, Ambient = 27 °C.
 Bx1: InnoSwitch3-Pro = 81.5 °C.
 Bx2: Bridge Diodes, PCB = 39.3 °C.
 Bx3: Thermistor, PCB = 37.4 °C.
 Bx4: Primary Snubber = 51.0 °C.
 Bx5: Auxiliary Circuit = 52.3 °C.
 Bx6: SR FET = 58.2 °C.
 Bx7: Pass FET = 60.6 °C.
 Bx8: Current Sense Resistor = 64.9 °C.

11.3 85 VAC Input 5 V / 5 A

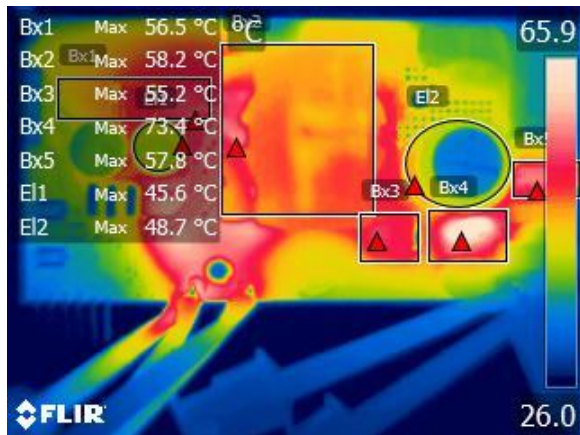

Figure 39 – Top Components, Ambient = 27 °C.
 Bx1: SR FET, PCB = 56.5 °C.
 Bx2: Transformer = 58.2 °C.
 Bx3: Primary Snubber = 55.2 °C.
 Bx4: Thermistor = 73.4 °C.
 Bx5: Bridge Diodes = 57.8 °C.
 E11: Output Capacitor = 45.6 °C.
 E12: Input Capacitor = 48.7 °C.

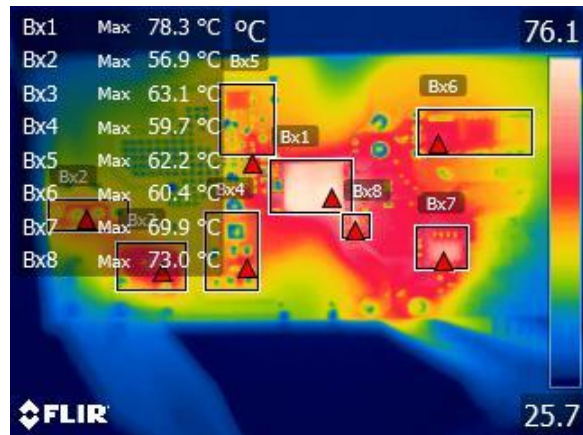

Figure 40 – Bottom Components, Ambient = 27 °C.
 Bx1: InnoSwitch3-Pro = 78.3 °C.
 Bx2: Bridge Diodes, PCB = 56.9 °C.
 Bx3: Thermistor, PCB = 63.1 °C.
 Bx4: Primary Snubber = 59.7 °C.
 Bx5: Auxiliary Circuit = 62.2 °C.
 Bx6: SR FET = 60.4 °C.
 Bx7: Pass FET = 69.9 °C.
 Bx8: Current Sense Resistor = 73.0 °C.

11.4 265 VAC Input 5 V / 5 A

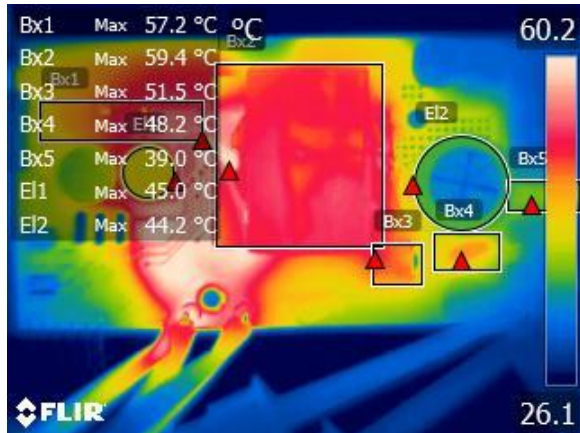

Figure 41 – Top Components, Ambient = 27 °C.
 Bx1: SR FET, PCB = 57.2 °C.
 Bx2: Transformer = 59.4 °C.
 Bx3: Primary Snubber = 51.5 °C.
 Bx4: Thermistor = 48.2 °C.
 Bx5: Bridge Diodes = 39.0 °C.
 E11: Output Capacitor = 45.0 °C.
 E12: Input Capacitor = 44.2 °C.

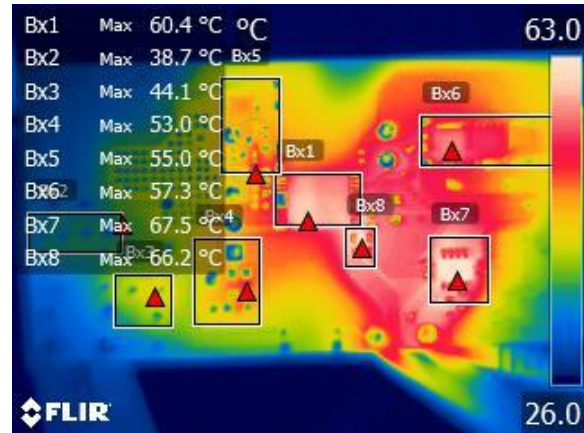

Figure 42 – Bottom Components, Ambient = 27 °C.
 Bx1: InnoSwitch3-Pro = 60.4 °C.
 Bx2: Bridge Diodes, PCB = 38.7 °C.
 Bx3: Thermistor, PCB = 44.1 °C.
 Bx4: Primary Snubber = 53.0 °C.
 Bx5: Auxiliary Circuit = 55.0 °C.
 Bx6: SR FET = 57.3 °C.
 Bx7: Pass FET = 67.5 °C.
 Bx8: Current Sense Resistor = 66.2 °C.

11.5 85 VAC Input 8 V / 5 A

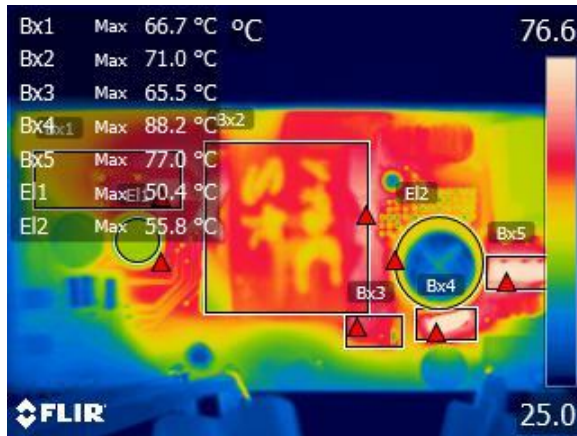

Figure 43 – Top Components, Ambient = 27 °C.
 Bx1: SR FET, PCB = 66.7 °C.
 Bx2: Transformer = 71.0 °C.
 Bx3: Primary Snubber = 65.5 °C.
 Bx4: Thermistor = 88.2 °C.
 Bx5: Bridge Diodes = 77.0 °C.
 E1: Output Capacitor = 50.4 °C.
 E2: Input Capacitor = 55.8 °C.

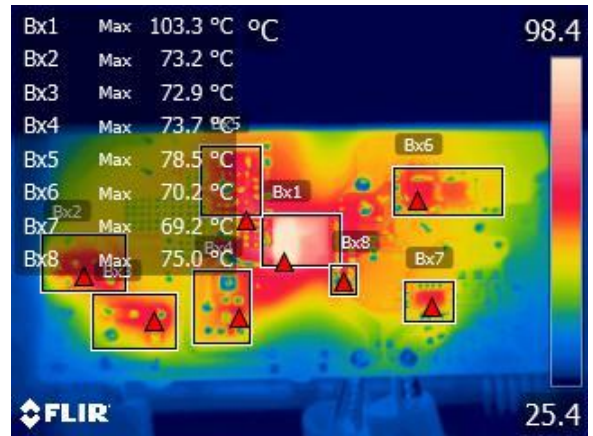

Figure 44 – Bottom Components, Ambient = 27 °C.
 Bx1: InnoSwitch3-Pro = 103.3 °C.
 Bx2: Bridge Diodes, PCB = 73.2 °C.
 Bx3: Thermistor, PCB = 72.9 °C.
 Bx4: Primary Snubber = 73.7 °C.
 Bx5: Auxiliary Circuit = 78.5 °C.
 Bx6: SR FET = 70.2 °C.
 Bx7: Pass FET = 69.2 °C.
 Bx8: Current Sense Resistor = 75.0 °C.

11.6 265 VAC Input 8 V / 5 A

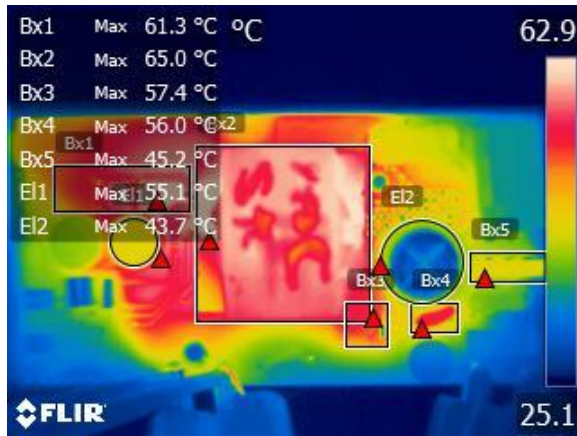

Figure 45 – Top Components, Ambient = 27 °C.
 Bx1: SR FET, PCB = 61.3 °C.
 Bx2: Transformer = 65.0 °C.
 Bx3: Primary Snubber = 57.4 °C.
 Bx4: Thermistor = 56.0 °C.
 Bx5: Bridge Diodes = 45.2 °C.
 E1: Output Capacitor = 55.1 °C.
 E2: Input Capacitor = 43.7 °C.

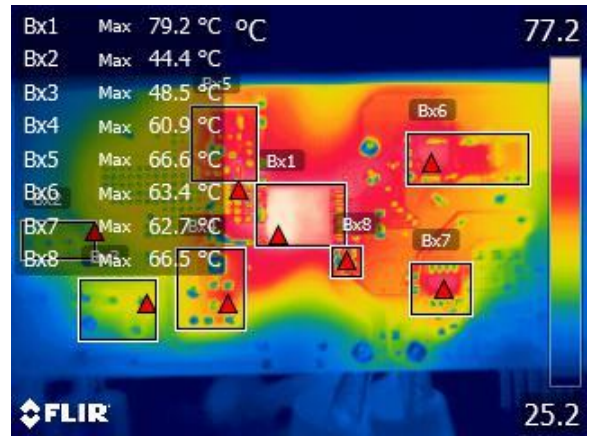

Figure 46 – Bottom Components, Ambient = 27 °C.
 Bx1: InnoSwitch3-Pro = 79.2 °C.
 Bx2: Bridge Diodes, PCB = 44.4 °C.
 Bx3: Thermistor, PCB = 48.5 °C.
 Bx4: Primary Snubber = 60.9 °C.
 Bx5: Auxiliary Circuit = 66.6 °C.
 Bx6: SR FET = 63.4 °C.
 Bx7: Pass FET = 62.7 °C.
 Bx8: Current Sense Resistor = 66.5 °C.

11.7 85 VAC Input 15 V / 2.666 A

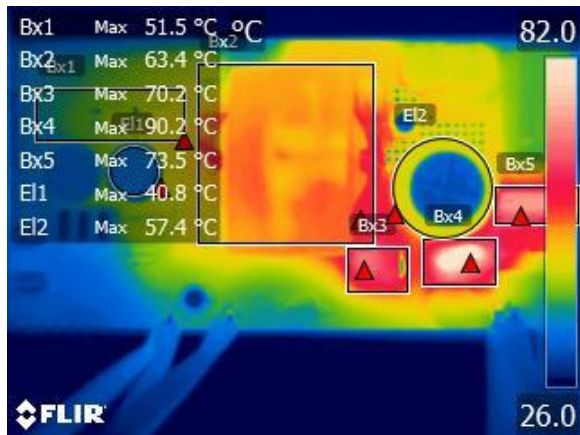

Figure 47 – Top Components, Ambient = 27 °C.
 Bx1: SR FET, PCB = 51.5 °C.
 Bx2: Transformer = 63.4 °C.
 Bx3: Primary Snubber = 70.2 °C.
 Bx4: Thermistor = 90.2 °C.
 Bx5: Bridge Diodes = 73.5 °C.
 E1: Output Capacitor = 40.8 °C.
 E2: Input Capacitor = 57.4 °C.

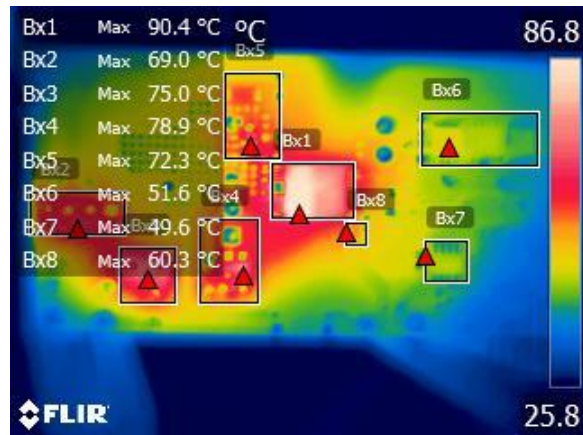

Figure 48 – Bottom Components, Ambient = 27 °C.
 Bx1: InnoSwitch3-Pro = 90.4 °C.
 Bx2: Bridge Diodes, PCB = 69.0 °C.
 Bx3: Thermistor, PCB = 75.0 °C.
 Bx4: Primary Snubber = 78.9 °C.
 Bx5: Auxiliary Circuit = 72.3 °C.
 Bx6: SR FET = 51.6 °C.
 Bx7: Pass FET = 49.6 °C.
 Bx8: Current Sense Resistor = 60.3 °C.

11.8 265 VAC Input 15 V / 2.666 A

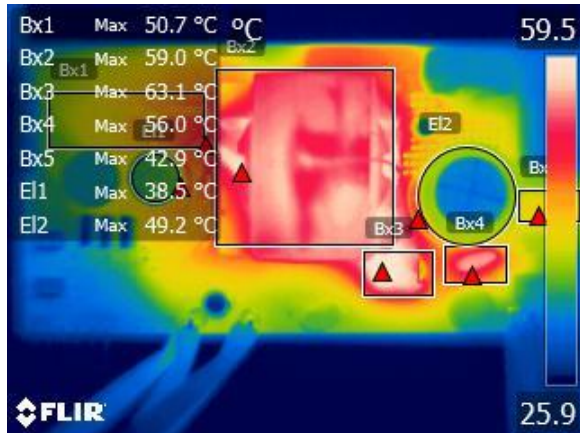

Figure 49 – Top Components, Ambient = 27 °C.
 Bx1: SR FET, PCB = 50.7 °C.
 Bx2: Transformer = 59.0 °C.
 Bx3: Primary Snubber = 63.1 °C.
 Bx4: Thermistor = 56.0 °C.
 Bx5: Bridge Diodes = 42.9 °C.
 E1: Output Capacitor = 38.5 °C.
 E2: Input Capacitor = 49.2 °C.



Figure 50 – Bottom Components, Ambient = 27 °C.
 Bx1: InnoSwitch3-Pro = 72.7 °C.
 Bx2: Bridge Diodes, PCB = 43.5 °C.
 Bx3: Thermistor, PCB = 52.0 °C.
 Bx4: Primary Snubber = 73.8 °C.
 Bx5: Auxiliary Circuit = 63.9 °C.
 Bx6: SR FET = 53.0 °C.
 Bx7: Pass FET = 49.4 °C.
 Bx8: Current Sense Resistor = 56.0 °C.

11.9 85 VAC Input 20 V / 2 A

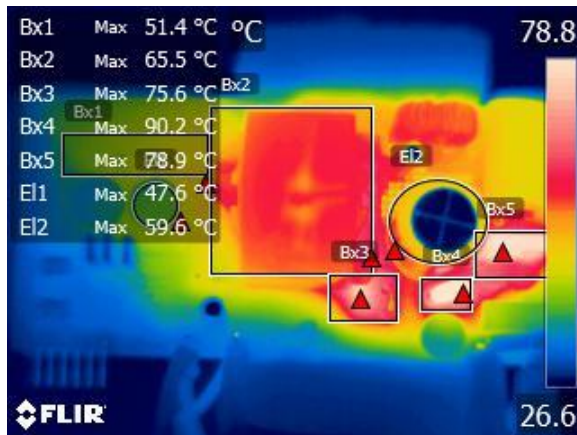

Figure 51 – Top Components, Ambient = 27 °C.
 Bx1: SR FET, PCB = 51.4 °C.
 Bx2: Transformer = 65.5 °C.
 Bx3: Primary Snubber = 75.6 °C.
 Bx4: Thermistor = 90.2 °C.
 Bx5: Bridge Diodes = 78.9 °C.
 E1: Output Capacitor = 47.6 °C.
 E2: Input Capacitor = 59.6 °C.

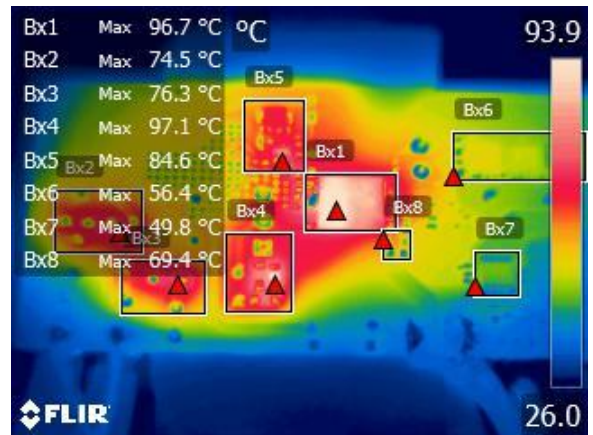

Figure 52 – Bottom Components, Ambient = 27 °C.
 Bx1: InnoSwitch3-Pro = 96.7 °C.
 Bx2: Bridge Diodes, PCB = 74.5 °C.
 Bx3: Thermistor, PCB = 76.3 °C.
 Bx4: Primary Snubber = 97.1 °C.
 Bx5: Auxiliary Circuit = 84.6 °C.
 Bx6: SR FET = 56.4 °C.
 Bx7: Pass FET = 49.8 °C.
 Bx8: Current Sense Resistor = 69.4 °C.

11.10 265 VAC Input 20 V / 2 A

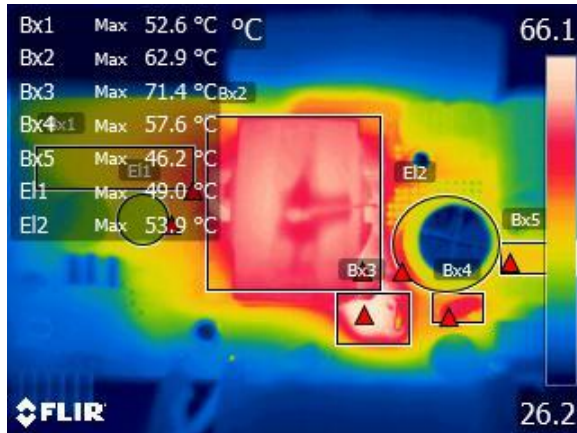

Figure 53 – Top Components, Ambient = 27 °C.
 Bx1: SR FET, PCB = 52.6 °C.
 Bx2: Transformer = 62.9 °C.
 Bx3: Primary Snubber = 71.4 °C.
 Bx4: Thermistor = 57.6 °C.
 Bx5: Bridge Diodes = 46.2 °C.
 E1: Output Capacitor = 49.0 °C.
 E2: Input Capacitor = 53.9 °C.

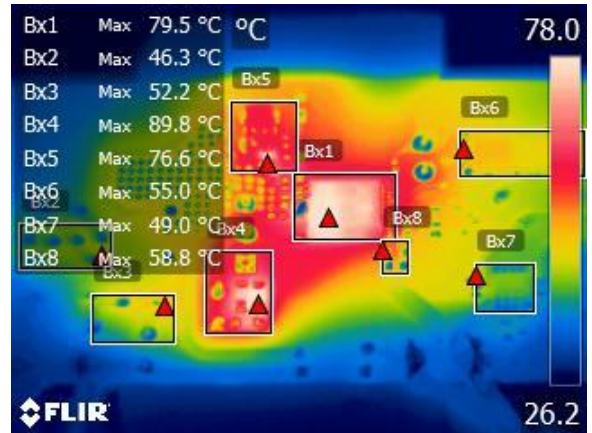

Figure 54 – Bottom Components, Ambient = 27 °C.
 Bx1: InnoSwitch3-Pro = 79.5 °C.
 Bx2: Bridge Diodes, PCB = 46.3 °C.
 Bx3: Thermistor, PCB = 52.2 °C.
 Bx4: Primary Snubber = 89.8 °C.
 Bx5: Auxiliary Circuit = 76.6 °C.
 Bx6: SR FET = 55.0 °C.
 Bx7: Pass FET = 49.0 °C.
 Bx8: Current Sense Resistor = 58.8 °C.

12 Waveforms

12.1 Load Transient Response (PCB End)

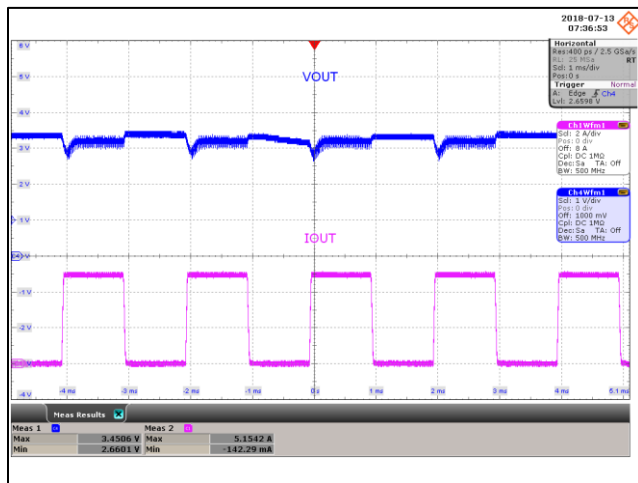

Figure 55 – Transient Response.
 85 VAC, 3.0 V, 0 - 5 A Load Step.
 V_{MIN} : 2.66 V, V_{MAX} : 3.45 V.
 Upper: V_{OUT} , 1 V / div., 1 ms / div.
 Lower: I_{LOAD} , 2 A / div.

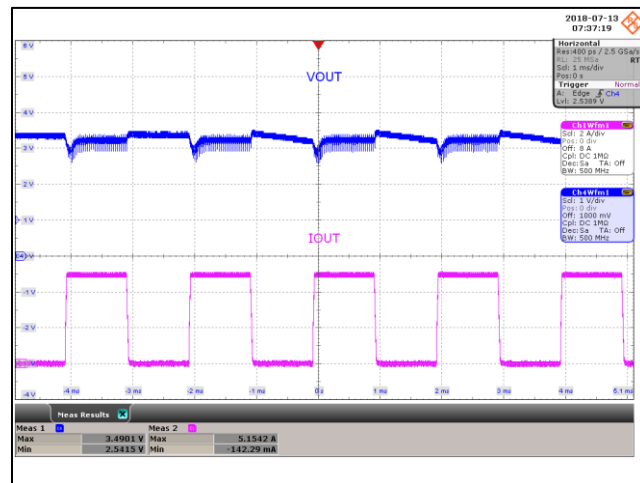

Figure 56 – Transient Response.
 265 VAC, 3.0 V, 0 - 5 A Load Step.
 V_{MIN} : 2.54 V, V_{MAX} : 3.49 V.
 Upper: V_{OUT} , 1 V / div., 1 ms / div.
 Lower: I_{LOAD} , 2 A / div.

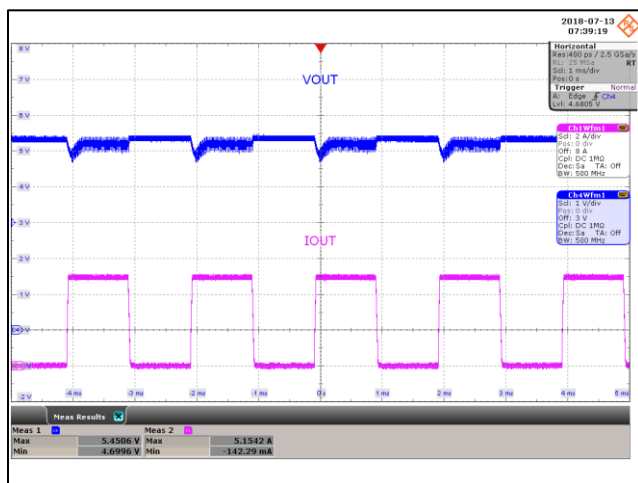

Figure 57 – Transient Response.
 85 VAC, 5.0 V, 0 - 5 A Load Step.
 V_{MIN} : 4.69 V, V_{MAX} : 5.45 V.
 Upper: V_{OUT} , 1 V / div., 1 ms / div.
 Lower: I_{LOAD} , 2 A / div.

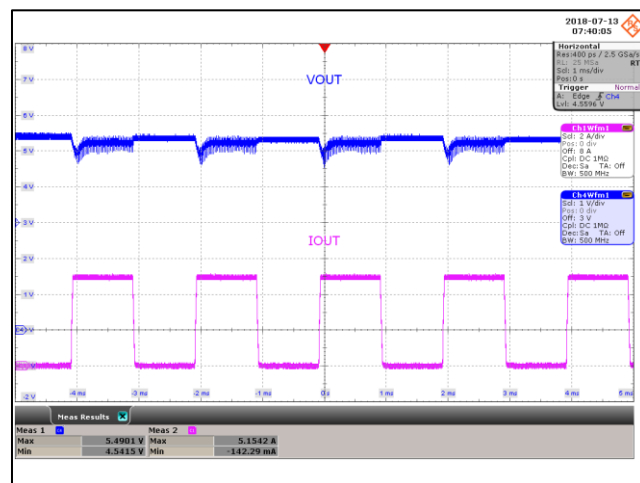

Figure 58 – Transient Response.
 265 VAC, 5.0 V, 0 - 5 A Load Step.
 V_{MIN} : 4.54 V, V_{MAX} : 5.49 V.
 Upper: V_{OUT} , 1 V / div., 1 ms / div.
 Lower: I_{LOAD} , 2 A / div.

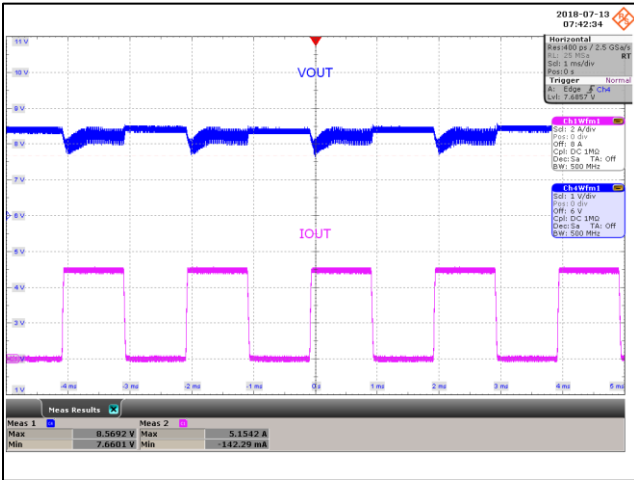

Figure 59 – Transient Response.
 85 VAC, 8.0 V, 0 - 5 A Load Step.
 V_{MIN} : 7.66 V, V_{MAX} : 8.56 V.
 Upper: V_{OUT} , 1 V / div., 1 ms / div.
 Lower: I_{LOAD} , 2 A / div.

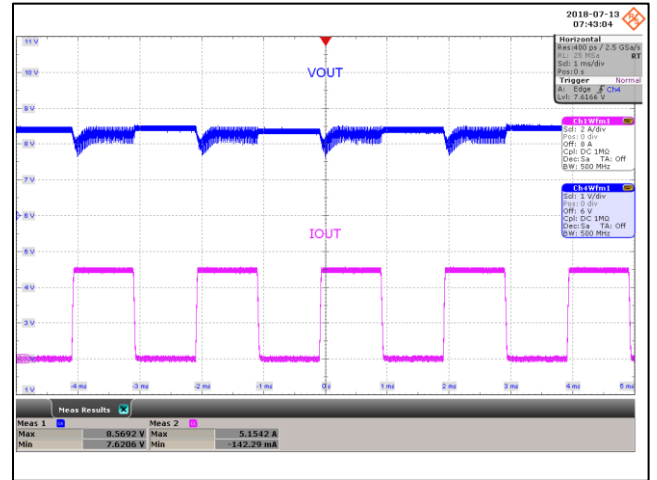

Figure 60 – Transient Response.
 265 VAC, 8.0 V, 0 - 5 A Load Step.
 V_{MIN} : 7.62 V, V_{MAX} : 8.56 V.
 Upper: V_{OUT} , 1 V / div., 1 ms / div.
 Lower: I_{LOAD} , 2 A / div.

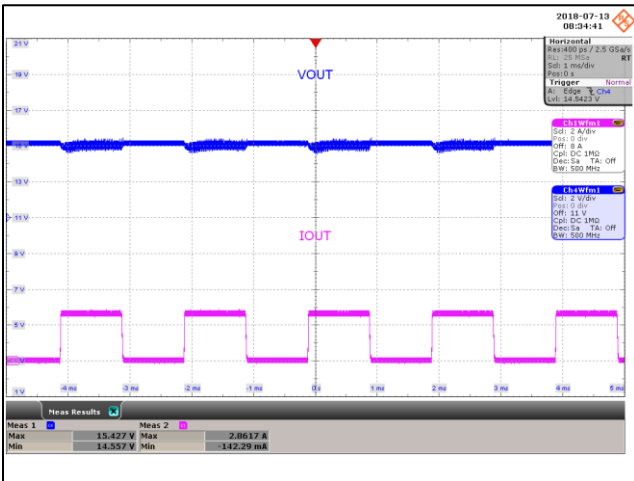

Figure 61 – Transient Response.
 85 VAC, 15.0 V, 0 - 2.66 A Load Step.
 V_{MIN} : 14.55 V, V_{MAX} : 15.42 V.
 Upper: V_{OUT} , 2 V / div., 1 ms / div.
 Lower: I_{LOAD} , 2 A / div.

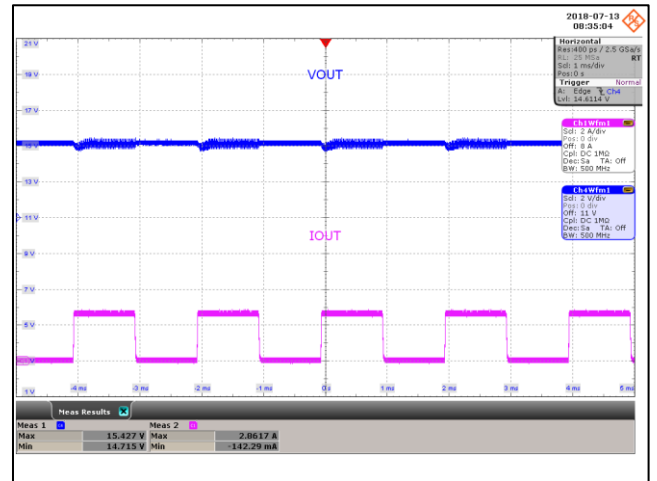

Figure 62 – Transient Response.
 265 VAC, 15.0 V, 0 - 2.66 A Load Step.
 V_{MIN} : 14.71 V, V_{MAX} : 15.42 V.
 Upper: V_{OUT} , 2 V / div., 1 ms / div.
 Lower: I_{LOAD} , 2 A / div.



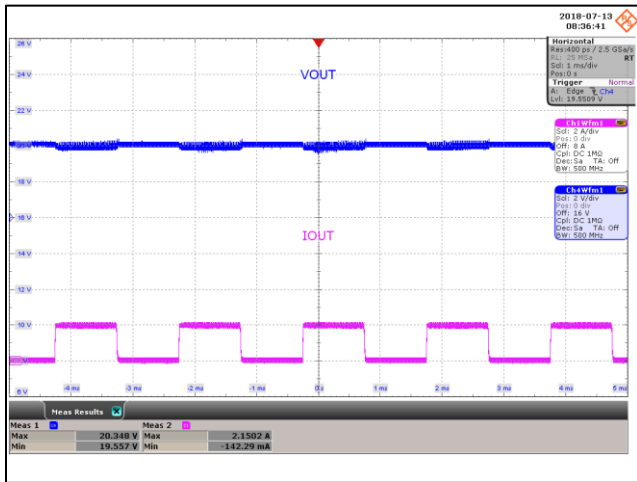

Figure 63 – Transient Response.
 85 VAC, 20.0 V, 0 - 2 A Load Step.
 V_{MIN} : 19.55 V, V_{MAX} : 20.34 V.
 Upper: V_{OUT} , 2 V / div., 1 ms / div.
 Lower: I_{LOAD} , 2 A / div.

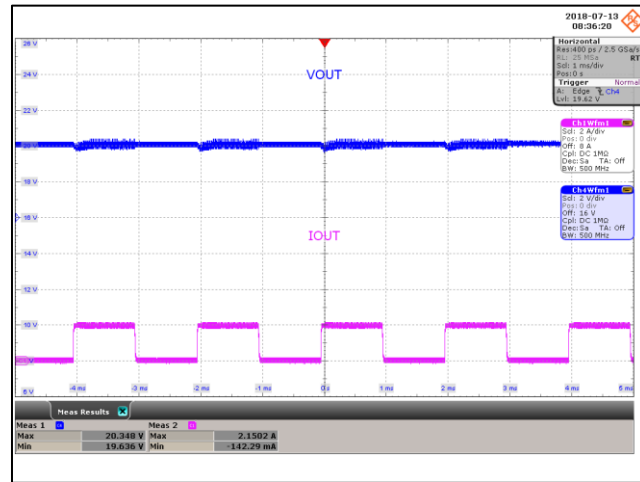

Figure 64 – Transient Response.
 265 VAC, 20.0 V, 0 - 2 A Load Step.
 V_{MIN} : 19.63 V, V_{MAX} : 20.34 V.
 Upper: V_{OUT} , 2 V / div., 1 ms / div.
 Lower: I_{LOAD} , 2 A / div.

12.2 Switching Waveforms

12.2.1 Drain Voltage and Current

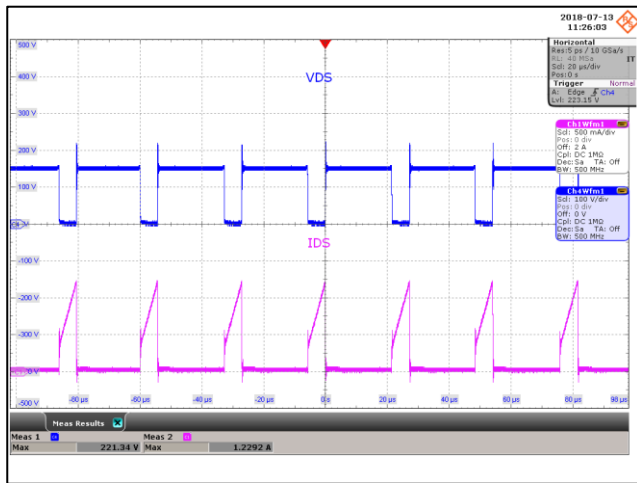

Figure 65 – Drain Voltage and Current Waveforms.
 85 VAC, 3.0 V, 5 A Load (221 V_{MAX}).
 Upper: V_{DRAIN}, 100 V / div., 20 μs / div.
 Lower: I_{DRAIN}, 500 mA / div.

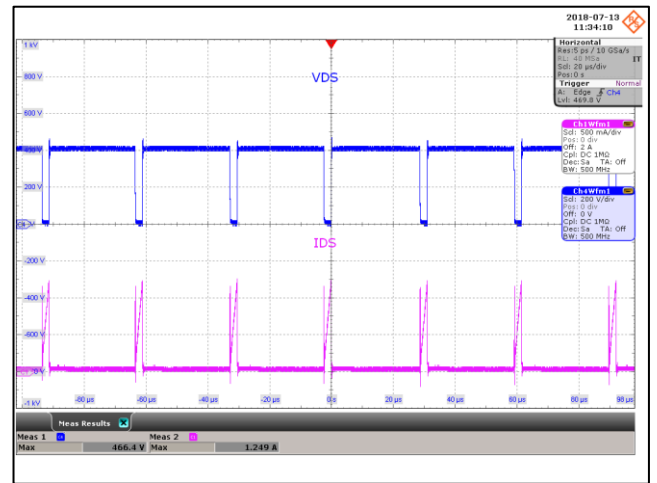

Figure 66 – Drain Voltage and Current Waveforms.
 265 VAC, 3.0 V, 5 A Load (466 V_{MAX}).
 Upper: V_{DRAIN}, 200 V / div., 20 μs / div.
 Lower: I_{DRAIN}, 500 mA / div.

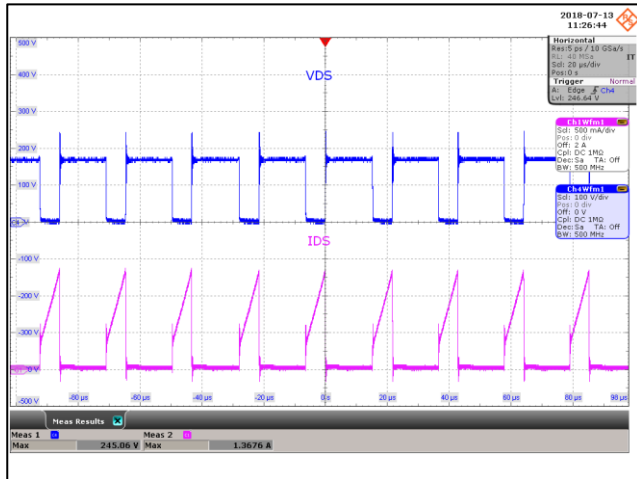

Figure 67 – Drain Voltage and Current Waveforms.
 85 VAC, 5.0 V, 5 A Load (245 V_{MAX}).
 Upper: V_{DRAIN}, 100 V / div., 20 μs / div.
 Lower: I_{DRAIN}, 500 mA / div.

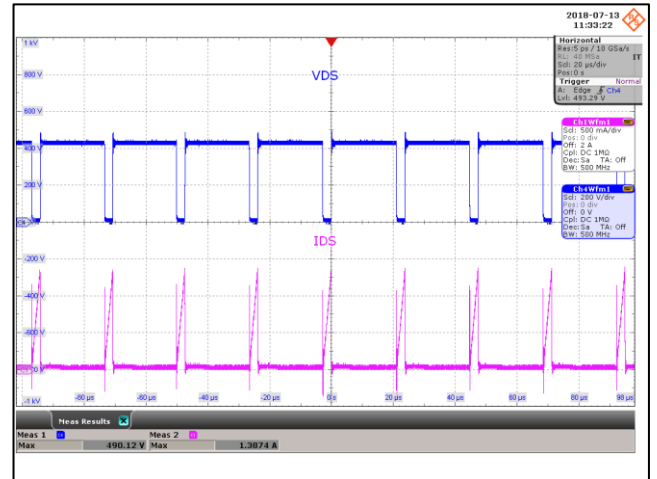

Figure 68 – Drain Voltage and Current Waveforms.
 265 VAC, 5.0 V, 5 A Load (490 V_{MAX}).
 Upper: V_{DRAIN}, 200 V / div., 20 μs / div.
 Lower: I_{DRAIN}, 500 mA / div.



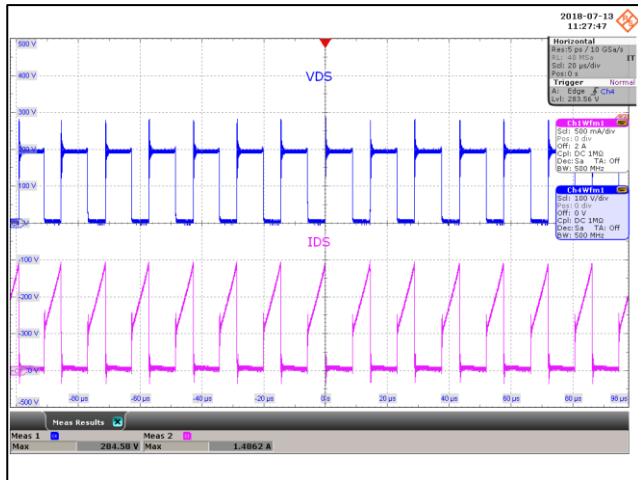

Figure 69 – Drain Voltage and Current Waveforms.
 85 VAC, 8.0 V, 5 A Load (284 V_{MAX}).
 Upper: V_{DRAIN}, 100 V / div., 20 μs / div.
 Lower: I_{DRAIN}, 500 mA / div.

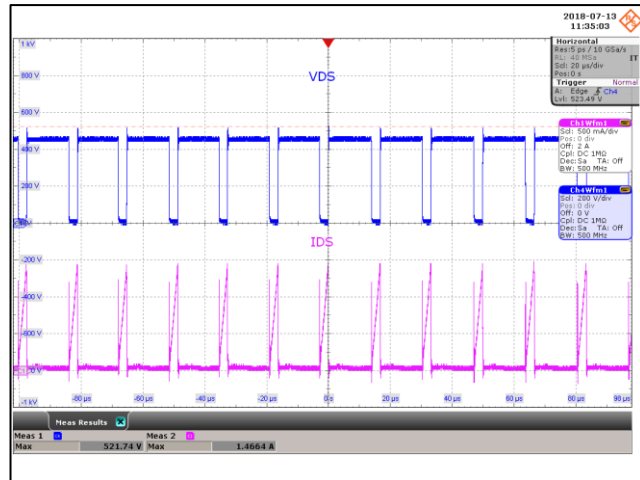

Figure 70 – Drain Voltage and Current Waveforms.
 265 VAC, 8.0 V, 5 A Load (521 V_{MAX}).
 Upper: V_{DRAIN}, 200 V / div., 20 μs / div.
 Lower: I_{DRAIN}, 500 mA / div.

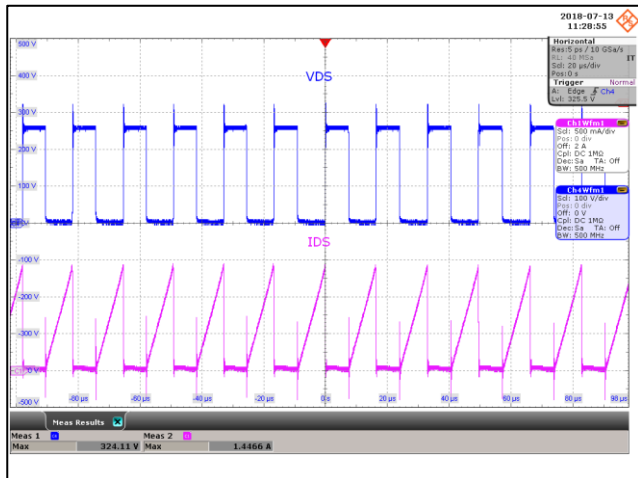

Figure 71 – Drain Voltage and Current Waveforms.
 85 VAC, 15.0 V, 2.66 A Load (324 V_{MAX}).
 Upper: V_{DRAIN}, 100 V / div., 20 μs / div.
 Lower: I_{DRAIN}, 500 mA / div.

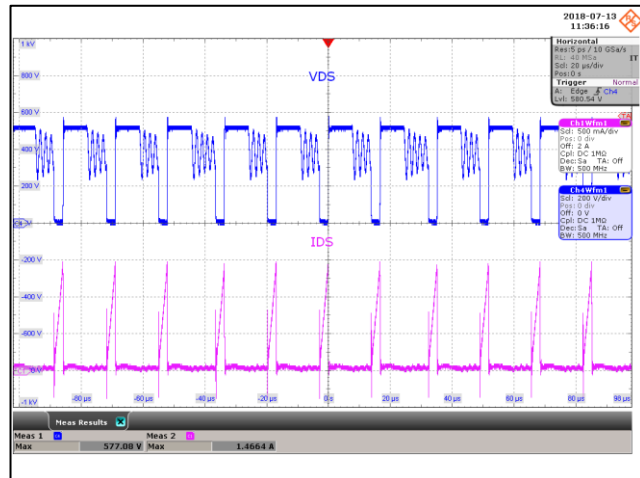

Figure 72 – Drain Voltage and Current Waveforms.
 265 VAC, 15.0 V, 2.66 A Load (577 V_{MAX}).
 Upper: V_{DRAIN}, 200 V / div., 20 μs / div.
 Lower: I_{DRAIN}, 500 mA / div.

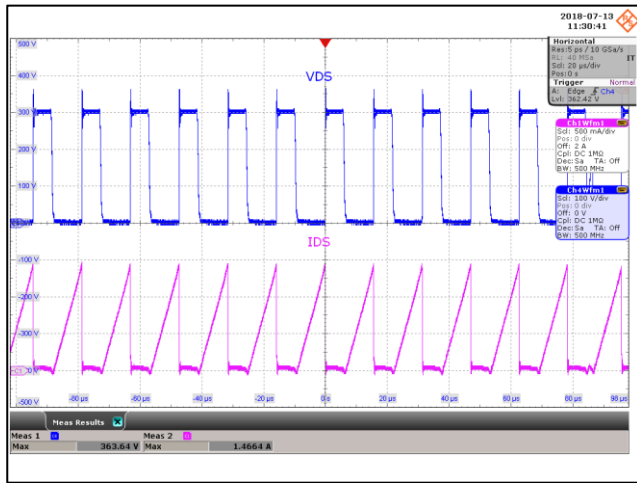

Figure 73 – Drain Voltage and Current Waveforms.
85 VAC, 20.0 V, 2.0 A Load (363 V_{MAX}).
Upper: V_{DRAIN}, 100 V / div., 20 μs / div.
Lower: I_{DRAIN}, 500 mA / div.

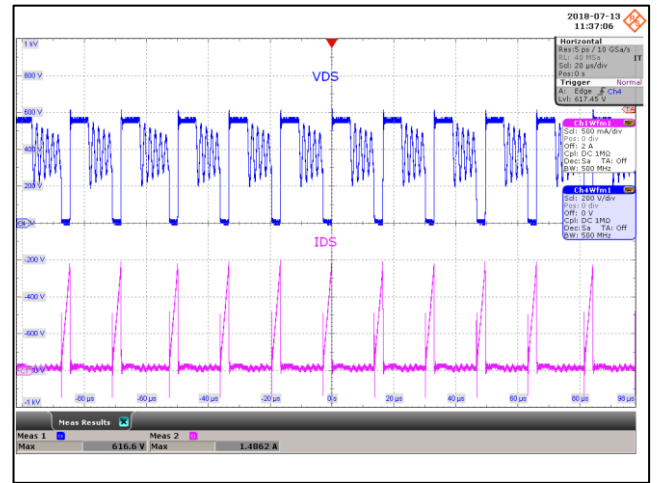

Figure 74 – Drain Voltage and Current Waveforms.
265 VAC, 20.0 V, 2.0 A Load (616 V_{MAX}).
Upper: V_{DRAIN}, 200 V / div., 20 μs / div.
Lower: I_{DRAIN}, 500 mA / div.

12.2.2 Drain Voltage and Current Start-up

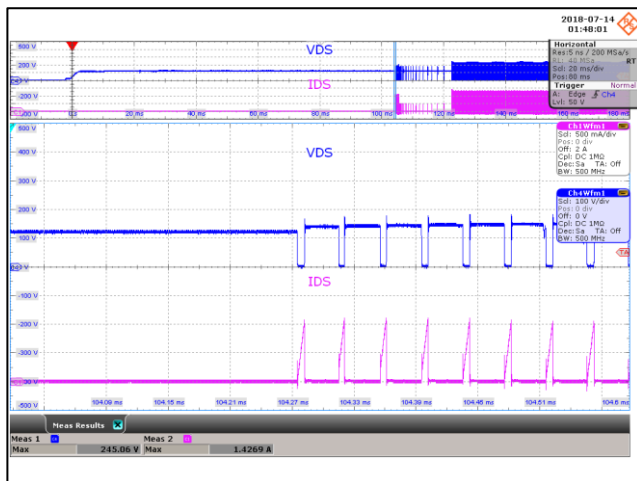

Figure 75 – Drain Voltage and Current Waveforms.
85 VAC, 5.0 V, 5.0 A Load (245 V_{MAX}).
Upper: V_{DRAIN}, 100 V / div., 20 ms / div.
Lower: I_{DRAIN}, 500 mA / div.

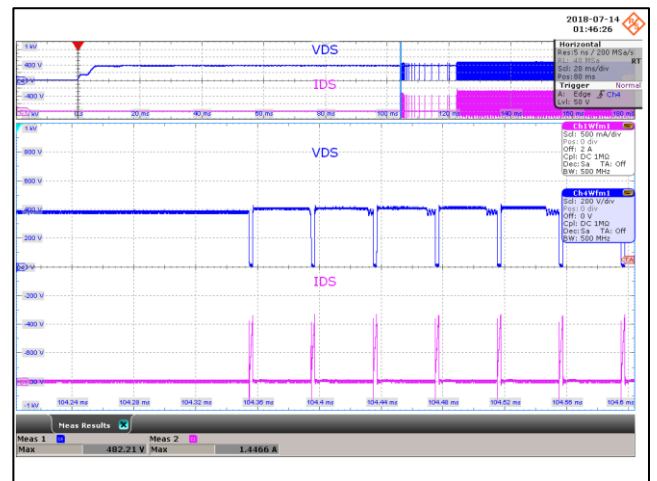

Figure 76 – Drain Voltage and Current Waveforms.
265 VAC, 5.0 V, 5.0 A Load (482 V_{MAX}).
Upper: V_{DRAIN}, 200 V / div., 20 ms / div.
Lower: I_{DRAIN}, 500 mA / div.



12.2.3 SR FET Voltage

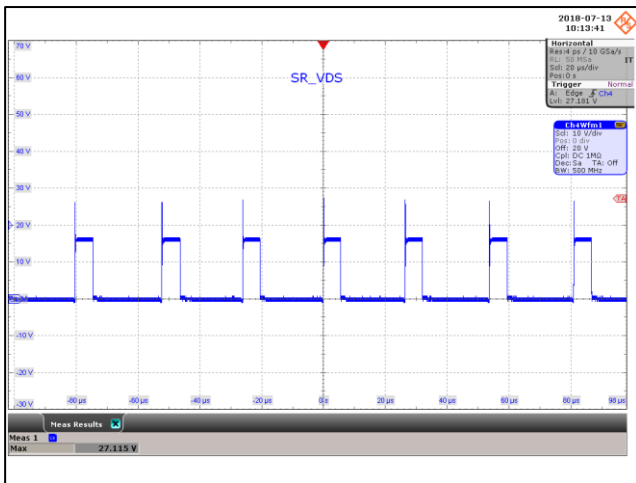

Figure 77 – SR FET Voltage Waveforms.
85 VAC, 3.0 V, 5 A Load (27.11 V_{MAX}).
SR_V_{DRAIN}, 10 V / div., 20 μs / div.

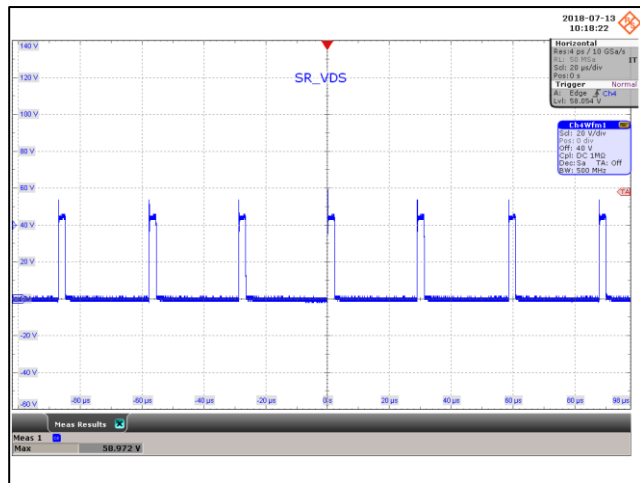

Figure 78 – SR FET Voltage Waveforms.
265 VAC, 3.0 V, 5 A Load (58.97 V_{MAX}).
SR_V_{DRAIN}, 20 V / div., 20 μs / div.

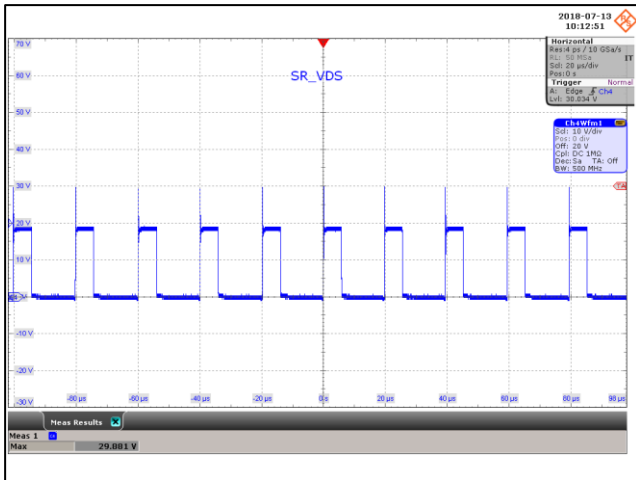

Figure 79 – SR FET Voltage Waveforms.
85 VAC, 5.0 V, 5 A Load (29.88 V_{MAX}).
SR_V_{DRAIN}, 10 V / div., 20 μs / div.

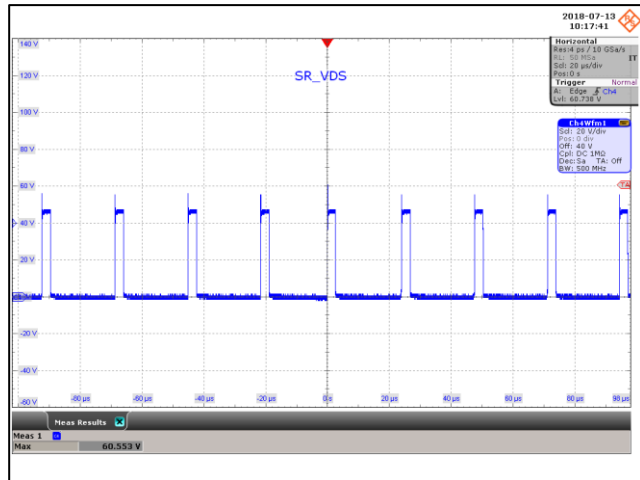

Figure 80 – SR FET Voltage Waveforms.
265 VAC, 5.0 V, 5 A Load (60.55 V_{MAX}).
SR_V_{DRAIN}, 20 V / div., 20 μs / div.

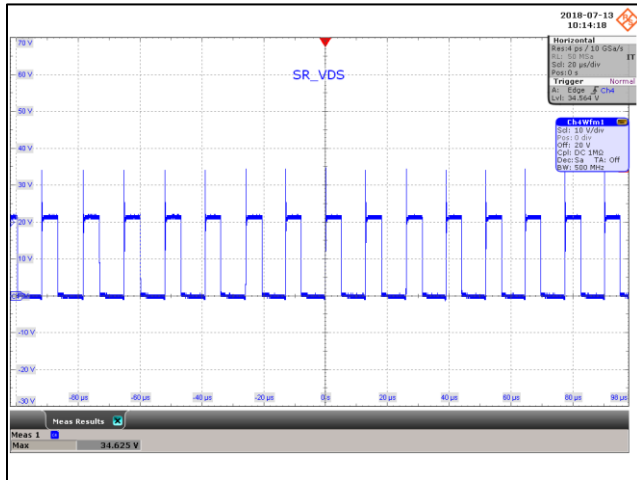

Figure 81 – SR FET Voltage Waveforms.
 85 VAC, 8.0 V, 5 A Load (34.62 V_{MAX}).
 SR_V_{DRAIN}, 10 V / div., 20 μs / div.

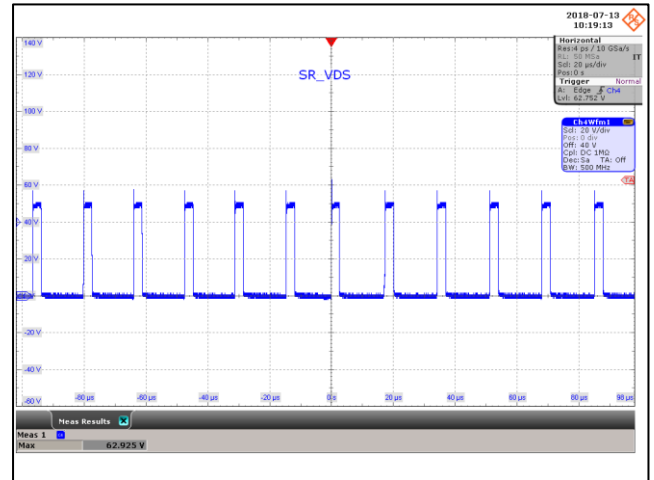

Figure 82 – SR FET Voltage Waveforms.
 265 VAC, 8.0 V, 5 A Load (62.92 V_{MAX}).
 SR_V_{DRAIN}, 20 V / div., 20 μs / div.

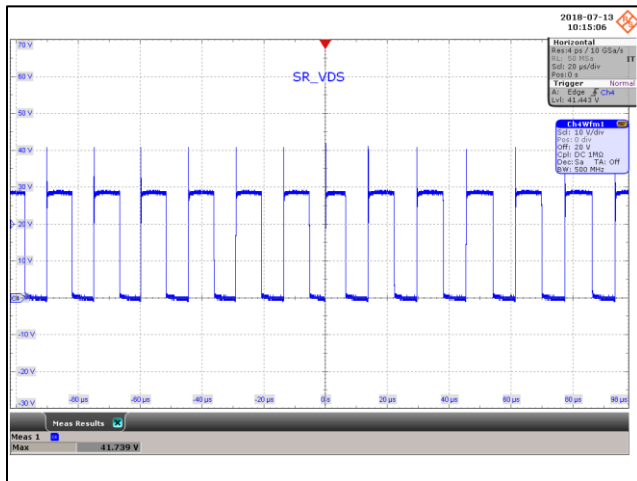

Figure 83 – SR FET Voltage Waveforms.
 85 VAC, 15.0 V, 2.66 A Load (41.73 V_{MAX}).
 SR_V_{DRAIN}, 10 V / div., 20 μs / div.

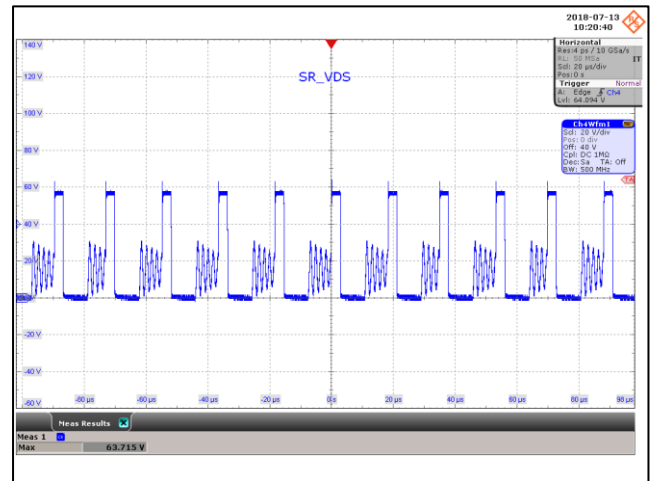

Figure 84 – SR FET Voltage Waveforms.
 265 VAC, 15.0 V, 2.66 A Load (63.71 V_{MAX}).
 SR_V_{DRAIN}, 20 V / div., 20 μs / div.



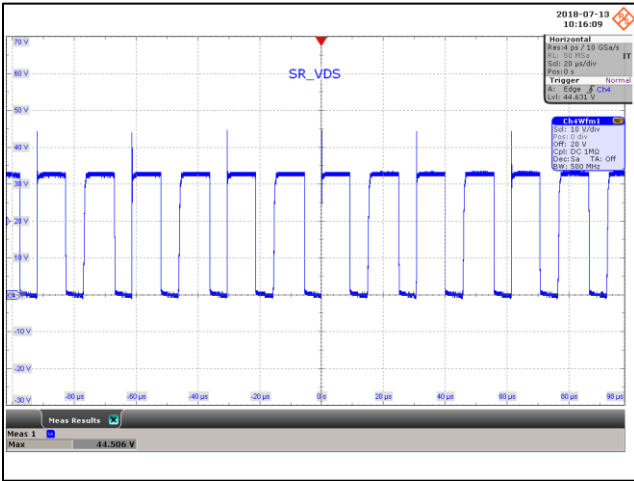

Figure 85 – SR FET Voltage Waveforms.
85 VAC, 20.0 V, 2 A Load (44.50 V_{MAX}).
SR_V_{DRAIN}, 10 V / div., 20 μs / div.

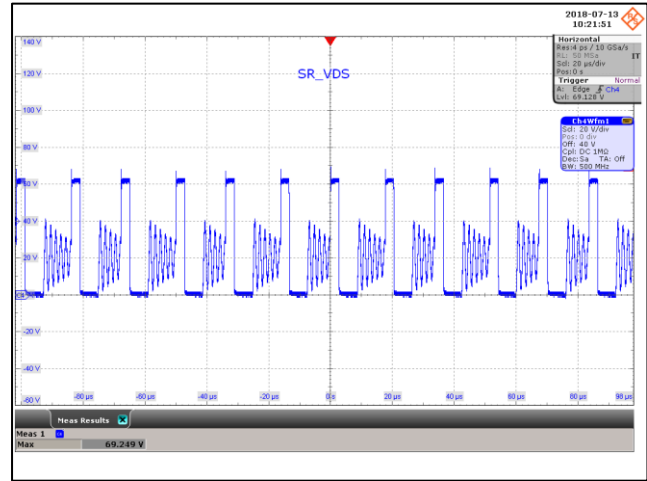

Figure 86 – SR FET Voltage Waveforms.
265 VAC, 20.0 V, 2 A Load (69.24 V_{MAX}).
SR_V_{DRAIN}, 20 V / div., 20 μs / div.

12.2.4 Output Voltage and Current Start-up (On the Board)

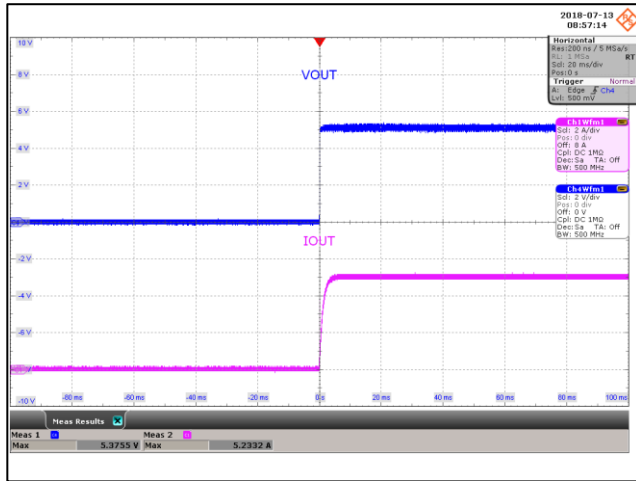

Figure 87 – Output Voltage and Current Waveforms.
85 VAC, 5 V, 5 A Load.
Upper: V_{OUT} , 2 V / div.
Lower: I_{OUT} , 2 A / div., 20 ms / div.

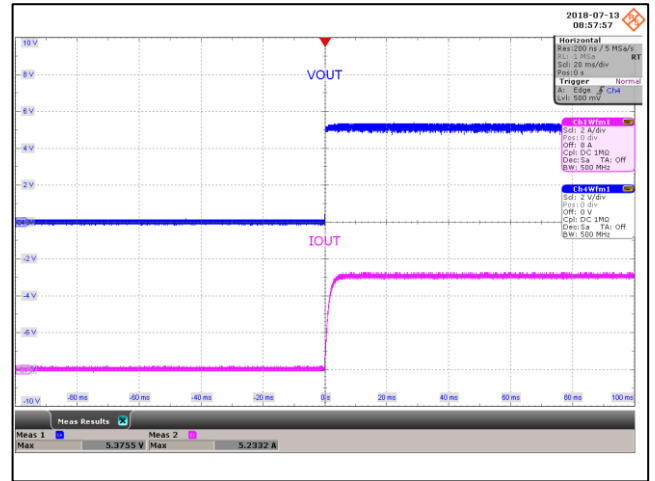

Figure 88 – Output Voltage and Current Waveforms.
265 VAC, 5 V, 5 A Load.
Upper: V_{OUT} , 2 V / div.
Lower: I_{OUT} , 2 A / div., 20 ms / div.



12.3 Output Ripple Measurements

12.3.1 Ripple Measurement Technique

For DC output ripple measurements, a modified oscilloscope test probe must be utilized in order to reduce spurious signals due to pick-up. Details of the probe modification are provided in the Figures below.

The 4987BA probe adapter is affixed with two capacitors tied in parallel across the probe tip. The capacitors include one (1) 0.1 $\mu\text{F}/50\text{ V}$ ceramic type and one (1) 47 $\mu\text{F}/50\text{ V}$ aluminum electrolytic. The aluminum electrolytic type capacitor is polarized, so proper polarity across DC outputs must be maintained (see below).

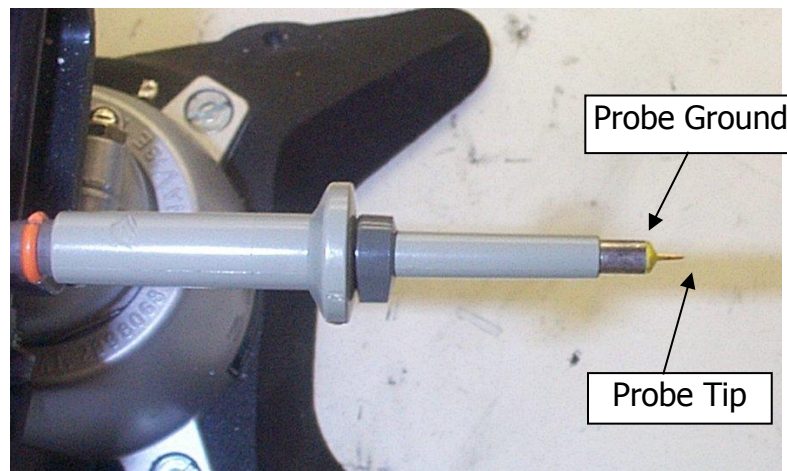

Figure 89 – Oscilloscope Probe Prepared for Ripple Measurement. (End Cap and Ground Lead Removed)

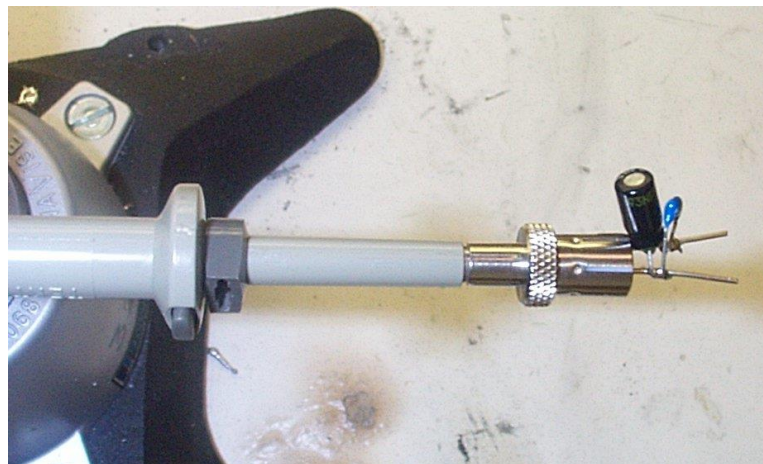

Figure 90 – Oscilloscope Probe with Probe Master (www.probemaster.com) 4987A BNC Adapter. (Modified with wires for ripple measurement, and two parallel decoupling capacitors added)

12.3.2 Ripple Amplitude vs. Line

Note: Measurements are taken at the end of 100 mΩ cable

12.3.2.1 3 V Ripple waveforms

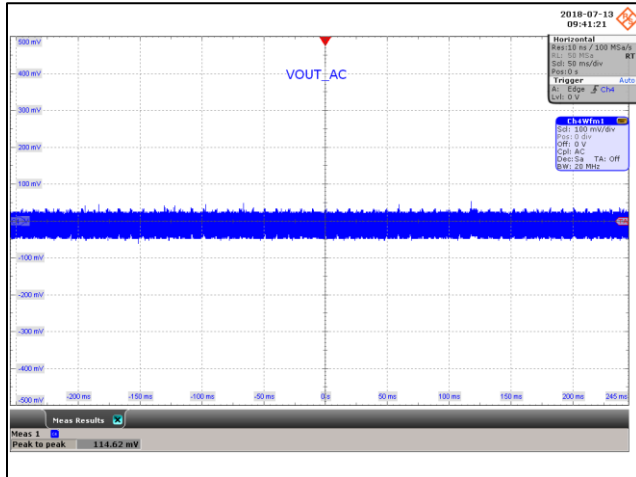

Figure 91 – Output Ripple.(PK-PK – 114 mV)
85 VAC Input 3.0 V, 5 A Load.
 V_{OUT} , 100 mV / div., 50 ms / div.

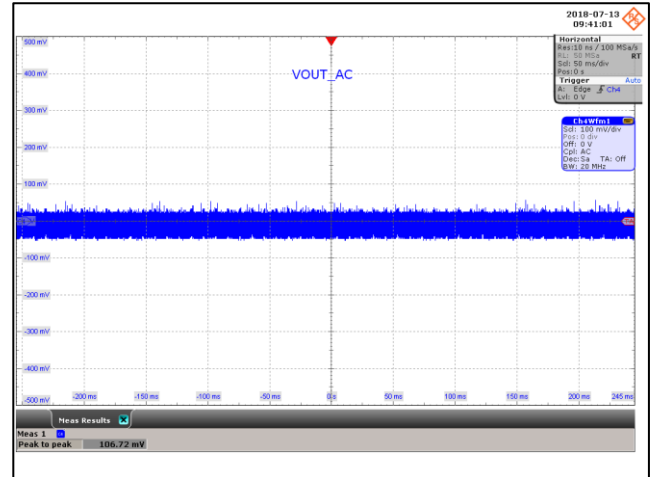

Figure 92 – Output Ripple.(PK-PK – 106 mV)
265 VAC Input 3.0 V, 5 A Load.
 V_{OUT} , 100 mV / div., 50 ms / div.

12.3.2.2 5 V Ripple waveforms

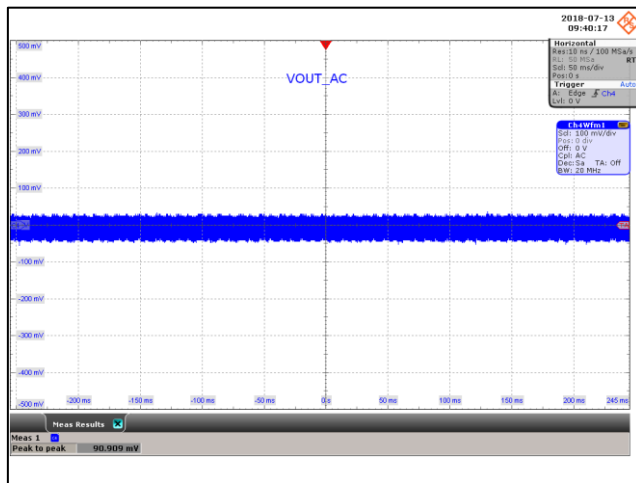

Figure 93 – Output Ripple.(PK-PK – 90 mV)
85 VAC Input 5.0 V, 5 A Load.
 V_{OUT} , 100 mV / div., 50 ms / div.

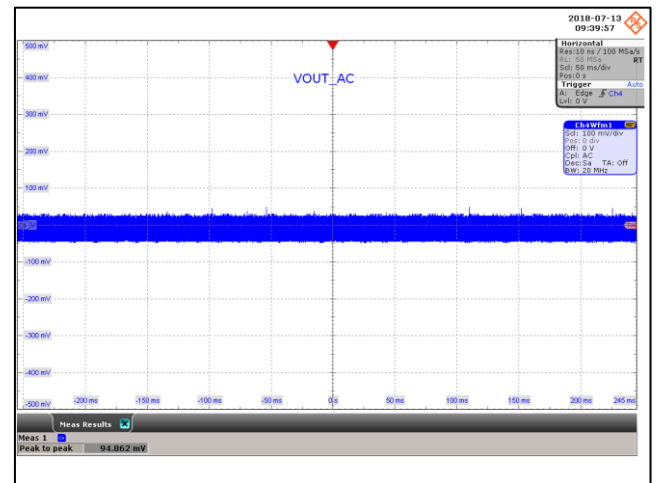

Figure 94 – Output Ripple.(PK-PK – 94 mV)
265 VAC Input 5.0 V, 5 A Load.
 V_{OUT} , 100 mV / div., 50 ms / div.



12.3.2.3 8 V Ripple Waveforms

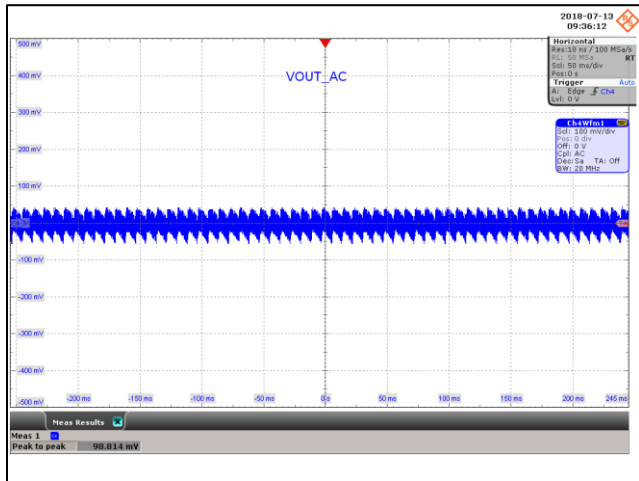

Figure 95 – Output Ripple.(PK-PK – 98 mV).
85 VAC Input 8.0 V, 5 A Load.
 V_{OUT} , 100 mV / div., 50 ms / div.

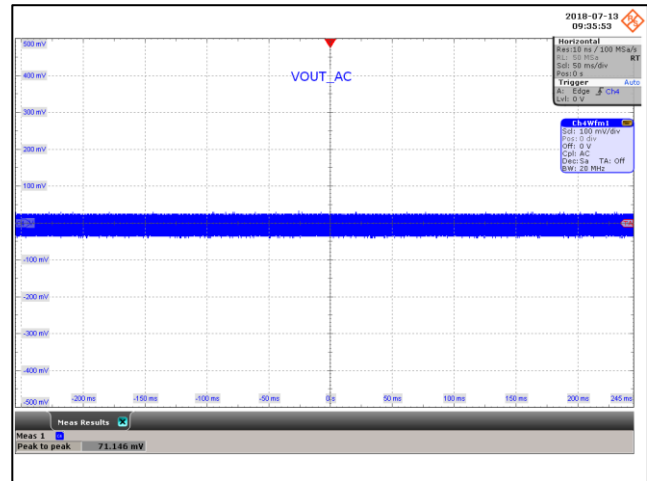

Figure 96 – Output Ripple.(PK-PK – 71 mV).
265 VAC Input 8.0 V, 5 A Load.
 V_{OUT} , 100 mV / div., 50 ms / div.

12.3.2.4 15 V Ripple Waveforms

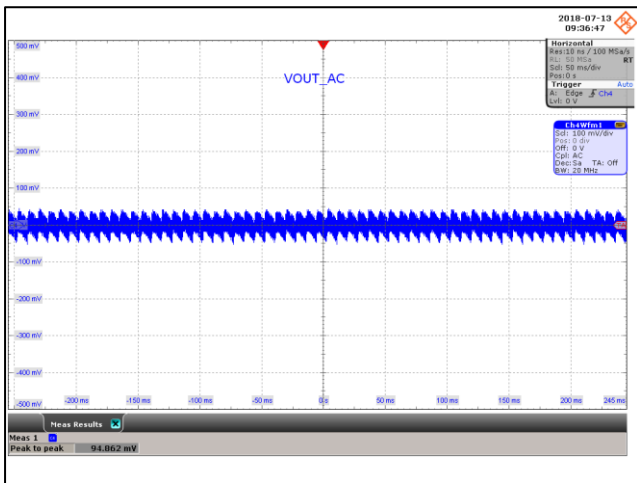

Figure 97 – Output Ripple.(PK-PK – 94 mV).
85 VAC Input 15.0 V, 2.66 A Load.
 V_{OUT} , 100 mV / div., 50 ms / div.

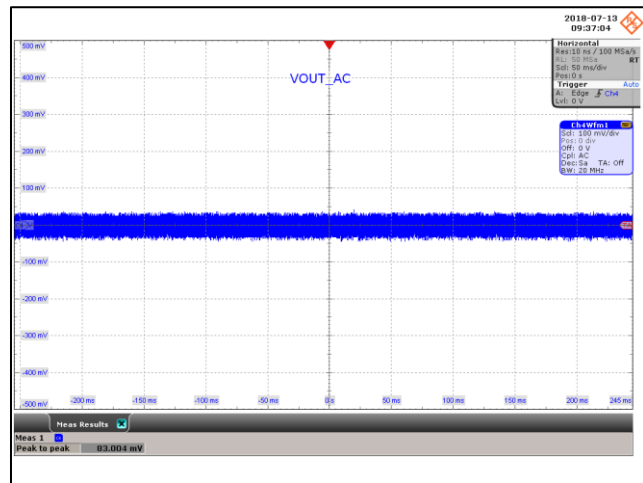

Figure 98 – Output Ripple.(PK-PK – 83 mV).
265 VAC Input 15.0 V, 2.66 A Load.
 V_{OUT} , 100 mV / div., 50 ms / div.

12.3.2.5 20 V Ripple Waveforms

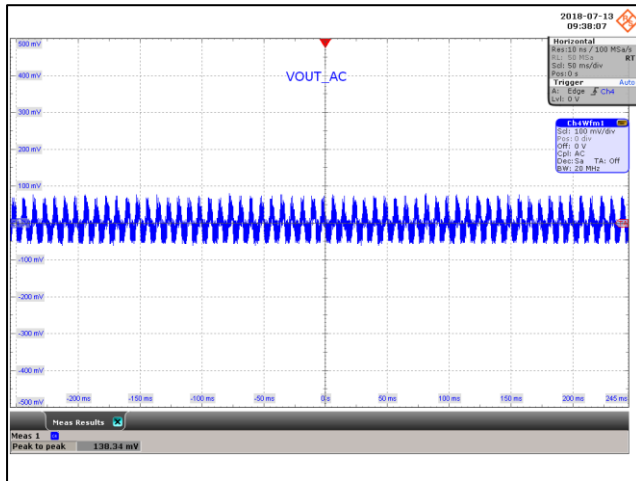

Figure 99 – Output Ripple.(PK-PK – 138 mV).
 85 VAC Input 20.0 V, 2 A Load.
 V_{OUT} , 100 mV / div., 50 ms / div.

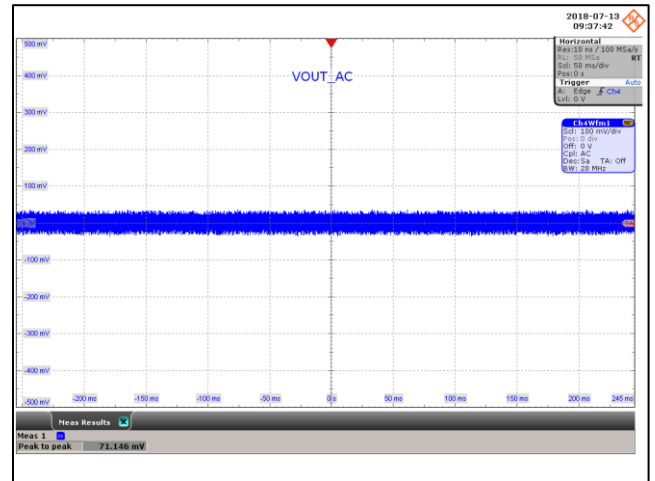

Figure 100 – Output Ripple.(PK-PK – 71 mV).
 265 VAC Input 20.0 V, 2 A Load.
 V_{OUT} , 100 mV / div., 50 ms / div.



13 Conducted EMI

13.1 Floating Output

13.1.1 Output: 8 V / 5 A

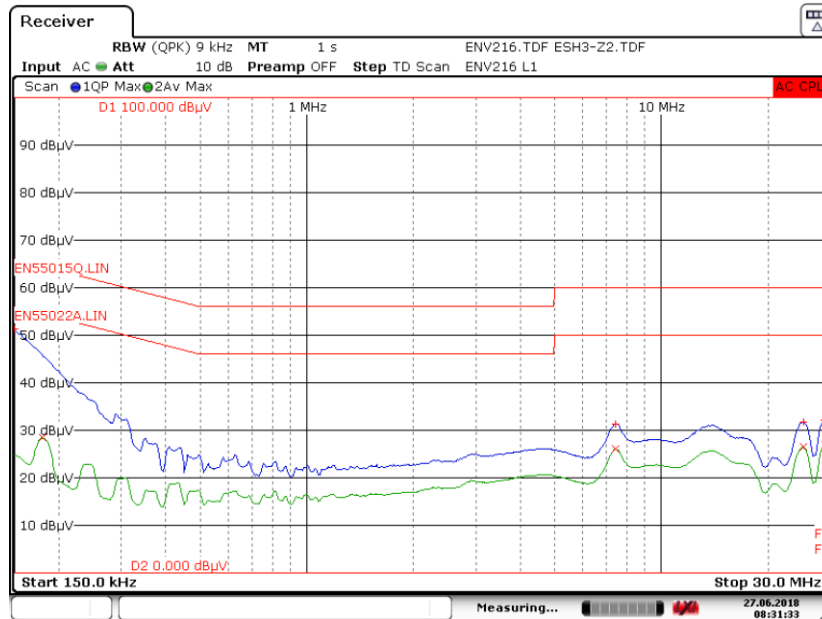

Figure 101 – Floating Ground EMI, 8 V / 5 A Load 115 VAC, 60 Hz, and EN55022 B Limits (Line).

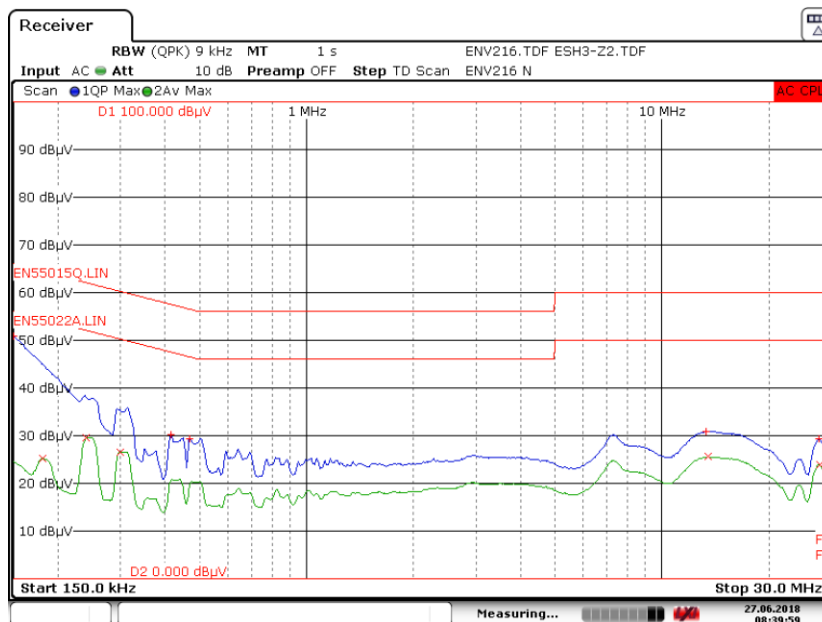

Figure 102 – Floating Ground EMI, 8 V / 5 A Load 115 VAC, 60 Hz, and EN55022 B Limits (Neutral).

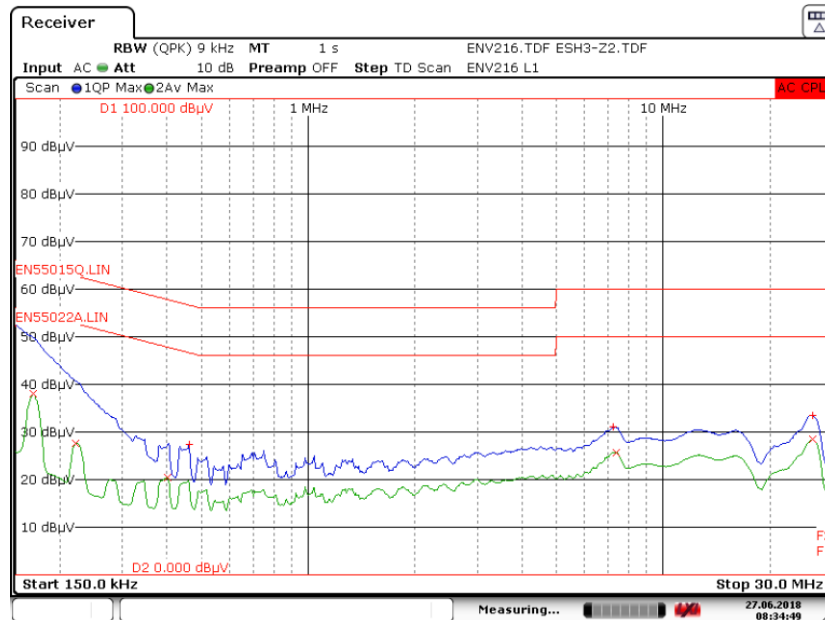

Figure 103 – Floating Ground EMI, 8 V / 5 A Load 230 VAC, 60 Hz, and EN55022 B Limits (Line).

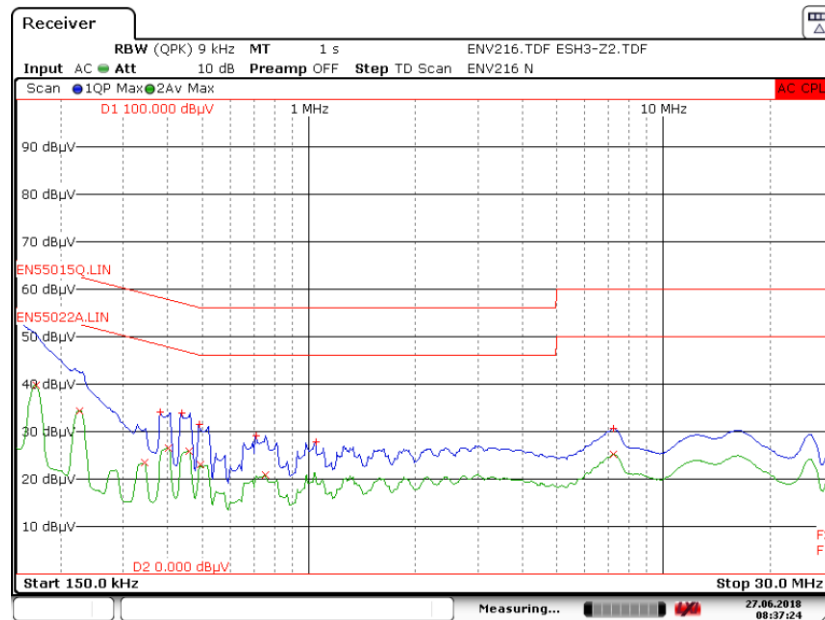

Figure 104 – Floating Ground EMI, 8 V / 5 A Load 230 VAC, 60 Hz, and EN55022 B Limits (Neutral).

13.1.2 Output: 20 V / 2 A

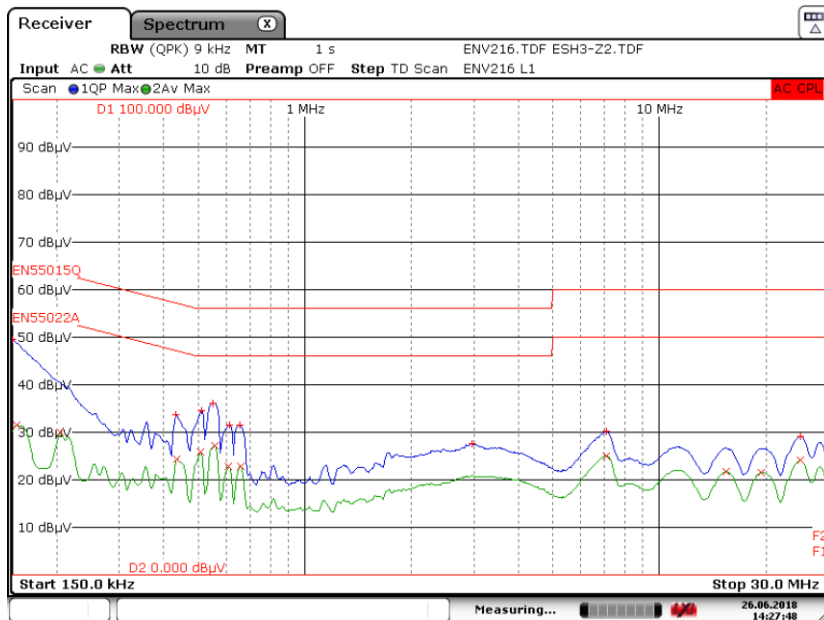

Figure 105 – Floating Ground EMI, 20 V / 2 A Load 115 VAC, 60 Hz, and EN5022 B Limits (Line).

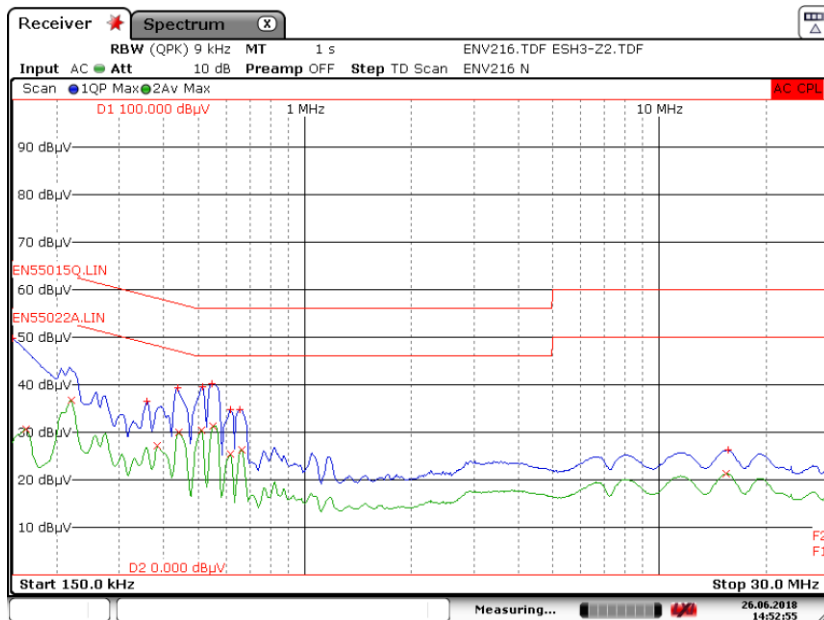

Figure 106 – Floating Ground EMI, 20 V / 2 A Load 115 VAC, 60 Hz, and EN5022 B Limits (Neutral).

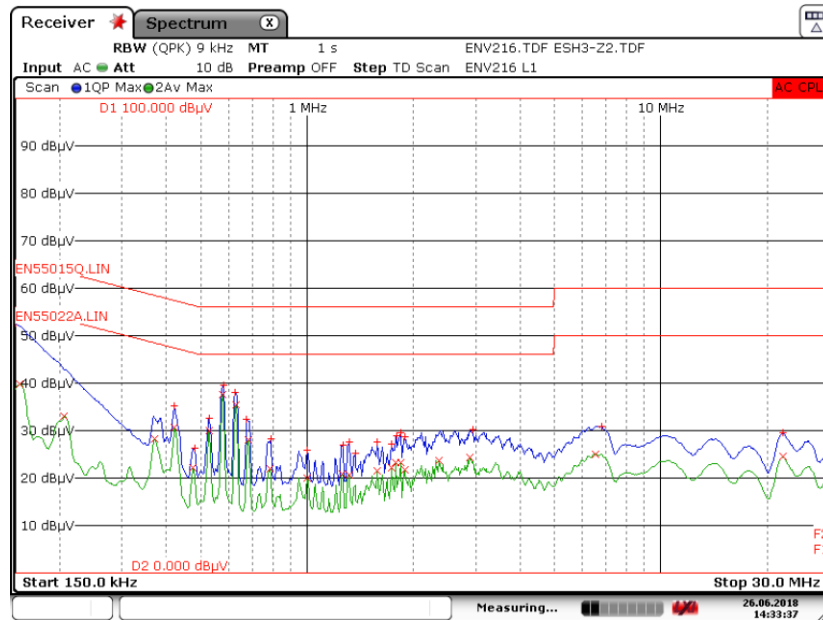

Figure 107 – Floating Ground EMI, 20 V / 2 A Load 230 VAC, 60 Hz, and EN55022 B Limits (Line).

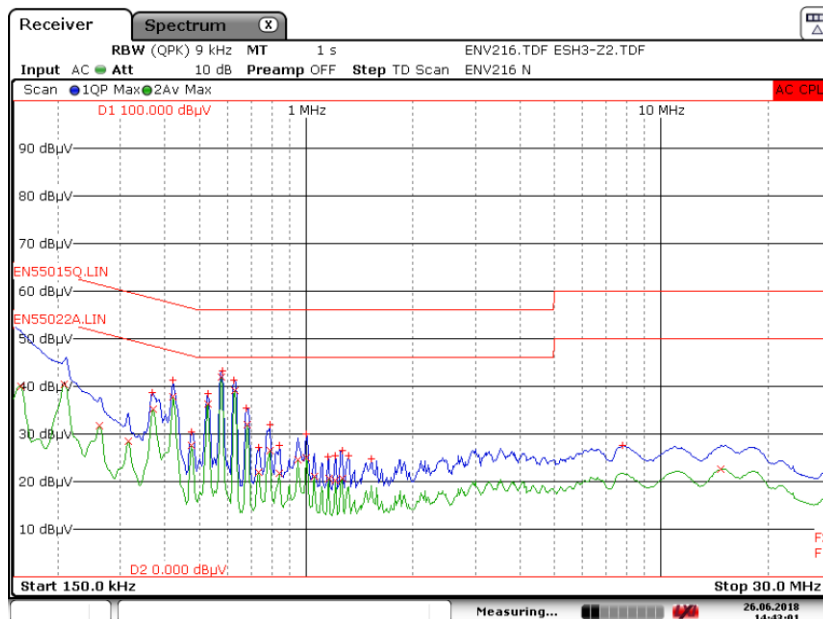

Figure 108 – Floating Ground EMI, 20 V / 2 A Load 230 VAC, 60 Hz, and EN55022 B Limits (Neutral).



13.2 Artificial Hand

13.2.1 Output: 8 V / 5 A

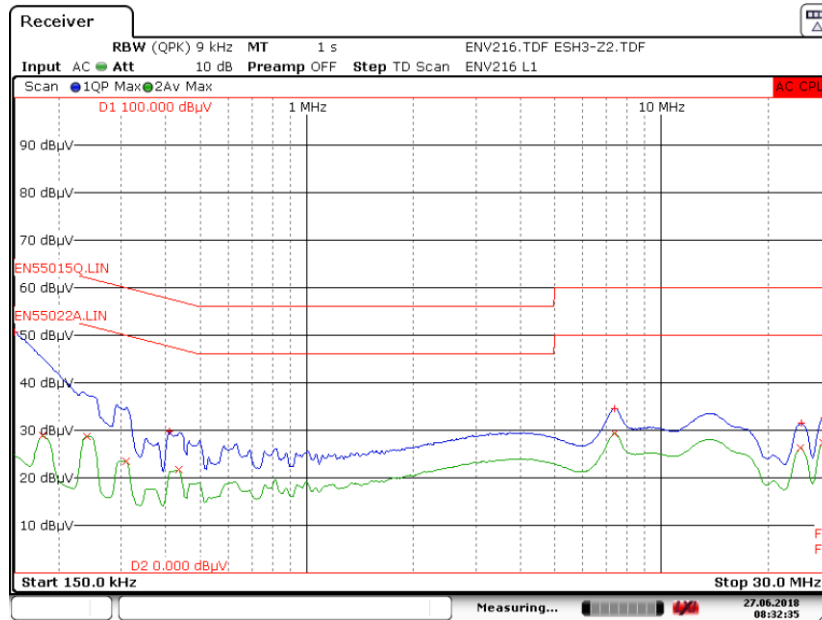

Figure 109 – Artificial Hand EMI, 8 V / 5 A Load 115 VAC, 60 Hz, and EN55022 B Limits (Line).

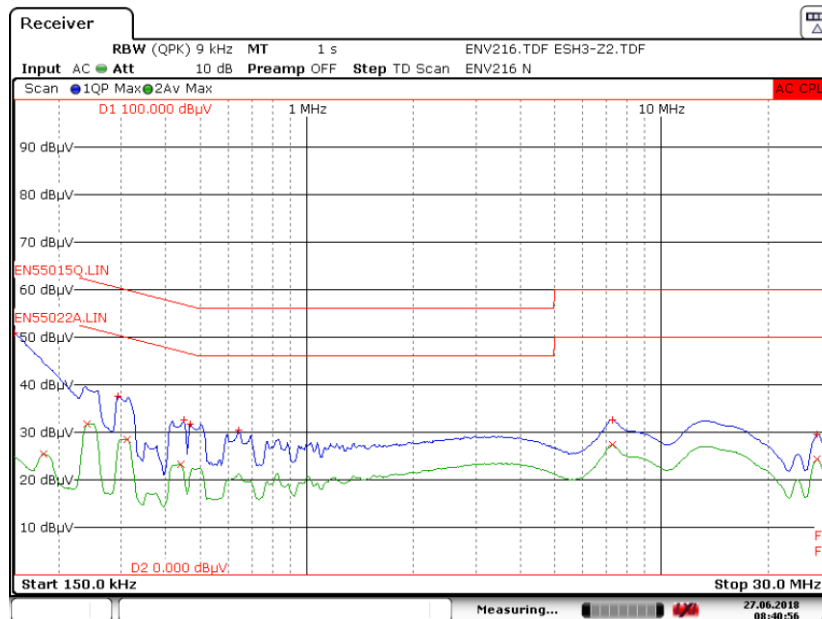

Figure 110 – Artificial Hand EMI, 8 V / 5 A Load 115 VAC, 60 Hz, and EN55022 B Limits (Neutral).

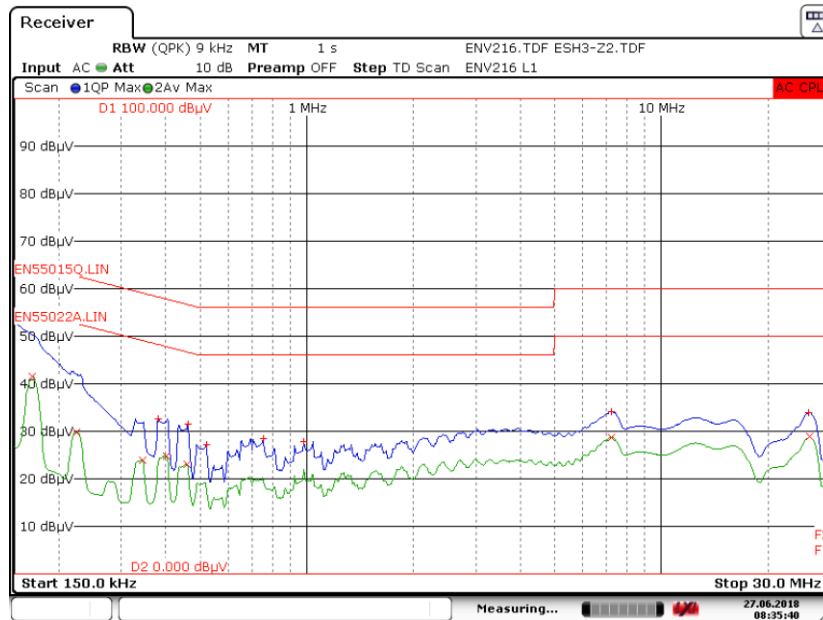

Figure 111 – Artificial Hand EMI, 8 V / 5 A Load 230 VAC, 60 Hz, and EN55022 B Limits (Line).

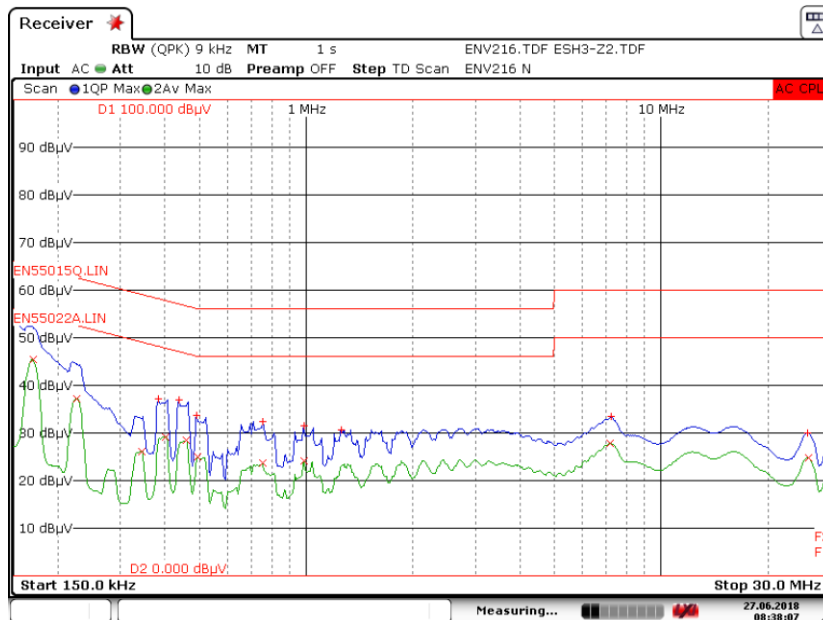

Figure 112 – Artificial Hand EMI, 8 V / 5 A Load 230 VAC, 60 Hz, and EN55022 B Limits (Neutral).

13.2.2 Output: 20 V / 2 A

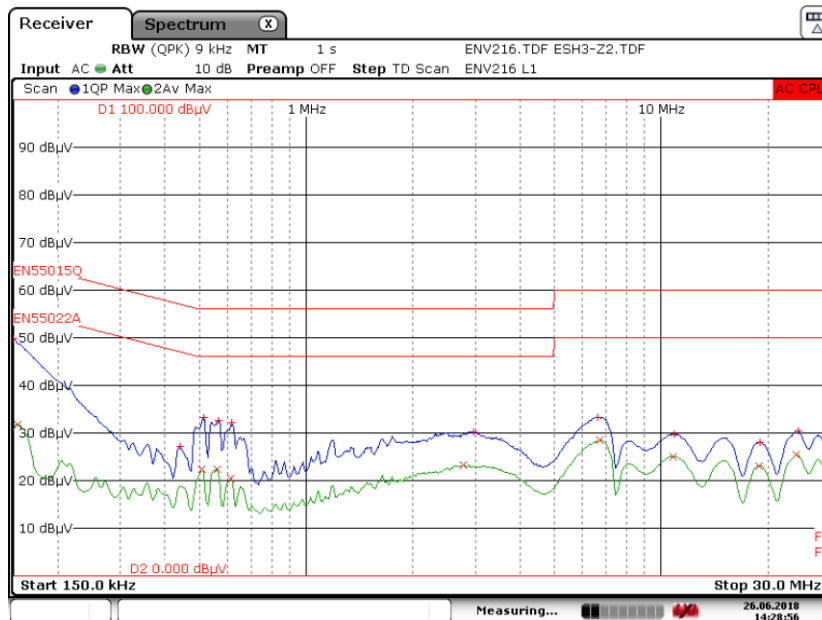

Figure 113 – Artificial Hand EMI, 20 V / 2 A Load 115 VAC, 60 Hz, and EN55022 B Limits (Line).

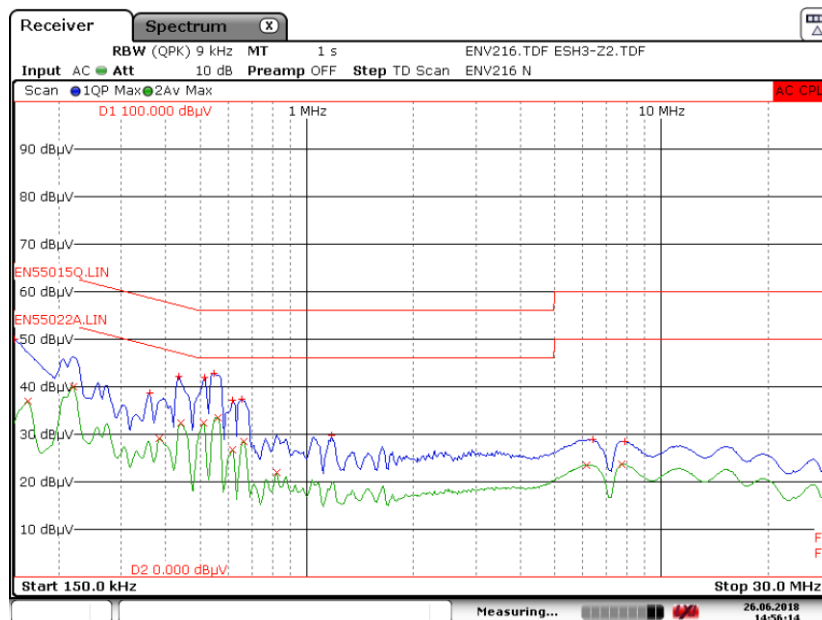

Figure 114 – Artificial Hand EMI, 20 V / 2 A Load 115 VAC, 60 Hz, and EN55022 B Limits (Neutral).

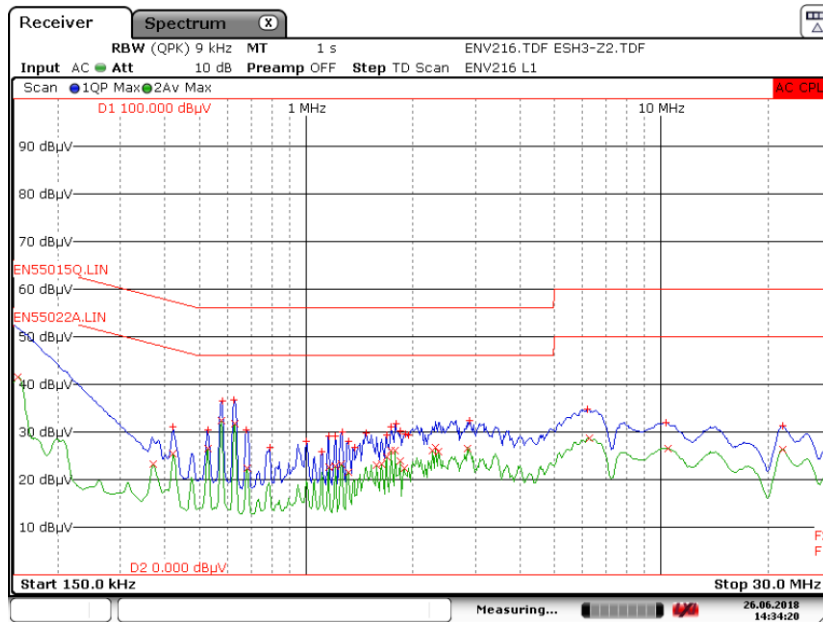

Figure 115 – Artificial Hand EMI, 20 V / 2 A Load 230 VAC, 60 Hz, and EN55022 B Limits (Line).

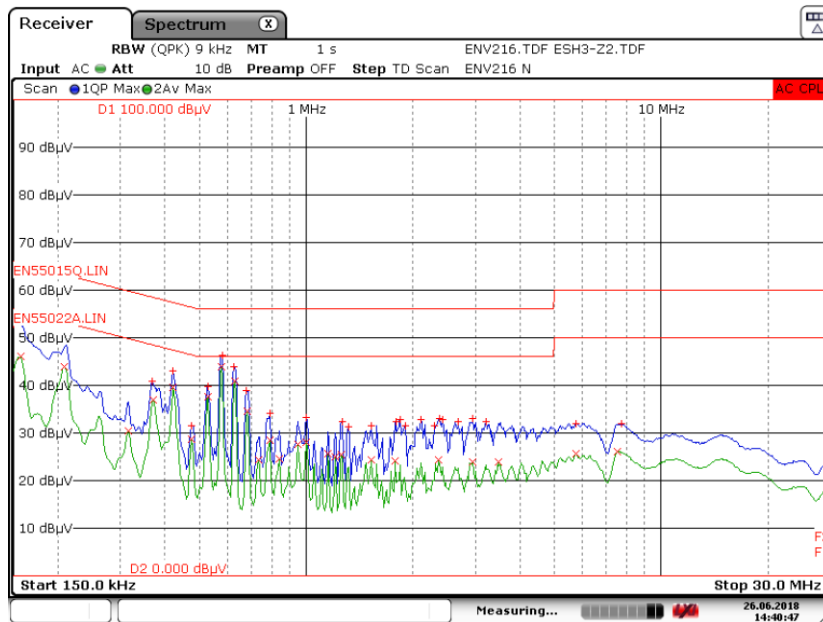

Figure 116 – Artificial Hand EMI, 20 V / 2 A Load 230 VAC, 60 Hz, and EN55022 B Limits (Neutral).



13.3 Earth Ground

13.3.1 Output: 8 V / 5 A

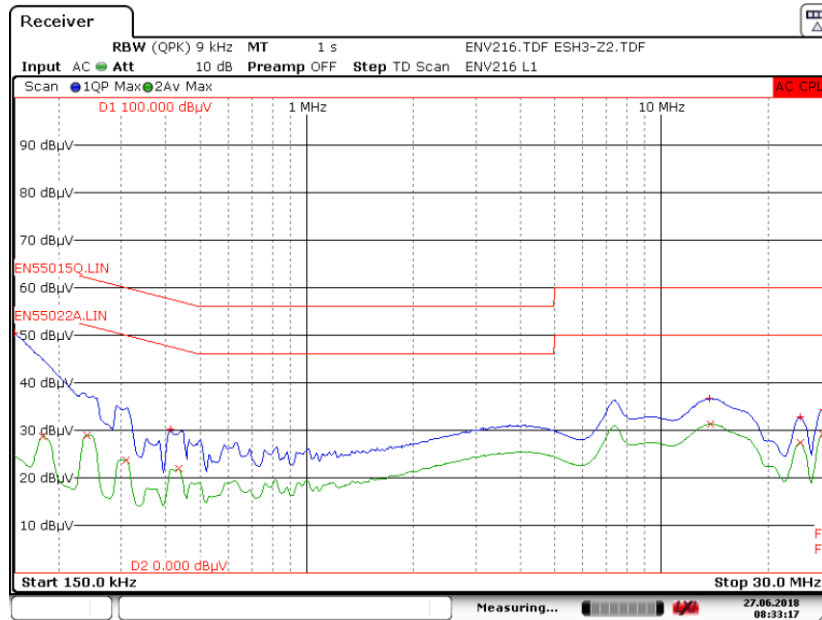

Figure 117 – Earth Ground EMI, 8 V / 5 A Load 115 VAC, 60 Hz, and EN55022 B Limits (Line).

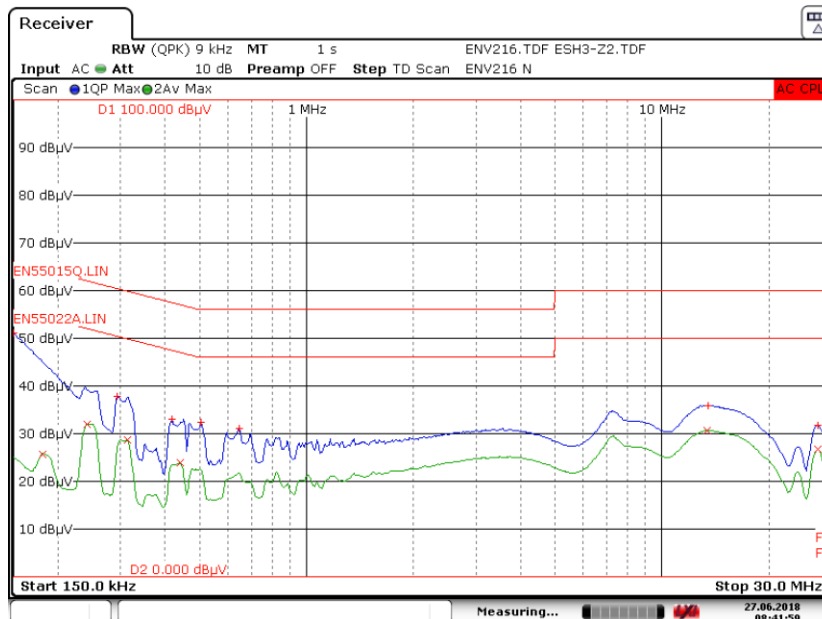

Figure 118 – Earth Ground EMI, 8 V / 5 A Load 115 VAC, 60 Hz, and EN55022 B Limits (Neutral).

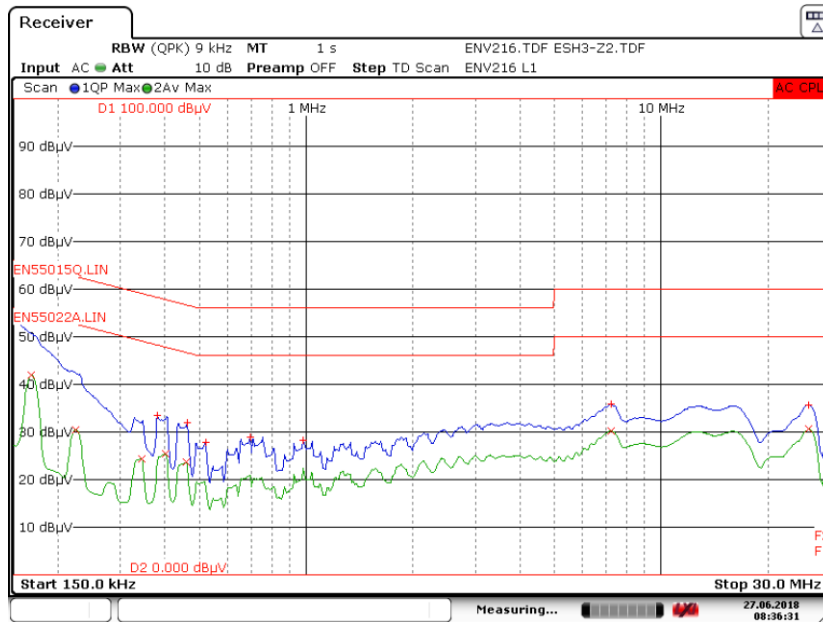

Figure 119 – Earth Ground EMI, 8 V / 5 A Load 230 VAC, 60 Hz, and EN55022 B Limits (Line).

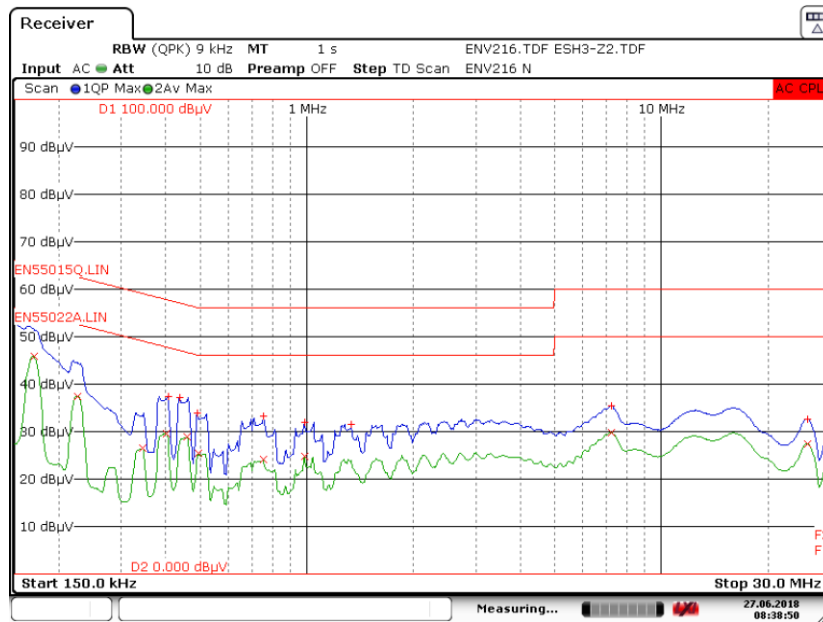

Figure 120 – Earth Ground EMI, 8 V / 5 A Load 230 VAC, 60 Hz, and EN55022 B Limits (Neutral).



13.3.2 Output: 20 V / 2 A

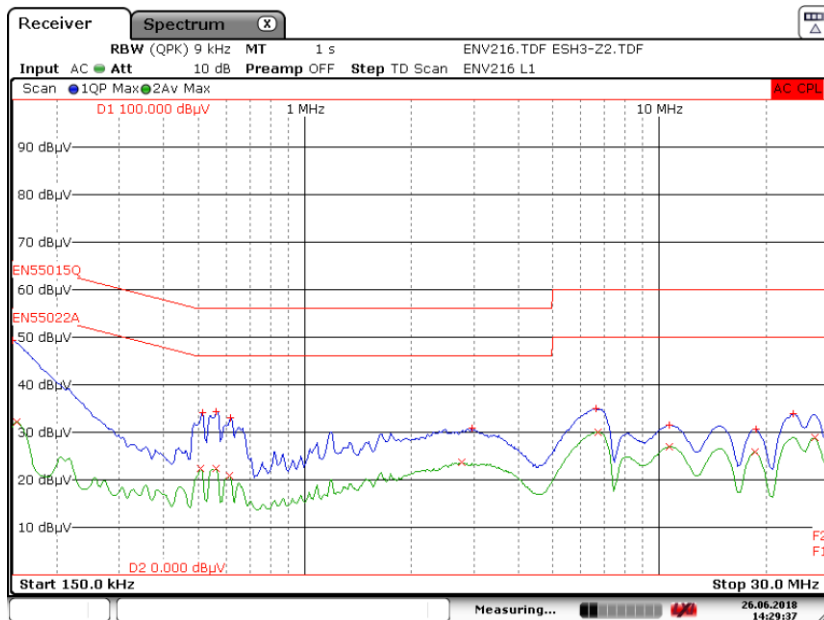

Figure 121 – Earth Ground EMI, 20 V / 2 A Load 115 VAC, 60 Hz, and EN5022 B Limits (Line).

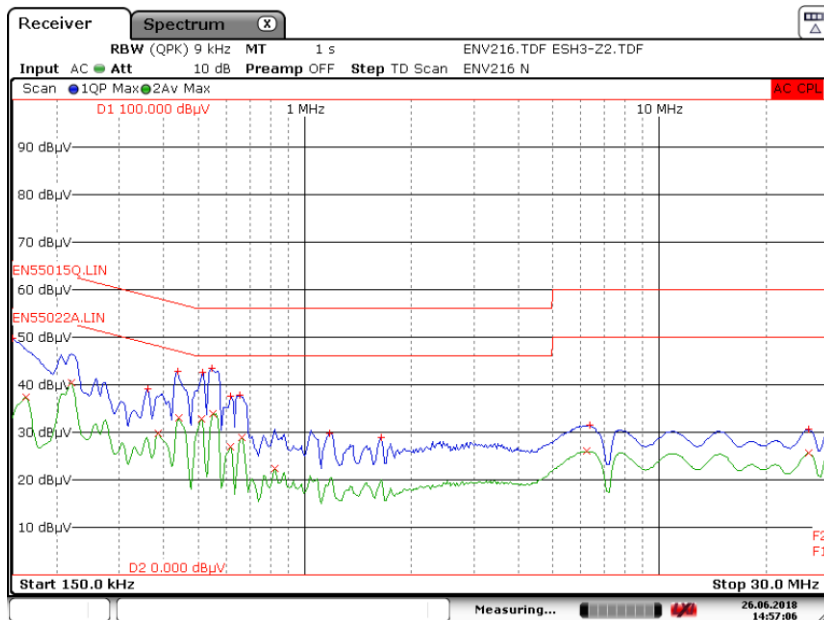

Figure 122 – Earth Ground EMI, 20 V / 2 A Load 115 VAC, 60 Hz, and EN5022 B Limits (Neutral).

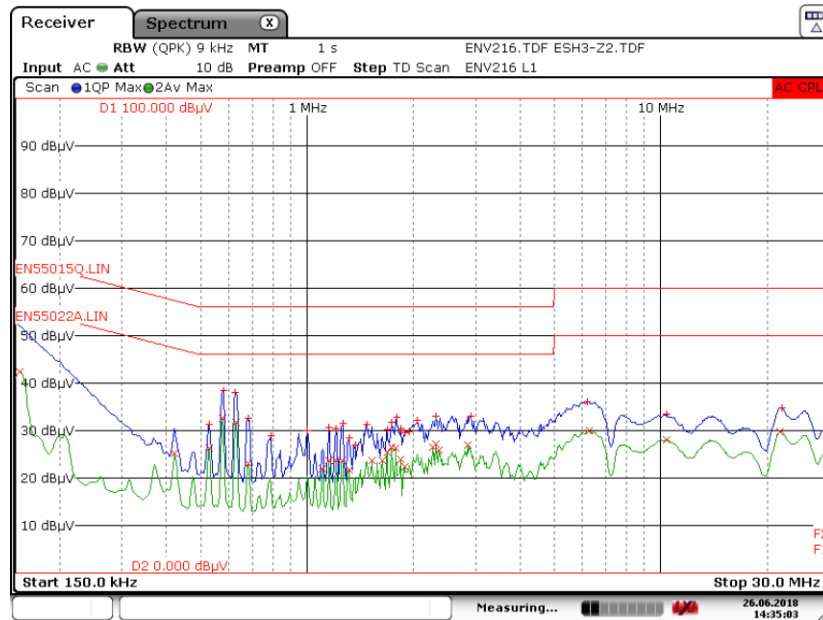

Figure 123 – Earth Ground EMI, 20 V / 2 A Load 230 VAC, 60 Hz, and EN55022 B Limits (Line).

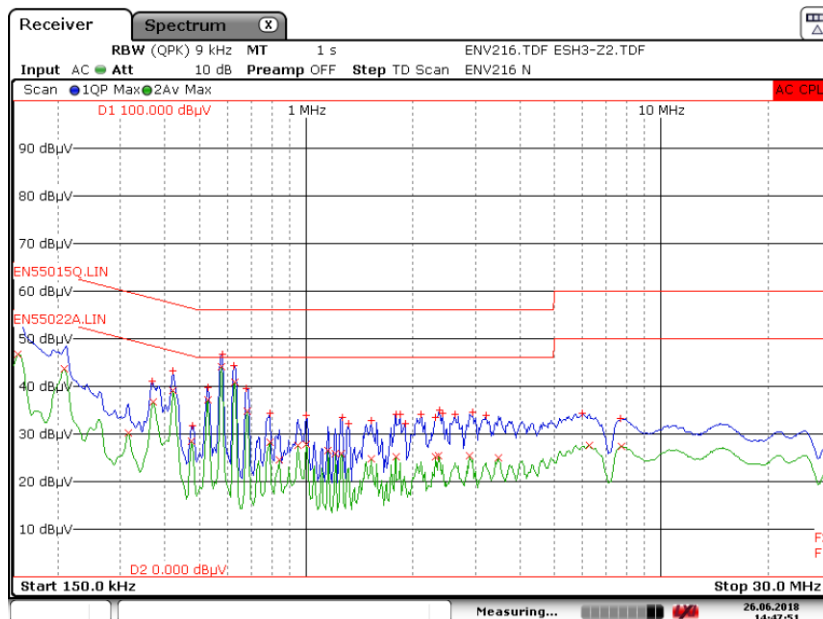

Figure 124 – Earth Ground EMI, 20 V / 2 A Load 230 VAC, 60 Hz, and EN55022 B Limits (Neutral).



14 Line Surge

The unit was subjected to ± 2000 V, common mode surge and ± 1000 V differential surge using 10 strikes at each condition. A test failure was defined as a non-recoverable interruption of output requiring repair or recycling of input voltage.

14.1 Differential Surge

Surge Level (V)	Input Voltage (VAC)	Injection Location	Injection Phase (°)	Test Result (Pass/Fail)
+1000	230	L to N	0	Pass
-1000	230	L to N	0	Pass
+1000	230	L to N	90	Pass
-1000	230	L to N	90	Pass
+1000	230	L to N	180	Pass
-1000	230	L to N	180	Pass
+1000	230	L to N	270	Pass
-1000	230	L to N	270	Pass

14.2 Common Mode Surge

Surge Level (V)	Input Voltage (VAC)	Injection Location	Injection Phase (°)	Test Result (Pass/Fail)
+2000	230	L1 to PE	0	Pass
-2000	230	L1 to PE	0	Pass
+2000	230	L1 to PE	90	Pass
-2000	230	L1 to PE	90	Pass
+2000	230	L1 to PE	180	Pass
-2000	230	L1 to PE	180	Pass
+2000	230	L1 to PE	270	Pass
-2000	230	L1 to PE	270	Pass

Surge Level (V)	Input Voltage (VAC)	Injection Location	Injection Phase (°)	Test Result (Pass/Fail)
+2000	230	L2 to PE	0	Pass
-2000	230	L2 to PE	0	Pass
+2000	230	L2 to PE	90	Pass
-2000	230	L2 to PE	90	Pass
+2000	230	L2 to PE	180	Pass
-2000	230	L2 to PE	180	Pass
+2000	230	L2 to PE	270	Pass
-2000	230	L2 to PE	270	Pass

Note: Output ground (RTN1) connected to PE.



15 Revision History

Date	Author	Revision	Description & Changes	Reviewed
01-Mar-18	CS	1.0	Initial Release.	Apps & Mktg
24-May-18	KM	1.1	Updated Figure 4.	Apps & Mktg
01-Aug-18	DB	1.2	Updated Figure 3 and the following sections: Bill of Materials, Performance Data, Thermal Performance in Open Case, Waveforms, Conducted EMI, and Line Surge.	Apps & Mktg
27-Jul-18	CS	1.3	Added Alternate Part for Transformer T2. Corrected CMC L1 Inductance Value .	Apps & Mktg
10-Jun-20	KM	1.4	Updated BOM with Alternate Parts.	Apps & Mktg
16-Jun-20	KM	1.5	Updated BOM with Alternate Parts.	Apps & Mktg
17-Jun-20	KM	1.6	Updated BOM with Alternate Parts.	Apps & Mktg
24-Jun-20	KM	1.7	Updated BOM with C23.	Apps & Mktg
26-Jun-20	KM	1.8	Removed C14 and Updated Various Mfg Part numbers.	Apps & Mktg
28-Jul-20	KM	1.9	Added Q3 Alternate Part.	Apps & Mktg

For the latest updates, visit our website: www.power.com

Reference Designs are technical proposals concerning how to use Power Integrations' gate drivers in particular applications and/or with certain power modules. These proposals are "as is" and are not subject to any qualification process. The suitability, implementation and qualification are the sole responsibility of the end user. The statements, technical information and recommendations contained herein are believed to be accurate as of the date hereof. All parameters, numbers, values and other technical data included in the technical information were calculated and determined to our best knowledge in accordance with the relevant technical norms (if any). They may base on assumptions or operational conditions that do not necessarily apply in general. We exclude any representation or warranty, express or implied, in relation to the accuracy or completeness of the statements, technical information and recommendations contained herein. No responsibility is accepted for the accuracy or sufficiency of any of the statements, technical information, recommendations or opinions communicated and any liability for any direct, indirect or consequential loss or damage suffered by any person arising therefrom is expressly disclaimed.

Power Integrations reserves the right to make changes to its products at any time to improve reliability or manufacturability. Power Integrations does not assume any liability arising from the use of any device or circuit described herein. POWER INTEGRATIONS MAKES NO WARRANTY HEREIN AND SPECIFICALLY DISCLAIMS ALL WARRANTIES INCLUDING, WITHOUT LIMITATION, THE IMPLIED WARRANTIES OF MERCHANTABILITY, FITNESS FOR A PARTICULAR PURPOSE, AND NON-INFRINGEMENT OF THIRD PARTY RIGHTS.

Patent Information

The products and applications illustrated herein (including transformer construction and circuits' external to the products) may be covered by one or more U.S. and foreign patents, or potentially by pending U.S. and foreign patent applications assigned to Power Integrations. A complete list of Power Integrations' patents may be found at www.power.com. Power Integrations grants its customers a license under certain patent rights as set forth at <http://www.power.com/ip.htm>.

The PI Logo, TOPSwitch, TinySwitch, LinkSwitch, LYTSwitch, InnoSwitch, DPA-Switch, PeakSwitch, CAPZero, SENZero, LinkZero, HiperPFS, HiperTFS, HiperLCS, Qspeed, EcoSmart, Clampless, E-Shield, Filterfuse, FluxLink, StackFET, PI Expert and PI FACTS are trademarks of Power Integrations, Inc. Other trademarks are property of their respective companies. ©Copyright 2015 Power Integrations, Inc.

Power Integrations Worldwide Sales Support Locations**WORLD HEADQUARTERS**

5245 Hellyer Avenue
San Jose, CA 95138, USA.
Main: +1-408-414-9200
Customer Service:
Phone: +1-408-414-9665
Fax: +1-408-414-9765
e-mail: usasales@power.com

GERMANY

(IGBT Driver Sales)
HellwegForum 1
59469 Ense, Germany
Tel: +49-2938-64-39990
Email: igbt-driver.sales@power.com

KOREA

RM 602, 6FL
Korea City Air Terminal B/D,
159-6
Samsung-Dong, Kangnam-Gu,
Seoul, 135-728 Korea
Phone: +82-2-2016-6610
Fax: +82-2-2016-6630
e-mail: koreasales@power.com

CHINA (SHANGHAI)

Rm 2410, Charity Plaza, No.
88,
North Caoxi Road,
Shanghai, PRC 200030
Phone: +86-21-6354-6323
Fax: +86-21-6354-6325
e-mail:
chinasales@power.com

INDIA

#1, 14th Main Road
Vasanthanagar
Bangalore-560052
India
Phone: +91-80-4113-8020
Fax: +91-80-4113-8023
e-mail:
indiasales@power.com

SINGAPORE

51 Newton Road,
#19-01/05 Goldhill Plaza
Singapore, 308900
Phone: +65-6358-2160
Fax: +65-6358-2015
e-mail:
singaporesales@power.com

CHINA (SHENZHEN)

17/F, Hivac Building, No. 2, Keji
Nan 8th Road, Nanshan District,
Shenzhen, China, 518057
Phone: +86-755-8672-8689
Fax: +86-755-8672-8690
e-mail: chinasales@power.com

ITALY

Via Milanese 20, 3rd. Fl.
20099 Sesto San Giovanni (MI)
Italy
Phone: +39-024-550-8701
Fax: +39-028-928-6009
e-mail: eurosales@power.com

TAIWAN

5F, No. 318, Nei Hu Rd.,
Sec. 1
Nei Hu District
Taipei 11493, Taiwan R.O.C.
Phone: +886-2-2659-4570
Fax: +886-2-2659-4550
e-mail: taiwansales@power.com

GERMANY

(AC-DC/LED Sales)
Lindwurmstrasse 114
80337, Munich
Germany
Phone: +49-895-527-39110
Fax: +49-895-527-39200
e-mail: eurosales@power.com

JAPAN

Kosei Dai-3 Building
2-12-11, Shin-Yokohama,
Kohoku-ku, Yokohama-shi,
Kanagawa 222-0033
Japan
Phone: +81-45-471-1021
Fax: +81-45-471-3717
e-mail: japansales@power.com

UK

Cambridge Semiconductor,
a Power Integrations company
Westbrook Centre, Block 5, 2nd
Floor
Milton Road
Cambridge CB4 1YG
Phone: +44 (0) 1223-446483
e-mail: eurosales@power.com

**Power Integrations, Inc.**

Tel: +1 408 414 9200 Fax: +1 408 414 9201
www.power.com